

AquaCare Twin

AT10,0000

ENGLISH

Dental Air Abrasion & Polishing Unit

Installation & Operation Maintenance Manual

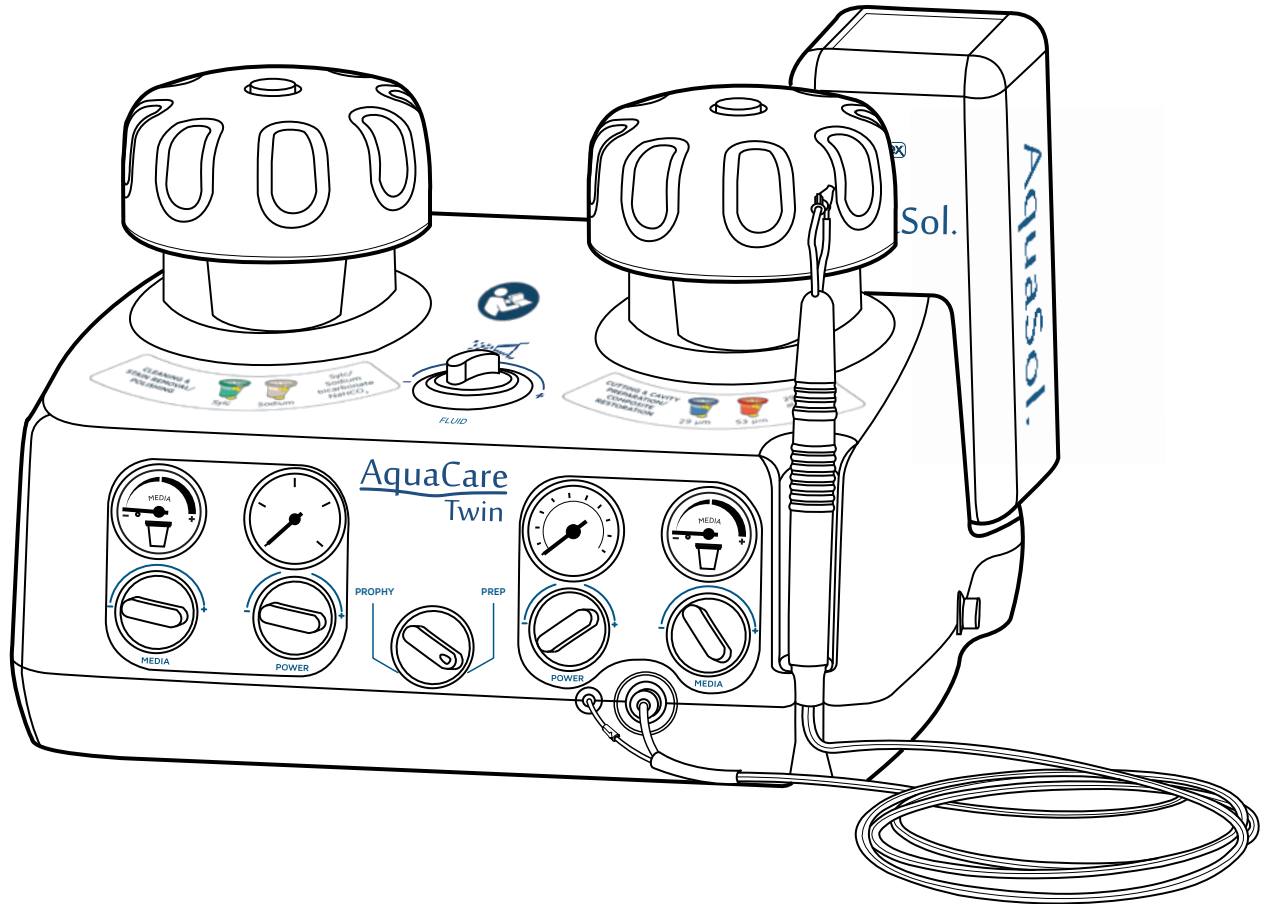

ATTENTION:
DO NOT CONNECT TO THE AIR SUPPLY BEFORE READING THIS GUIDE.



15°C



Temperature Limit



3.066KG



10%

80%

CLASS

Ila

Medical Device



AquaCare Twin
User Manual Iss. 3
I/LIT0141 Issued 01/2016



www.velopex.com



FDA 9051184

CE0120

Contents

INTRODUCTION	PAGE
CONTENTS	2-3
INDICATIONS FOR USE AND CONTRAINDICATIONS	4
SAFETY WARNINGS	5-6
TABLE OF SYMBOLS	7
TECHNICAL DESCRIPTION	8
CONTENTS OF THE PACKAGING	9
AQUACARE TWIN PARTS AND FEATURES	
EXTERNAL AQUACARE TWIN FEATURES	10
REAR VIEW OF AQUACARE TWIN	11
FOOT PEDAL	11
HANDPIECE	12
POWDER CARTRIDGES	13
INSTALLATION	
SITING THE AQUACARE TWIN	14
ATTACHING THE FOOT PEDAL	15
INSERTING THE FLUID CONTAINER	16
ASSEMBLING THE HANDPIECE	17
FITTING THE DISPOSABLE FEEDLINE AND TIP	17
CONNECTING THE AIR SUPPLY	18
INSTALLATION TEST	19
REMOVING THE DOSING CHAMBER LIDS	20
INSERTING THE POWDER CARTRIDGES	21
PREPARING THE AQUACARE TWIN FOR FIRST USE	22

Contents

OPERATION

FIRST STEPS TO MASTERING THE AQUACARE TWIN	23
SUGGESTED TREATMENT METHODS	24
PREPARATIONS BEFORE TREATMENT	25
TREATMENTS	26
- Cleaning	
- Fissure Caries	
- Cavity Preparation	
- Removal of Composite Restorations	
- Bonding Orthodontic Brackets	

MAINTENANCE

STERILISING THE HANDPIECE	31
HANDPIECE MAINTENANCE	32
TWIN TUBE ASSEMBLY MAINTENANCE	32
PURGING THE AQUACARE TWIN	33
CLEANING THE AQUACARE TWIN	34

TROUBLESHOOTING

35-37

SERVICE

ANNUAL SERVICE AND SAFETY CHECK	38
RECOMMENDED ACCESSORIES	39
NOTES	40-43

Indications For Use and Contraindications

Indications For Use

The AquaCare Twin can be used for:

- Preparation for pit and fissure sealants.
- Removal of composites for restoration.
- Cavity preparation.
- Cleaning, polishing and stain removal.
- Etching of enamel, metal and porcelain.

Contraindications For Use

The AquaCare Twin is not intended for removal of calculus.

The AquaCare Twin is not intended for cutting or removal of amalgam.

Please refer to INTRODUCTION: SAFETY WARNINGS, Pg 5/6, and read these safety notes carefully before using the machine.

It is strongly recommended that initial training is carried out on glass slides and extracted teeth before patient treatment with the AquaCare Twin is attempted.

Safety Warnings

ATTENTION- Please read all the following important warnings before using the AquaCare Twin:

Only qualified dentists and dental hygienists should use the AquaCare Twin on patients.

Before using the AquaCare Twin:

- a) Read the manual thoroughly.
- b) Make sure the operator of the unit, any assistants, the patient, and anyone else in the room wear eye protection to BS EN 166 IF 4/5.
- c) Make sure the operator of the unit, any assistants, and anyone else in the room, except the patient, wear respiratory masks to BS EN 149 FF2S.
- d) Make sure you are in full control of the handpiece, and are aiming the handpiece nozzle in a safe direction.
- e) Make sure you have selected the correct powder for the treatment you are performing. Incorrect selection of powder can cause hard tissue damage.
- f) Use a high speed intra-oral aspirator during treatment. An extra-oral aspirator can be used in addition if desired.
- e) Ensure machine has adjusted to room temperature (>15°C) before operating if coming from a cold environment.

Patients should consult their physician before having treatment with the AquaCare Twin if they have:

- a) Respiratory difficulties
- b) Asthma
- c) Blocked nasal passages
- d) A cold
- e) A restricted sodium diet
- f) Any other medical problem preventing breathing through the nose.

ALWAYS AIM TOWARDS THE INCISAL EDGE OF THE TOOTH.

The AquaCare Twin may cause soft tissue damage, including inflammation, bleeding, and creation of an air embolism. The AquaCare Twin may cause hard tissue damage, including etching or abrasion of enamel or exposed root surfaces of the teeth.

The disposable feedline and tip should be changed for each patient treatment to prevent cross-contamination. Ensure that new tips are fitted firmly onto the nozzle. Used feedlines and tips should be discarded. Attempts to reuse the AquaCare feedlines and tips, or to use them with any other micro abrasion machines could be hazardous.

Safety Warnings

In most cases the plastic tip should last long enough for one treatment. However, during prolonged treatments the tip may need replacing to prevent erratic flow of fluid. Do not use the handpiece if the hole in the tip of the nozzle has worn to the outer edge, or if the swan neck tube has been perforated.

Sterilise the handpiece before first use and between each patient treatment.

Fluid is supplied to the unit via the fluid bottle. The AquaCare Twin should never be connected to a running water supply as this will flood the machine. To rectify this the machine will require a full service and rebuild - this will be carried out at the customer's expense.

All powders supplied by Velopex are sterile until opened, and the containers are not reusable.

The powder lines and handpiece should be purged/primed each time you switch between the powder chambers using the powder selector dial (See MAINTENANCE: PURGING THE AQUACARE TWIN, Pg 33).

The AquaCare Twin produces fine powder dust when in use. Protect sensitive equipment from this dust.

Only use parts and consumables supplied by Velopex. Non-Velopex products may damage the unit or alter the performance. The fluid used with the machine must be a biostatic solution like the AquaSol from Velopex, see page 16.

Site the foot pedal carefully so that it cannot be operated by accident. Always close the foot pedal safety cover when not in use. Accidental operation can cause an uncontrolled and dangerous high pressure stream of abrasive powder.

Do not place the unit in direct sunlight.

When turning the AquaCare Twin on and off, ensure that the nozzle is aimed into the inlet of your evacuation unit, and that the evacuation unit is switched on.

When turning the AquaCare Twin off, wait for the machine to depressurise before attempting to remove the dosing chamber lids. Depressurising takes roughly 30 seconds.

If the AquaCare Twin is dropped or otherwise damaged, it must not be used until it has been inspected by a Velopex Representative or Authorised Distributor.

If the AquaCare Twin ceases to operate correctly, or if you experience a deterioration in performance, see TROUBLESHOOTING, Pg 35-37.

Control Symbols

OFF

Air supply off

AquaSol.

Fluid container/bottle

ON

Air supply on

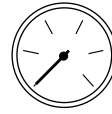

Pressure gauges



Media volume controls

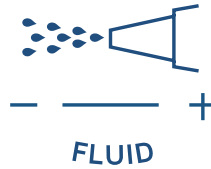

Fluid volume control



MEDIA



FLUID



POWER

Cutting speed controls



Media gauges

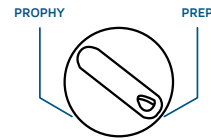

Treatment selection

Using the controls

These are the standard settings when using the machine and users can vary these settings to best suit their requirements.

Standard settings

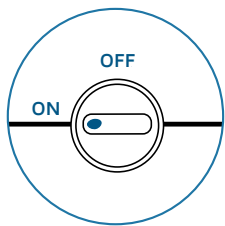

Switch on

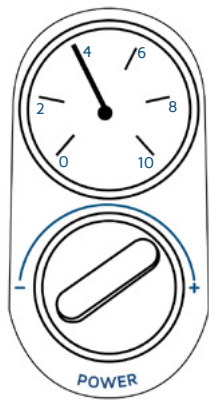

4 Bar

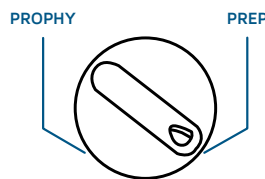

Treatment selection



As required

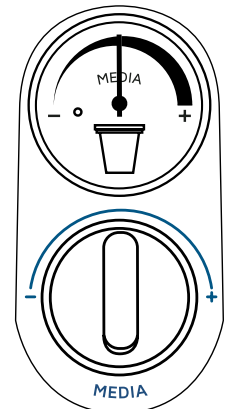

Midway Position for Polishing media & Cutting media

NOTE:

1. The Power and Media controls operate by continuous rotation (approximately 7 turns) from the minimum to maximum position.
2. The Fluid control has approximately 3 rotations from minimum to maximum position.

Technical Description

READ THIS MANUAL FULLY BEFORE ATTEMPTING TO INSTALL OR USE THE AQUACARE TWIN MACHINE.

The AquaCare Twin is a fluid abrasion unit which cuts by emitting a stream of air, fluid and powder from its handpiece. It can be loaded with two different powders for use in cutting and cleaning operations. The only supply the unit requires is clean, dry air of 5-7 bar which conforms to ISO 8573.1 class 1.4.1. The incoming air to the AquaCare Twin is internally regulated to 7 bar. The AquaCare Twin is operated by pressing the foot pedal in three modes: Dry, Wash and Cut/Clean. The air supply, power, dosing chamber, media volume, and fluid volume can all be adjusted using the seven controls available. The handpiece can be removed from the airline for sterilisation.

The overall dimensions of the AquaCare are:

Width	256mm / 10.07"
Height	165mm / 6.5"
Depth	240mm / 9.5"
Net weight	3.066kg / 6 lbs 7.6oz

The AquaCare Twin is a class IIa medical device.

ENVIRONMENTAL CONDITIONS FOR TRANSPORT AND STORAGE.

The AquaCare Twin should be kept within the Temperature range -10°C and +40°C (14°F and 104°F) and below 80% humidity.

Contents

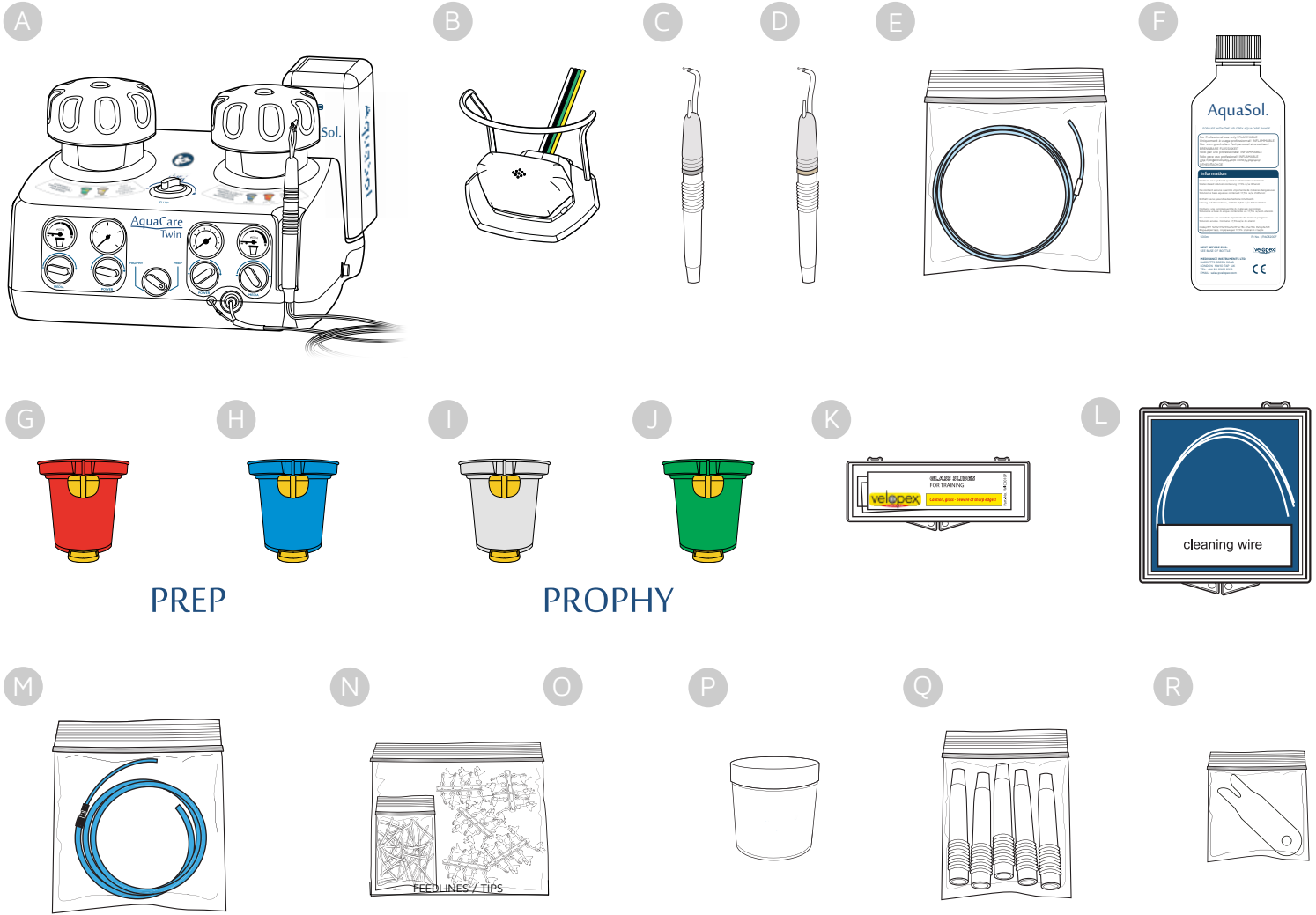

- A. 1 x AquaCare Twin air abrasion unit.
- B. 1 x Three-position foot pedal.
- C. 1 x Silver 0.6mm handpiece.
- D. 1 x Gold 0.8mm handpiece.
- E. 1 x Quick release twin feed tube assembly.
- F. 1 x 500ml AquaCare cutting fluid (AquaSol), and Replacement Lid/Seals.
- G. 1 x Cartridge of gamma irradiated aluminium oxide, 53 micron (Red).
- H. 1 x Cartridge of gamma irradiated aluminium oxide, 29 micron (Blue).
- I. 1 x Cartridge of gamma irradiated fine granular sodium bicarbonate (Clear).
- J. 1 x Cartridge of gamma irradiated Syc for AquaCare (Green).
- K. 1 x Pack of 5 glass slides.
- L. 1 x Nozzle cleaning wire.
- M. 1 x 2 metre length 4mm air input hose.
- N. 1 x Pack of 50 disposable feedlines.
- O. 1 x Pack of 50 disposable tips.
- P. 1 x Powder storage pot.
- Q. 1 x Pack of 5 spare handpiece handles.
- R. 1 x Handpiece Tube removal tool.

External AquaCare Twin Features

1. Dosing Chamber Lid - Prophy
2. Fluid Control
3. Dosing Chamber Lid - Prep
4. Fluid (500ml) Bottle
5. Handpiece Nozzle/Tip
6. Dosing Chamber - Prep
7. Handpiece
8. Handpiece Holder
9. ON/OFF Switch
10. Media Gauge - Prep
11. Media Control - Prep
12. Powder Out Connection
13. Fluid Out Connection
14. Power Control
15. Powder Chamber Selector
16. Power Control - Prophy
17. Media Control - Prophy
18. Media Gauge - Prophy
19. Air Pressure Gauge - Prophy
20. Air Pressure Gauge - Prep
21. Dosing Chamber - Prophy
22. Foot Pedal Lifting Arch
23. Foot Pedal

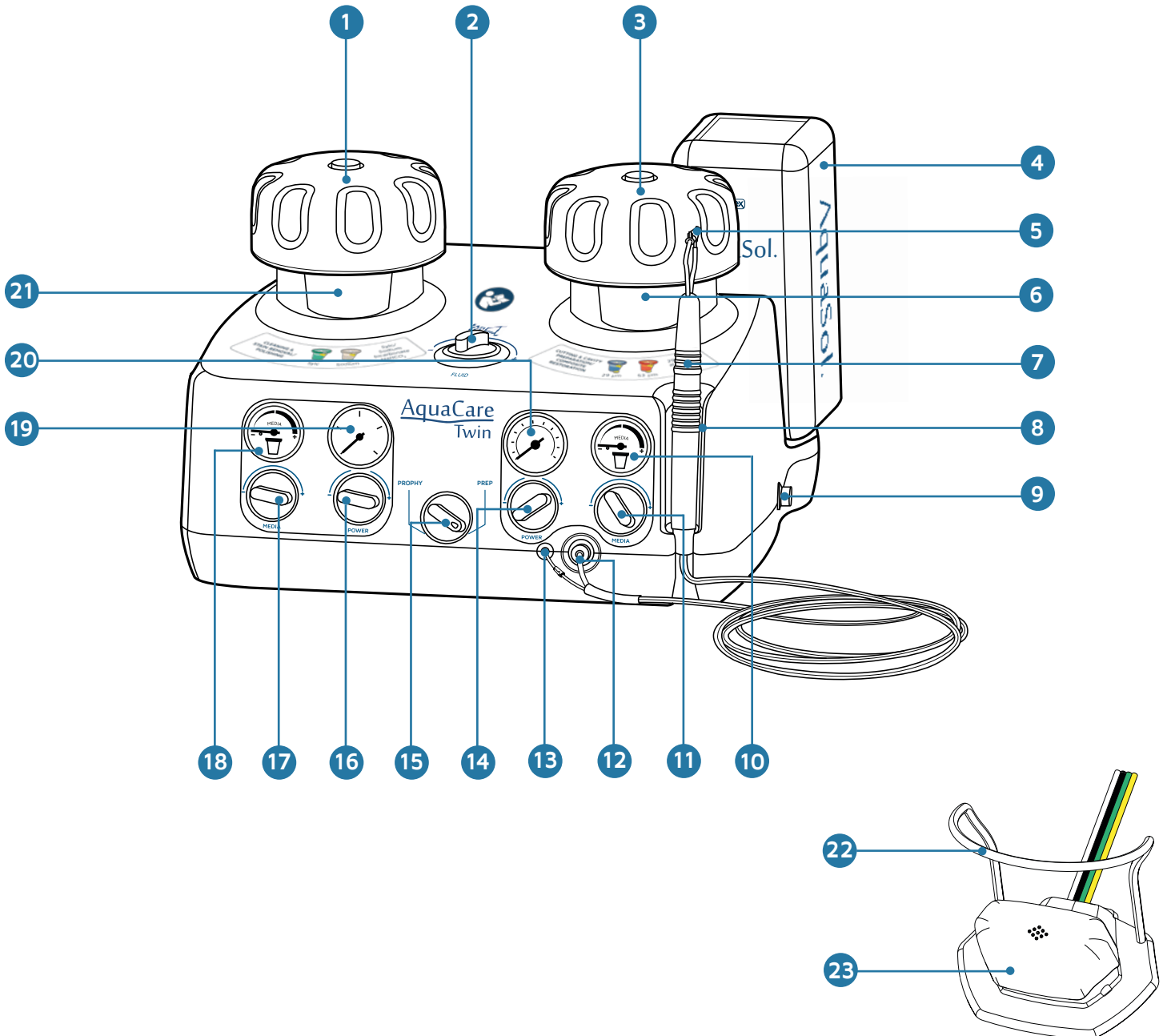

Rear View Of AquaCare Twin

- 24. Unused Connection + Blanking Plug
- 25. Foot Pedal Connection Black (4 Way Tubing)
- 26. Foot Pedal Connection White (4 Way Tubing)
- 27. Air In Supply - Blue**
- 28. Foot Pedal Connection Green (4 Way Tubing)
- 29. Foot Pedal Connection Yellow (4 Way Tubing)

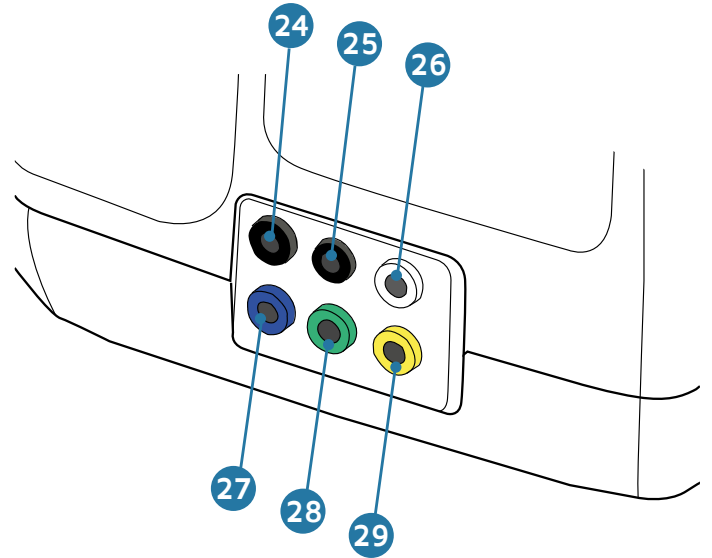
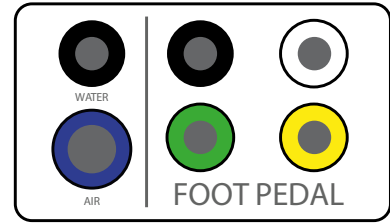

Using The Foot Pedal

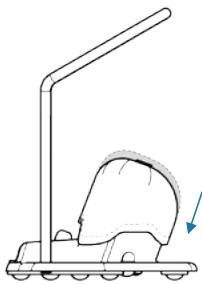

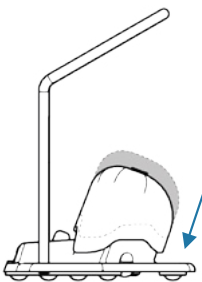

1 =  Air

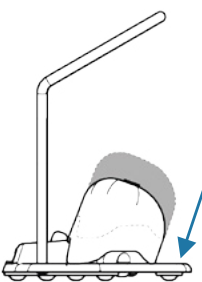

2 =  Fluid
+
 Air



3 =  Powder
+
 Fluid
+
 Air

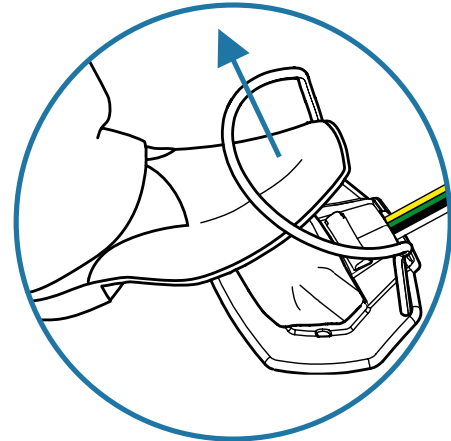

Handpiece

- 30. Fluid Connection
- 31. Feedline And Tip
- 32. Nozzle (Range Of Sizes)
- 33. Handpiece Front
- 34. Hand Grip
- 35. Powder Connection
- 36. Handle
- 37. Twin Tube
- 38. Check Valve

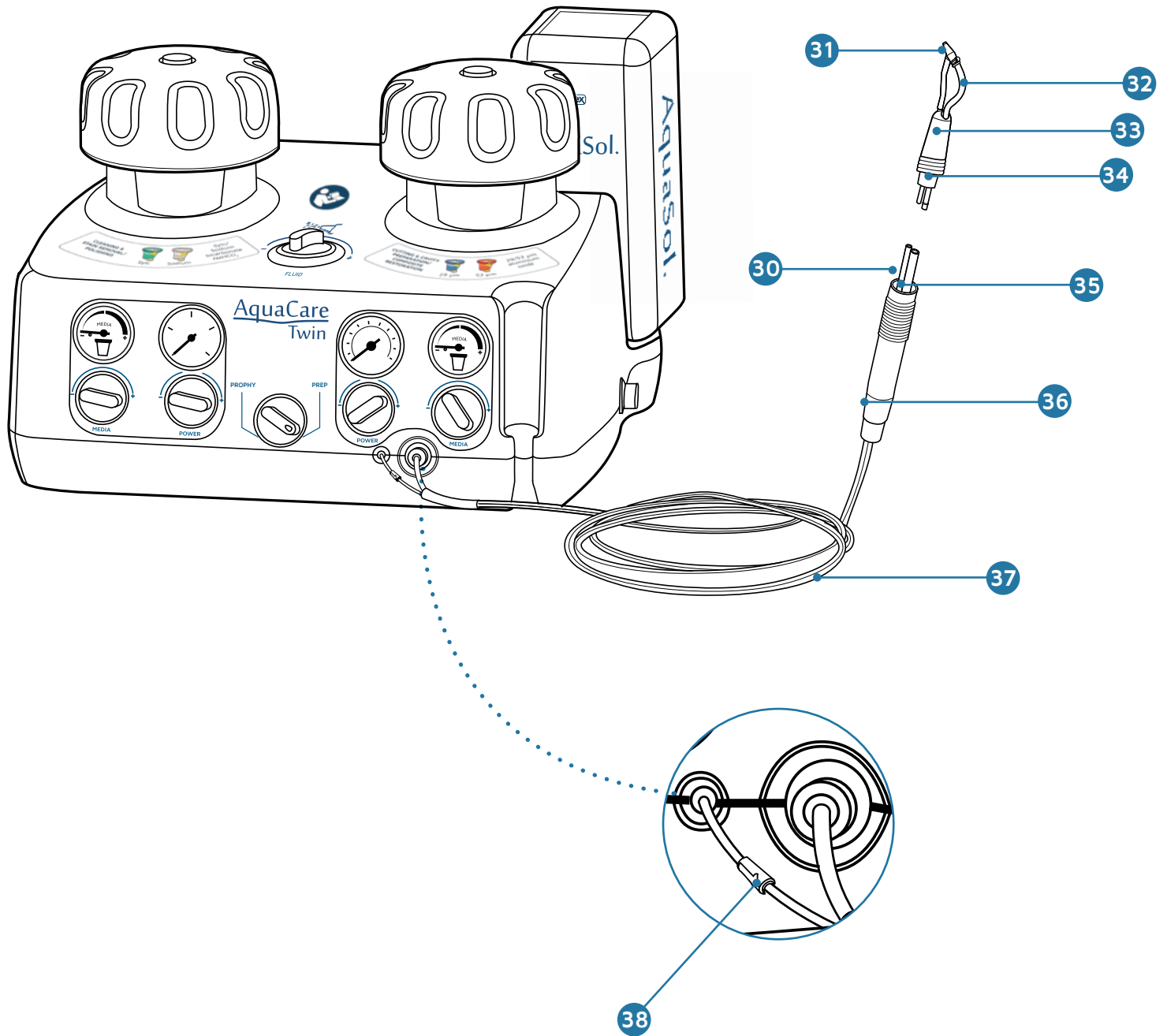

Powder Cartridges

- 39. Removed Dosing Chamber Lid - Prophy
- 40. Powder Cartridge - Prophy
- 41. Open Dosing Chamber - Prophy

- 42. Removed Dosing Chamber Lid - Prep
- 43. Powder Cartridge - Prep
- 44. Open Dosing Chamber - Prep

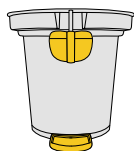
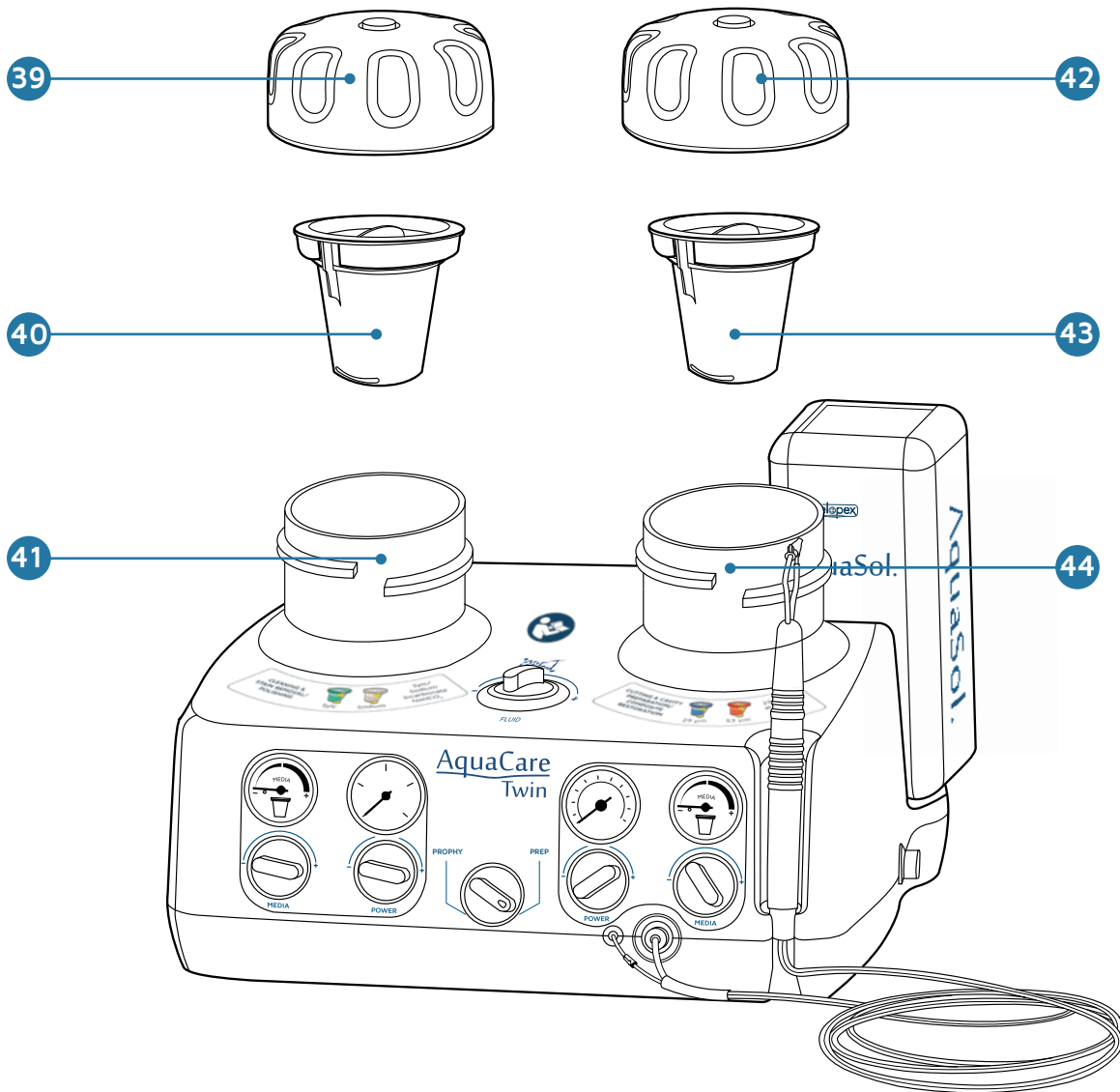

ProClean (Sodium Bicarbonate)
For cleaning and polishing



ProCut (Aluminium Oxide 29 μ)
For cutting, cavity preparation and composite preparation



ProSylc (Sylc for AquaCare™)
For cleaning and polishing



ProCut+ (Aluminium Oxide 53 μ)
For cutting, cavity preparation and composite preparation

Siting The AquaCare Twin

Remove the AquaCare Twin from its box and retain the packaging, use to return unit for service as required.

If you are using the AquaCare Twin with the Velopex Patient Treatment Centre, place the machine on the top shelf of the trolley, following the instructions received with the trolley. See RECOMMENDED ACCESSORIES, Pg 39.

If you do not have a specialised trolley, place the machine securely on a **rigid, sturdy desk** or table top.

Do not place the machine close to, or allow it to hang over, the edge of the table top. The machine is designed to have all the controls within easy reach of the dentist when situated in this way.

The unit should be kept within a temperature range of +15°C and +40°C, and should also be kept below 80% humidity.

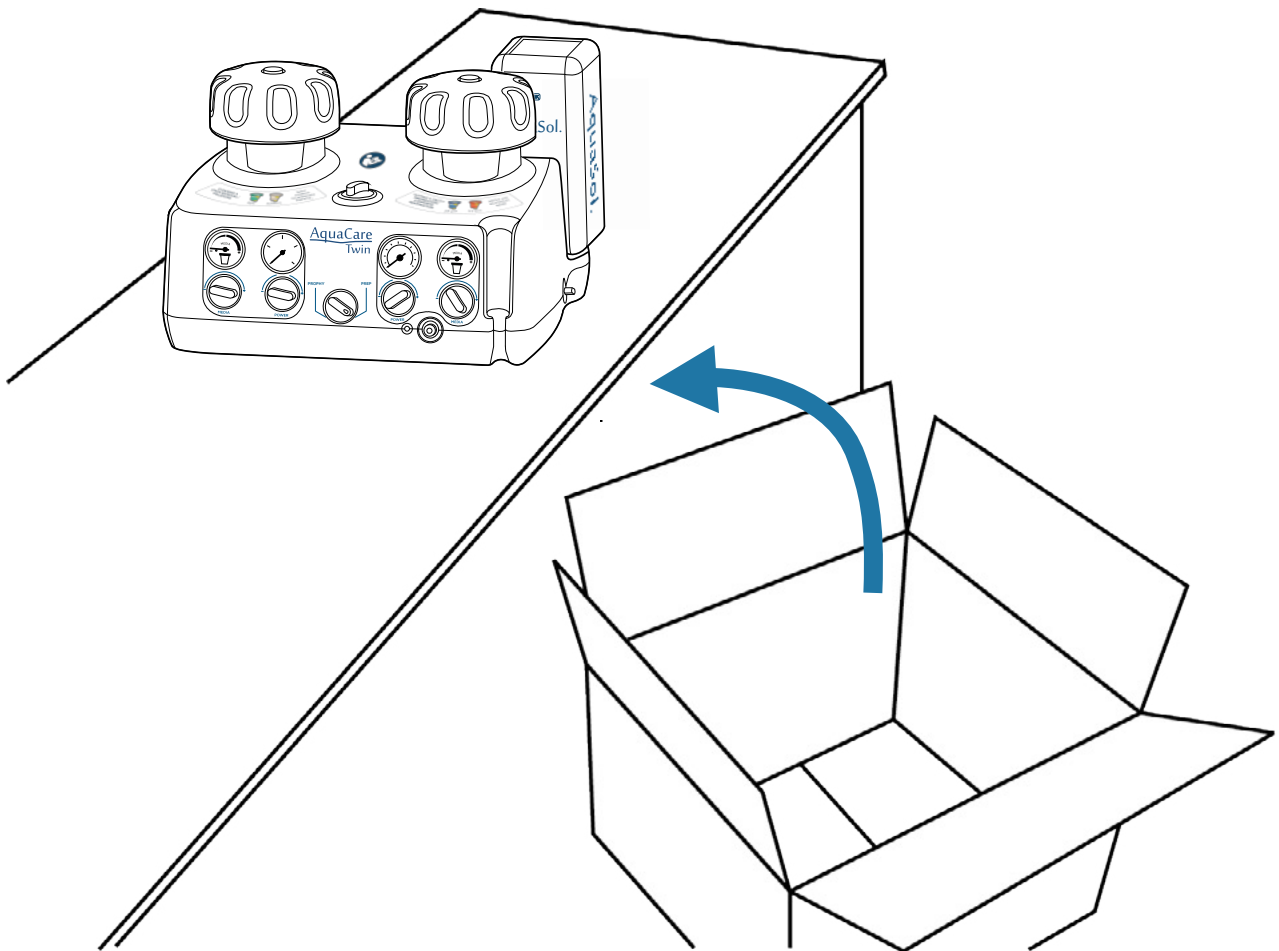

Attaching the foot pedal

WARNING: Accidental operation of the foot pedal can be hazardous. To avoid this, make sure the foot pedal is always under strict control when the unit is on.

- A. See PARTS AND FEATURES: FOOT PEDAL, Pg11. Place the foot pedal on the floor near the machine and within easy reach of the dentist.
- B. Connect the foot pedal to the back of the machine by pushing each coloured tube into its colour-corresponding connector.

TIP: To disconnect, push the coloured connector into the machine, and gently pull the tube out.

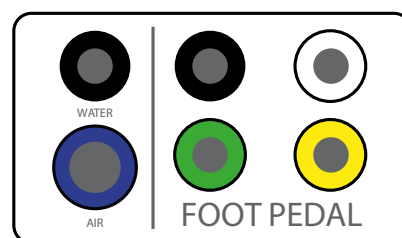
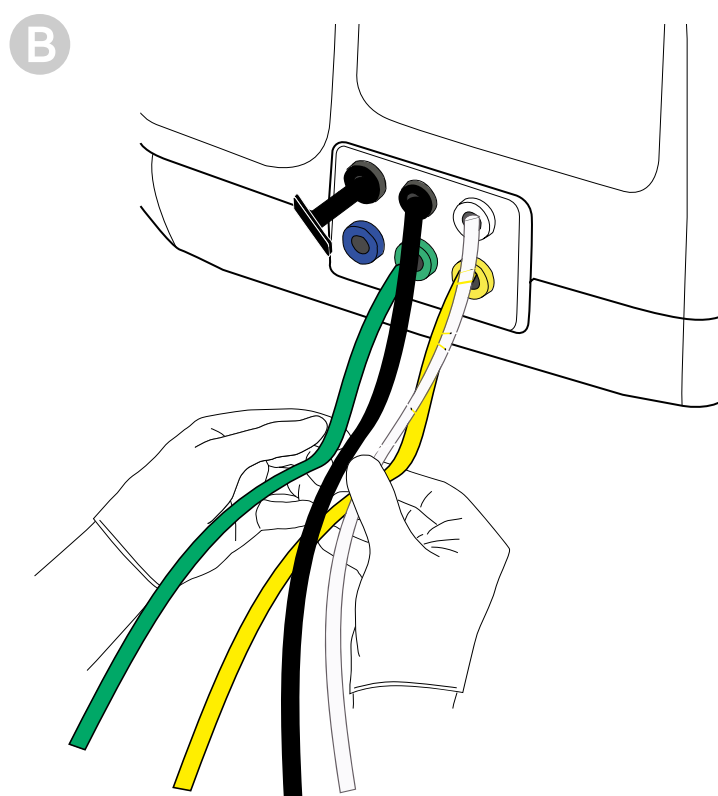
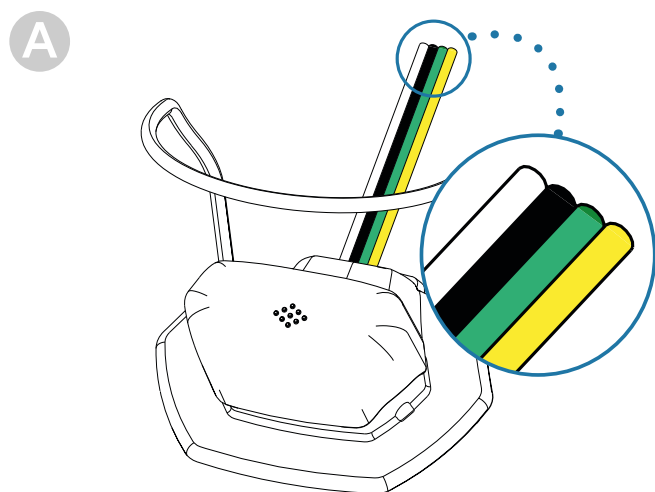

Inserting the fluid container

Holding the fluid container with the lid upward, peel off the label as shown in figure B, then turn the container over and insert into the rear water socket as shown in figure C. Push down with light pressure to ensure that the needle punctures the seal.

NOTE: The containers are NOT refillable and must be replaced as required, remove the empty container and replace as shown.

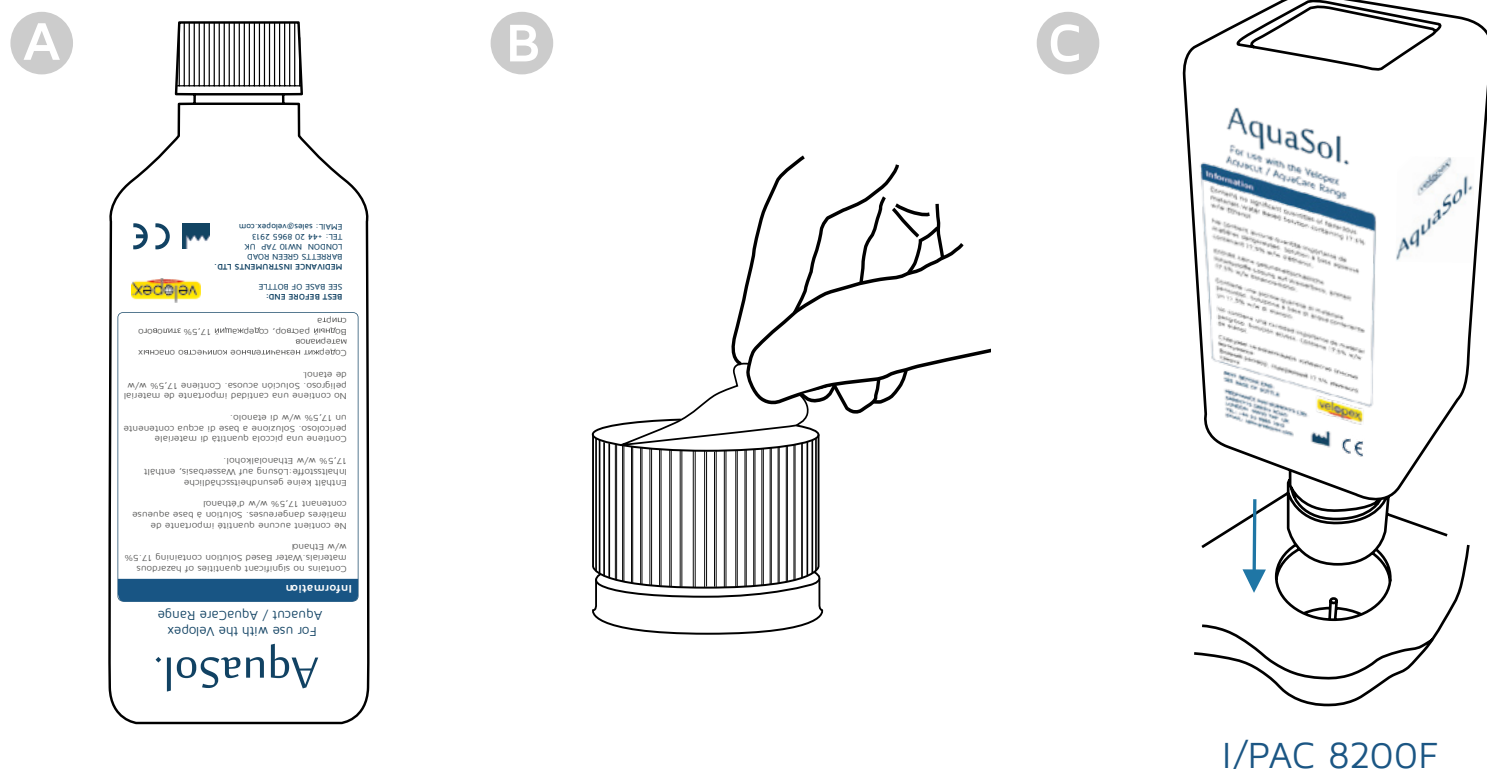

WARNING: The above fluid container is filled with a 17% alcohol solution. This acts as a biostatic solution in order to reduce biological growth within the fluid system. NOTE: Not for human consumption.

Should the AquaCare Twin unit be used with another solution obtained by the user, this must provide the required biostatic effect to ensure the machine's fluid system cannot sustain biological growth.

Failure to follow these guidelines could lead to user or patient contracting some sort of infection.

Assembling the handpiece

- See Parts and Features: Handpiece, Pg 12. Slide the handpiece handle onto the twin tube. This goes at the end of the tube without a check valve.
- Push the twin tubes firmly onto the nozzle tubes. The small twin tube pushes onto the small nozzle tube, and the large twin tube pushes onto the large nozzle tube. Make sure the twin tubes are securely in place.
- Slide the handle onto the handpiece until it is securely in place.
- Push the free end of the larger twin tube into the 'Powder Out' connector on the machine, see page 10 item 2.
- Push the free end of the smaller twin tube onto the 'Fluid Out' connector on the machine, see page 10 item 3.

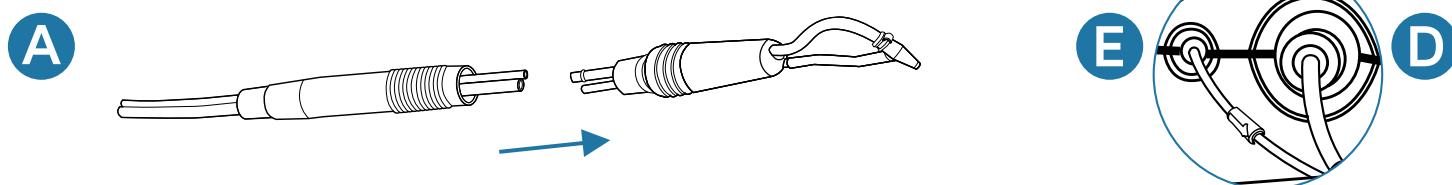

WARNING: The handpiece should be sterilised before use and after each subsequent use. See Maintenance: Sterilising the Handpiece, Pg 31.

Fitting the Disposable Feedline and Tip

- Take a new tip and fold over the locking tab as shown.
- Push the tip onto the nozzle until firmly engaged.
- Rotate the tip so that the free end points towards the handpiece.
- Push one end of the feedline onto the end of the handpiece.
- Push the other end of the feedline onto the tip.

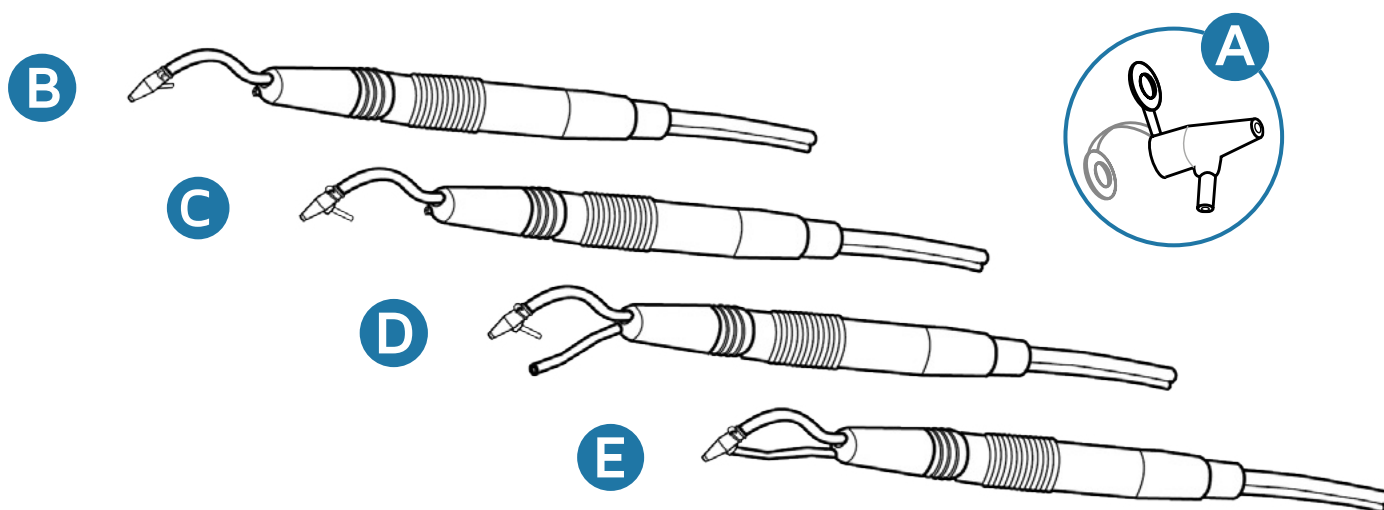

The tips and feedlines are for one time use only, a new tip and feedline should be used for each patient. To switch tips and feedlines remove the existing feedline tip and discard. Then follow the steps above. Purge the fluid through the system.

See Maintenance: Purging the AquaCare Pg 33.

Connecting the air supply

Air Supply Requirements

Clean dry air to ISO 8573 Class 1.4.1.

Pressure between 4 bar (72psi) and 7 bar (100psi).

Maximum flow rate +70 l/min. 4mm O/D input connection.

See **PARTS AND FEATURES: REAR VIEW OF AQUACARE, Pg 11.**

The practice's existing air supply system/compressor can be used provided it is fitted with a water removing filter and shut-off valve in the supply line.

Connect the blue air supply tube to the machine by pushing it fully into the blue connector.

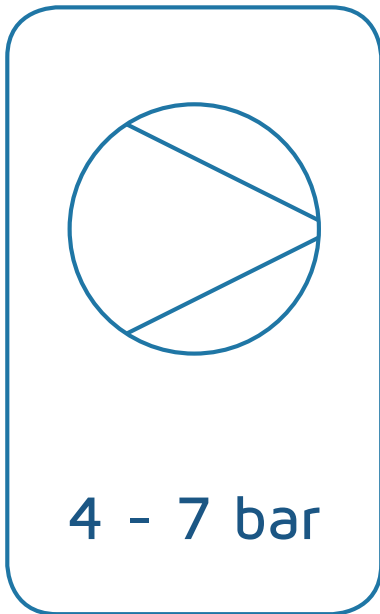

Air 

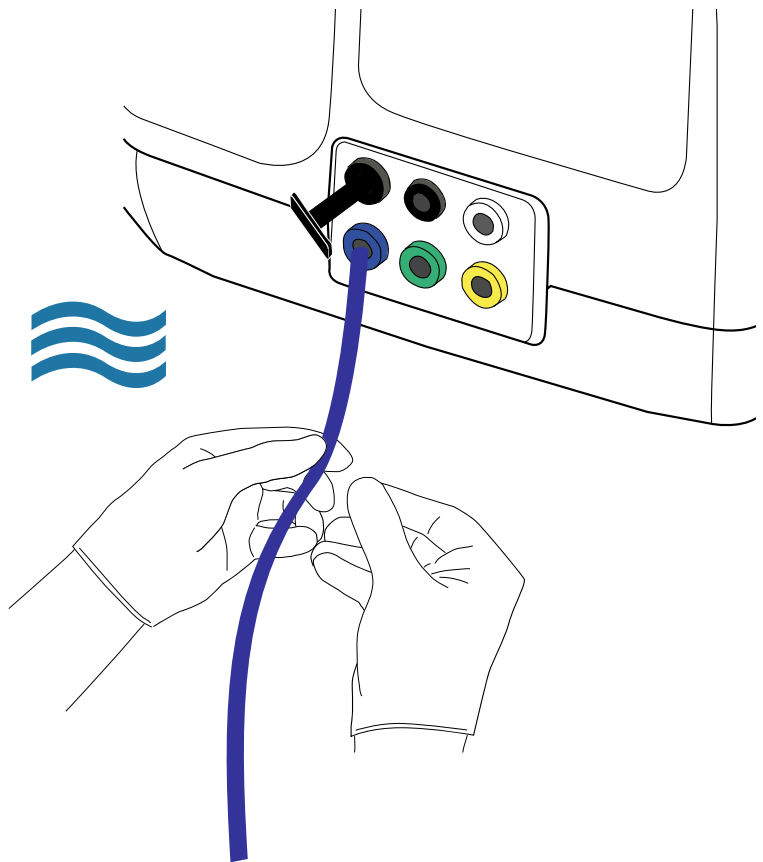

Installation Test

Before adding the powder to complete installation of the AquaCare Twin, you can check that the installation has been performed correctly using the following procedure:

- A. Check that the machine is off.
- B. Sterilise the handpiece. Refer to MAINTENANCE: STERILISING THE HANDPIECE, Pg 31.
- C. Fit the 0.6mm silver handpiece to the machine.
- D. Fit a new disposable feedline and tip.
- E. Check that the fluid container has been fitted.
- F. Make sure you are in full control of the handpiece before turning the machine on.
- G. Switch the On/Off selector to position On.
- H. Press the foot pedal down to the DRY position (1). (See PARTS AND FEATURES: FOOT PEDAL, Pg 11). Check that air comes out of the nozzle. There should be no fluid or powder.
- I. Press the foot pedal down to the WASH position (2). After a few seconds you should observe the flow of air change to a fine mist.
- J. Turn the Fluid volume dial, observing the spray. Place a paper towel under the nozzle at a distance of 25-30mm to make the effect easier to see. The Fluid volume range varies between:
 - DROPLET - Small quantity of water. Very fine mist.
 - SPRAY - Larger quantity of water. Heavier spray.
- K. Set the powder chamber selector to the prep position. Press the foot pedal fully down to the CUT position (3). You should hear the vibrator start to operate. Turn the media dial to set the gauge to the midway position. The nozzle will continue to spray a mixture of fluid and water, but no powder as this has not yet been installed. Then change the powder chamber selector to the prophy position and repeat the process to set the other media dial.
- L. Turn the Power dials, observing the Pressure gauges. The pressure ranges are:
 - 2 - Low energy, gentle cleaning/polishing action.
 - 4 - Medium energy, medium cutting action.
 - 6 - High energy, very fast cutting action.
- M. Switch the machine off.

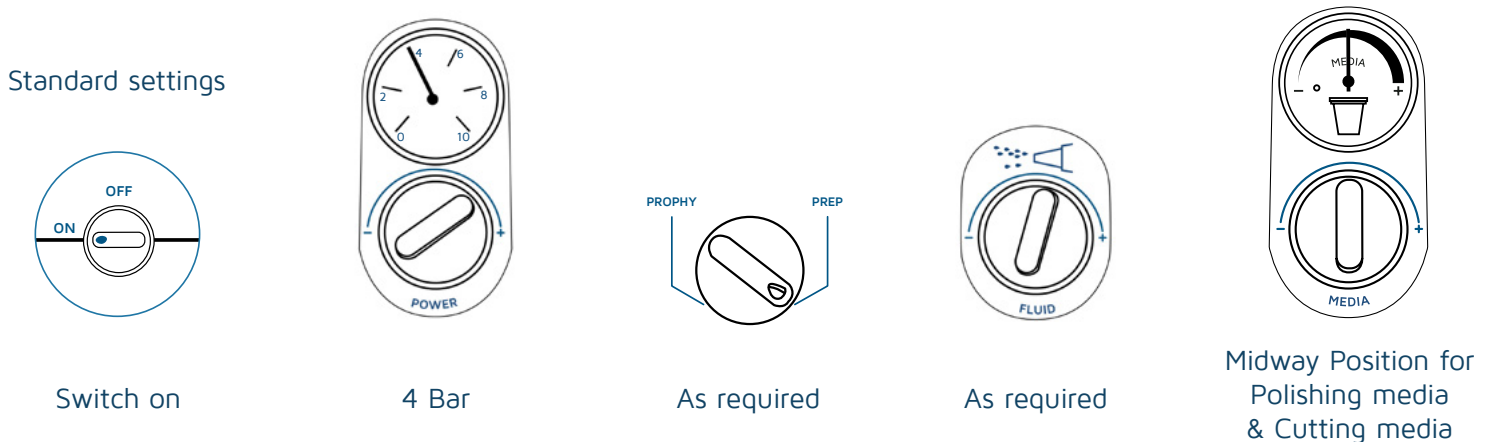

If your observations do not match the procedure above, check that all INSTALLATION sections have been completed correctly. If installation problems continue to occur, contact a Velopex Representative or Authorised Distributor for assistance.

Removing The Dosing Chamber Lids

- A. Ensure the unit is turned off and is fully depressurised. If the machine has been ON recently, allow 30 seconds for depressurising before attempting to remove the lid.
- B. Unscrew the required dosing chamber lid anti-clockwise 2/3 of a turn to relieve the pressure. Then unscrew a further turn and lift off.
- C. Shake the required Powder for 10-20 seconds.
- D. Pull out top yellow insert from the cartridge.
- E. Pull out the yellow lower draw tab on the cartridge.
- F. Line up the rib on the outside of the powder cartridge with the slot on the inside of the dosing chamber.
- G. Slide the powder cartridge down into the dosing chamber until it sits comfortably inside. If the cartridge sits unevenly or above the top of the dosing chamber, then lift it out and re-insert. Check that the rib of the powder cartridge slides down the slot in the dosing chamber - refit the dosing chamber lid.
- H. Close the dosing chamber by turning lid clockwise. Turn firmly until a strong resistance is felt from the seal engaging with the top of the chamber. Continue to turn the lid until you feel the lid tighten against a stop. **Always make sure the lid is fully closed before pressurising the machine.**
- I. To remove a powder cartridge, open the dosing chamber lid and gently lift the cartridge out of the machine. If the cartridge still contains some powder and will be used again, place the cartridge carefully into the powder storage pot supplied.

All powder cartridges supplied by Velopex are gamma irradiated. The contents are sterile until opened. Powder cartridges must not be refilled as the cartridges are not reusable.

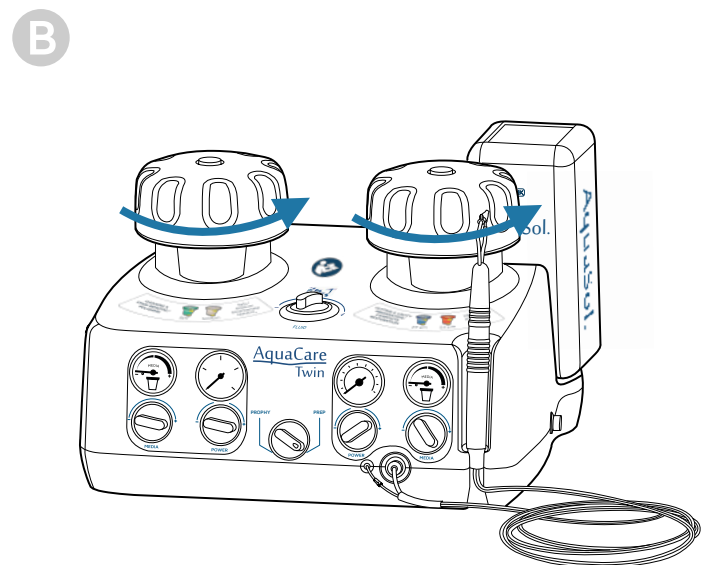
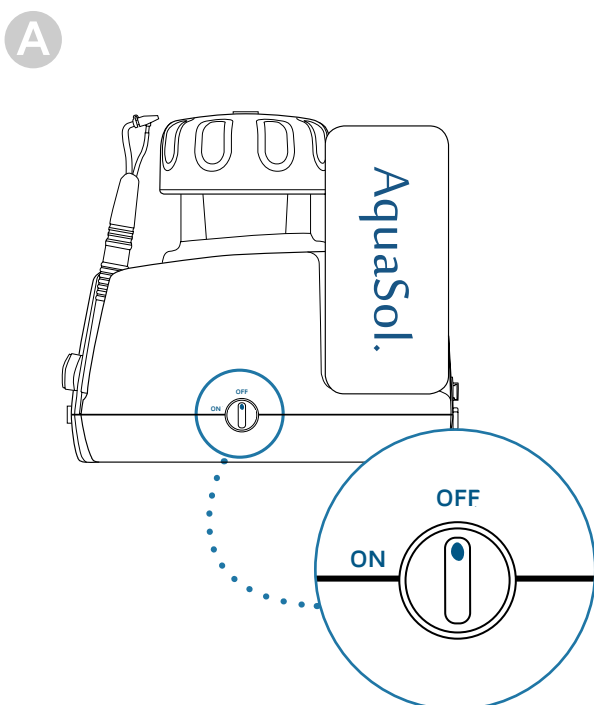

WAIT FOR DECOMPRESSION

Inserting The Powder Cartridges

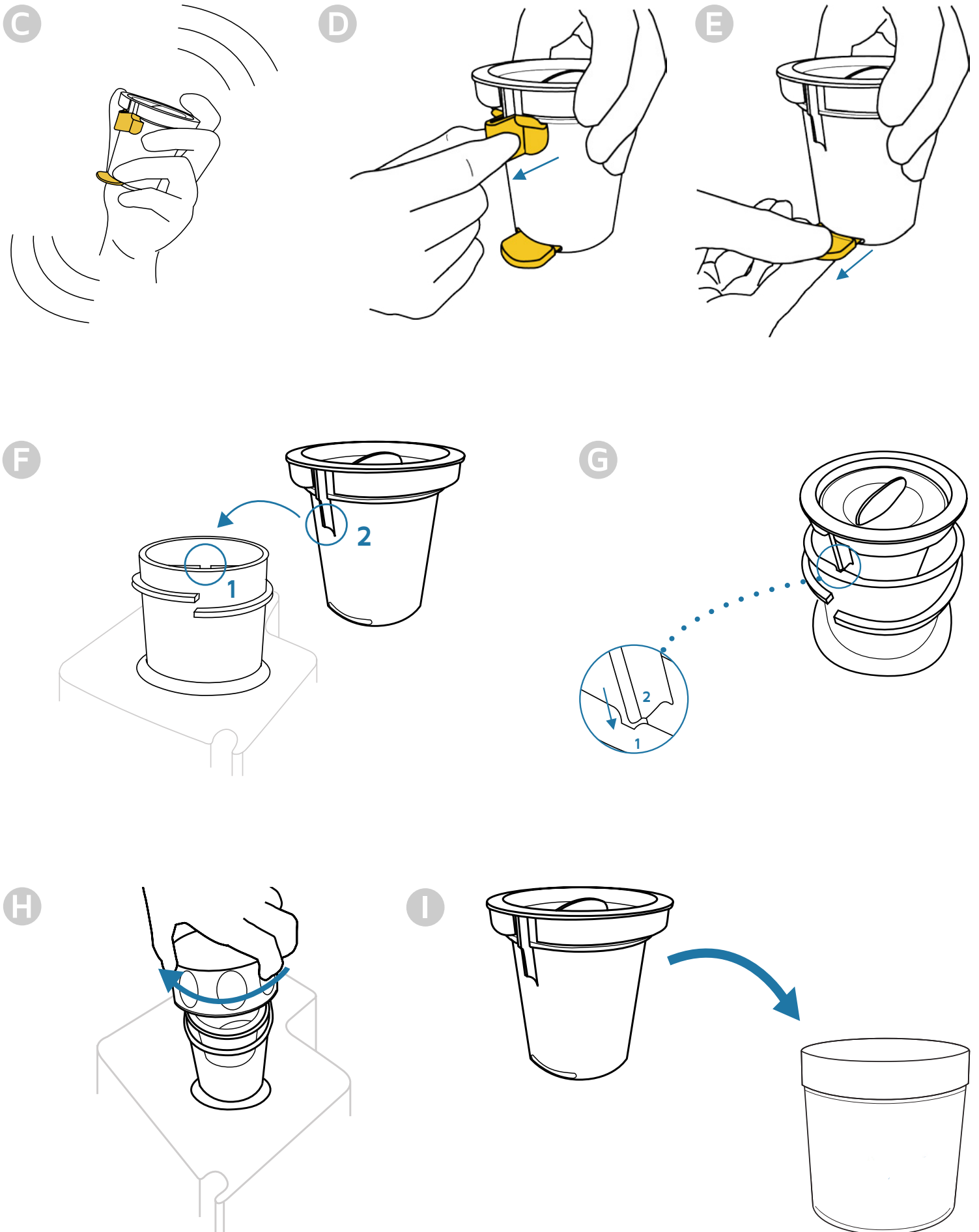

Preparing the AquaCare Twin For First Use

When training with the AquaCare Twin, powder could cause mess and damage to sensitive equipment if the user is not accustomed to operating the machine. For first use, either work near a sink or lay out a towel on the worksurface. Aim the handpiece nozzle into the inlet of your evacuation unit. Always wear goggles when operating the AquaCare Twin. See INTRODUCTION: SAFETY WARNINGS, Pg 5.

- A. Check that all of the INSTALLATION sections have been completed and the INSTALLATION TEST has been successful.
- B. Fit the left dosing chamber with a sodium bicarbonate powder cartridge (Prophy).
- C. Fit the right dosing chamber with either 29 or 53 micron Aluminium Oxide powder cartridge (Prep).
- D. Switch the powder chamber selector to left (Prophy) chamber.
- E. Make sure you are in full control of the handpiece.
- F. Switch the On/Off selector to ON position.
- G. Press the foot pedal fully down to the CUT position 3. You should hear the vibrator start to operate. The nozzle should start to spray a mixture of air, fluid and powder.
- H. Turn the Media volume dial, observing the spray. On a paper towel, you should see a ring of white powder inside an outer ring of fluid. The Media volume range as shown by the media gauge varies between:
 - Slightly under midway position - Low powder content, slow cutting/cleaning
 - Midway position - Medium powder content, cutting
 - Slightly above midway position - High powder content, very fast cutting
- I. Turn the powder chamber selector to the right (Prep) chamber to check that the other powder flows, then repeat step H to check the right media dial settings.
- J. The powder needs to be purged whenever you replace the powder cartridge. The fluid needs to be purged before first use and at the start of every day. See MAINTENANCE: PURGING THE AQUACARE, Pg 33.
- K. The AquaCare is now ready for use. Turn off the machine.

The OPERATION section contains training procedures to get started, and recommended settings for different uses.

If your observations do not match the results above, refer to the SERVICE section for a full test procedure and troubleshooting tips. Alternatively, refer the problem to a Velopex Representative or Authorised Distributor.

Use only original Velopex consumable products (powders, handpieces etc.). Other makes may damage the AquaCare or negatively alter performance.

First Steps To Mastering The AquaCare

CLEANING TRAINING WITH GLASS SLIDES

The glass microscope slides provided with your machine are similar in hardness to tooth enamel. Observing the effects of the settings on a glass slide gives a visual display of the speed of cleaning and polishing. Note: when using polishing powder, no marks will be made on the glass. Use a 0.6mm nozzle for these tests.

- A. Set up a suitable work area - a sink or a towel laid out on the worksurface.
- B. Ensure you are in full control of the handpiece and are aiming it in a safe direction.
- C. Insert Sodium Bicarbonate into the dosing left chamber.
- D. Turn the On/Off Selector to ON, set the powder selector to Prophy. (to set, press the foot pedal to position 3, set the dial then release the foot pedal).
- E. Set the media gauge to midway position.
- F. Set the power to 4 bar.
- G. Switch on the aspirator and hold the glass slide in front of its inlet tube.
- H. Aim the handpiece nozzle at the glass slide, 1.5mm from the surface, 30-45° from perpendicular.
- I. Press the foot pedal down to the 'CUT' position 3.
- J. Make light strokes across the slide as if the handpiece were a paintbrush.
- K. Observe how the powder rebounds from the surface of the slide. Practise moving the inlet of the aspirator with the handpiece to collect any waste powder efficiently.
- L. Move the foot pedal between polish, wash and dry positions to observe the results.
- M. Try using this technique to polish a drinks can. The paint will be removed with no damage to the metal underneath.

CUTTING TRAINING WITH GLASS SLIDES

These steps show how the AquaCare cuts through tooth enamel. Observing the effects on the slide show the size/shape of the various cutting techniques available.

- A. Follow steps A and B above.
- B. Insert some 29 micron aluminium oxide into the dosing chamber, turn machine 'On'.
- C. Set the media gauge to midway position (to set, press the foot pedal to position 3, set the dial then release the foot pedal).
- D. Set the power to 4 bar.
- E. Switch on the aspirator and hold the glass slide in front of its inlet tube.
- F. Aim the cutting tip at the glass slide, 1-2mm from the surface, 35-45° from perpendicular.
- G. Try making cuts of 2 seconds duration. Vary the angle and distance of the nozzle from the glass slide until the required results can be achieved predictably.
- H. Try varying the media volume, powder type, power, and fluid volume to explore the full range of cleaning and cutting possibilities.
- I. The next step is to use the above techniques to practise cleaning and cutting an extracted tooth. Experiment with the settings until you are confident you can achieve predictable, satisfactory results.

Suggested Treatment Methods

The following treatment suggestions have been prepared with the help of experienced practising dentists. The methods of treatment are advisory, and each dentist will quickly develop their own preferences in terms of power setting, powder type, media volume, fluid volume, and the angle of the cutting nozzle.

NOTE: The media volume dial (number 1 on page 10) can only be used to set the required volume when the footswitch is depressed to position 3.

TREATMENT TIPS

The end of the cutting nozzle should be held approximately 1.5mm from the working surface. Avoid holding the nozzle at a right angle to the surface, as this will cause the powder to rebound and blur the view of the area. Angle the cutting tip towards the aspirator and instruct the Dental Assistant to follow the nozzle with the aspirator.

The AquaCare operates with low noise, and has no vibration or heat at the cutting tip. Its ability to cut wet or dry gives it a high flexibility of use.

Local anaesthetic can be offered to nervous patients, however it is generally not required as fluid abrasion is painless in most cases.

The following treatments use a range of settings. Start at the lower end of the recommended settings and work up as you build proficiency.

The AquaCare Twin has three dynamic controls for each dosing chamber which alter the cutting speed/cleaning rate. These are the power setting, the media volume, and the fluid volume. By increasing one setting as you decrease another, you can maintain the same cutting speed/cleaning rate but alter the treatment provided. Use less media and more power to improve viewing of the working area. Use more media and less power for sensitive areas.

CLEANING ACCESSORY

The AquaCare Dental Air Abrasion Cabinet offers a simple aid in support of your AquaCare abrasion unit to enable abrasion procedures to be done outside of the mouth. Dental attachments such as crowns, bridges or brackets can be cleaned and abraded before they are cemented in the mouth. Pg. 39.

Preparations Before Treatment

WARNING: All people in the operating area must wear eye protection to BS EN 166 IF 415

WARNING: All people in the operating area except for the patient must wear respiratory masks to EN 149 FFP2S

1. It is recommended that a light coating of petroleum jelly is smeared around the patient's lips to prevent cracking and to retain some of the outflowing abrasive powder.
2. Rubber dam should be used to protect adjacent teeth and soft tissue.
3. Non-metal Matrix strips should be used to protect adjacent teeth during interproximal preparations.
4. A bib should be used to protect the patient's clothes from any out-flow of the material from the mouth during the course of a treatment.
- 5. Use a high-speed intra-oral aspirator, preferably with a flared tip.**
6. An extra-oral evacuator can also be used with the extraction cone sited below the patient's chin.
- 7. IMPORTANT: To avoid unnecessary damage, when switching from Aluminium Oxide to Sodium Bicarbonate you must purge the powder. See MAINTENANCE: PURGING THE AQUACARE, Pg 33.**
8. It is recommended that AquaCare Cleaning/Cutting Fluid (AquaSol) should be used in the AquaCare Fluid System. The 500ml bottle supplied with the machine should be discarded when empty and replaced. The fluid can be used with all recommended treatments using this instrument.

Please read INTRODUCTION: SAFETY WARNINGS, Pg 5-6 carefully before using the AquaCare Twin.

Treatments

CLEANING/STAIN REMOVAL

Settings:

Powder	- Sodium Bicarbonate (clear container) (left chamber).
Nozzle	- 0.6mm diameter or 0.8mm diameter.
Power	- 4 bar (left Power dial).
Media Flow	- Midway position (left Media dial).

This treatment is particularly easy when using the AquaCare Twin and gives a superior finish to the teeth. Where the teeth have been stained by coffee and/or smoking, fluid abrasion comes into its own.

The fine particles of sodium bicarbonate penetrate the micro crevices of the tooth surface and the particulate beam easily follows the contours of the tooth surface, enabling the staining to be removed very quickly and with no discomfort to the patient.

The settings as listed above will create a wide particulate beam of high velocity and medium particulate density. This is to prevent removal of the tooth enamel but provide sufficient power to remove staining.

The cutting nozzle should be held approximately 4mm from the surface of the tooth at an angle of approximately 45 degrees. By moving the nozzle further away from the surface of the tooth, the rate of removal of staining can be slowed down. Move the handpiece slowly over the tooth surface.

The most effective way to use fluid abrasion for this procedure is to use the handpiece of the AquaCare Twin as if it were a paintbrush, making light strokes across the surface of the tooth until the surface is clean. With experience, the dentist will be able to work with a high degree of control, the learning curve being similar to that when first using a high speed drill.

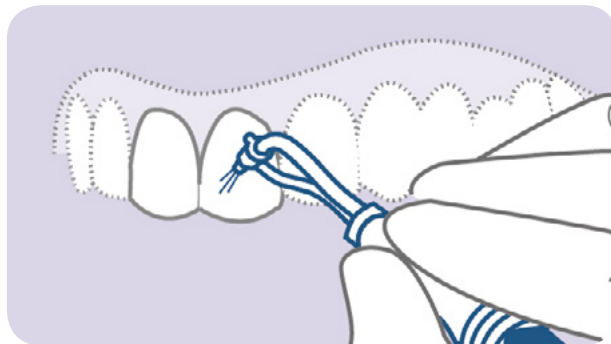

Angle 45°. Approx. 4mm
away from the surface.

Treatments

FISSURE CARIES TREATMENT

Settings:

Powder	- 29 micron Aluminium Oxide (blue container) (right chamber).
Nozzle	- 0.5mm diameter or 0.6mm diameter.
Power	- 4 bar (right Power dial).
Media Flow	- Slightly under midway position (right Media dial).

The AquaCare Twin is of particular use for treating fissure caries.

Hold the cutting nozzle about 2mm from the surface of the tooth and direct the particulate beam at the caries. Use it in short bursts, sweeping it along the vein until all the dark caries is removed and the sound tooth structure is revealed.

The beauty of the procedure is its speed and the absolute control possible, ensuring that the minimum amount of tooth structure is removed.

The newly prepared surface, being dry and abraded, is now ready for restorative materials. Normally local anaesthetic is not necessary for the above treatment.

NOTE: If there is soft caries present in the dentine, a rotary instrument may have to be used, or use the Sodium Bicarbonate on “cleaning” setting. This is because soft and moist caries are resilient and therefore not so effectively removed by the use of fluid abrasion.

NOTE: Stop the process periodically to check progress visually.



Approx. 2 mm
away from the surface.

Treatments

CAVITY PREPARATION

Settings:

Powder	- 53 micron Aluminium Oxide (red container) (right chamber).
Nozzle	- 0.6mm diameter or 0.8mm diameter.
Power	- 4-6 bar (right Power dial).
Powder Flow	- Slightly above midway position (right Media dial).

The procedure for the preparation of a cavity with the AquaCare Twin will depend on the size of the cavity and the extent and type of caries.

For small cavities, the cutting nozzle should be held at an angle of between 35 degrees and 45 degrees to the surface being abraded, and about 2mm or 3mm from the surface.

The best approach is to use a slow circular motion over the affected area until sound tooth structure is revealed. The tooth is now ready to be filled in the normal way.

For larger cavities, a combination of the AquaCare Twin and a rotary instrument may be of benefit. This is because fluid abrasion is a technique designed to produce a very conservative cut with a working area of less than 2mm diameter. Finally, the surface of the cavity should then be finished using the AquaCare Twin to ensure a suitable key for the bonding agent.

NOTE: Fluid abrasion is not a suitable technique for shaping undercuts for amalgam restorations. Traditional rotary instruments should be used for this application.



Angle 35-45°. Approx. 2-3 mm away from the surface.

Treatments

REMOVAL OF COMPOSITE RESTORATIONS

Settings:

Media	- 53 micron Aluminium Oxide (red container) (right chamber).
Nozzle	- 0.6mm diameter or 0.8mm diameter.
Power	- 4-6 bar (right Power dial).
Media Flow	- Slightly above midway position (right Media dial).

The AquaCare Twin is very useful for the removal of old composite restorations.

Hold the cutting nozzle at an angle of about 45 degrees to the surface of the old composite restoration and about 2mm or 3mm from the surface.

The best approach is to use a slow circular motion over the old restoration beginning at the edge, particularly at the failed margin, until all the old composite has been removed and the cavity preparation completed.

The new restorative can now be applied in the normal manner without any further treatment. Follow the manufacturer's recommendations with regard to the use of acid etch with bonding systems.



Angle 45°. Approx. 2-3 mm
away from the surface.

Treatments

BONDING ORTHODONTIC BRACKETS

Settings:

Media	- 29/53 micron Aluminium Oxide (blue/red container) (right chamber).
Nozzle	- 0.6mm diameter or 0.8mm diameter.
Power	- 4 bar (right Power dial).
Media Flow	- Slightly under midway position (right Media dial).

The enamel of the tooth to be treated can be “etched” to the exact size of the orthodontic bracket at the place of attachment.

This is achieved by holding the cutting nozzle 2mm above the surface of the tooth and gently moving it in a circular motion over the required area. This will result in a dry “etched” surface, ready to accept the bonding agent, and the risk of saliva contamination is greatly reduced because the aluminium oxide dries the surrounding mucosa.

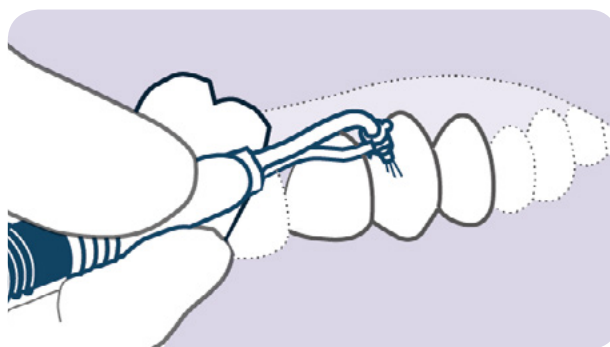

Approx. 2 mm
away from the surface.

Sterilising The Handpiece

The handpiece is supplied clean, but not sterile. **The handpiece should be sterilised before first use, and between all subsequent uses. Do not use an ultra-sonic washer.**

- A. Remove and discard the disposable feedline and tip (See INSTALLATION: FITTING THE DISPOSABLE FEEDLINE AND TIP, Pg 17).
- B. Disassemble the handpiece parts (See PARTS AND FEATURES: HANDPIECE, Pg 12). For safety, treat used handpiece equipment as if it is contaminated with infectious material. Wash all of the parts thoroughly in mild soapy water, removing any debris or blockages.
- C. Alternatively, place handpiece parts in automatic washer/disinfector baskets following the manufacturer's recommendations. Wash in a slightly alkaline or neutral pH detergent, as recommended by the manufacturer of the machine.
- D. When cleaning is completed the handpiece must be sterilised. To steam sterilise/autoclave the handpiece effectively, the two channels through the handpiece must be clear and unblocked.
- E. Check the flow from the nozzles. If the channels are blocked, use the cleaning wire to clear them, then rewash as detailed in B or C.

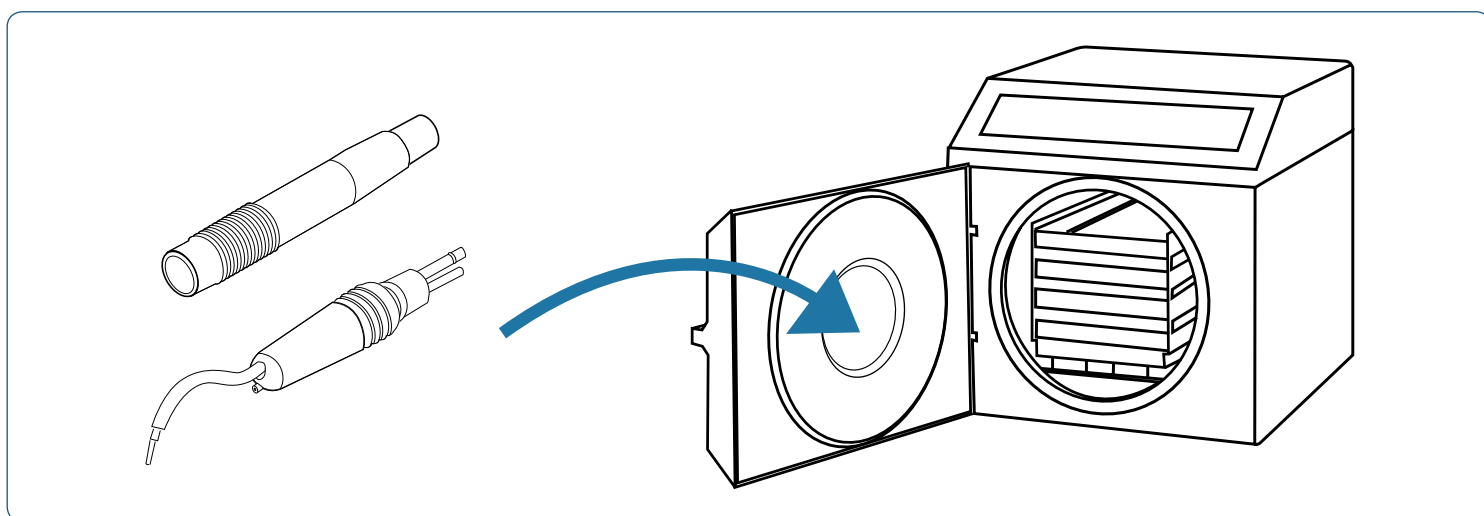

- F. Place the handpiece in a steam steriliser/autoclave. The handpiece must be sterilised to a minimum of 134°C at 2 bar for 3.5 minutes. This will ensure a Sterility Assurance Level (SAL) of 1×10^{-6} . Dry for a minimum of 3 minutes using vacuum drying.
- G. A suitable sterilisation pouch should be used to maintain sterility. The plastic parts should be replaced after 20 cycles. The handpiece should be replaced when cutting efficiency is impaired.

This cleaning and sterilising procedure satisfies UK Health Technical Memorandum 2030 Washers-Disinfectors and UK Health Technical Memorandum 2010 Sterilisation.

Handpiece Maintenance

Blockages

If the abrasive powder ceases to flow from the nozzle while cutting is in progress, the nozzle may have become blocked with abrasive particles. Turn off and depressurise the machine. Now remove the handpiece and clear the blockage by inserting a length of 0.35mm wire (supplied) through the nozzle from the tip.

Inspection

Regularly inspect the cutting nozzle and handpiece for excessive wear or damage. Do not use a Handpiece if the hole in the tip of the nozzle is worn to the outer edge or if the abrasive perforates the swan neck tube.

The life expectancy in normal use is approx 6 months. Using the AquaCare Twin at its higher power and media setting will lead to higher wear rates on the handpiece.

The handpiece is a consumable, see page 39.

Twin Tube Assembly Maintenance

Cleaning

The Twin Tube Assembly must not be autoclaved. Wash the Twin Tube Assembly in mild soapy water and rinse thoroughly. Allow to dry completely before use. Always purge the tubes with Powder and Fluid thoroughly before use.

Inspection

Ensure the Twin Tubes are in good condition and fit together correctly with the Handpiece. Test the Check Valve is functioning. The valve prevents fluid being forced back down the tube during use.

Check 1 - With the twin tube filled with fluid, disconnect the tube at the Fluid Out connection, (page 10, item 3). Hold the handpiece up vertically and check that the fluid in the tube does not drip from the disconnected end. Reconnect the tube.

Check 2 - With the machine in the 'ready to use' condition, press the 'Wash' control on the foot pedal and gently press the plastic tip on the end of the nozzle down onto a flat surface (e.g. a glass slide). The fluid should be prevented from blowing back down the fluid line past the handpiece. The joint between the plastic tip and feedline may also disconnect.

Replace the whole check valve assembly if any faults are found. The twin tube assembly should be replaced annually.

Purging The AquaCare

PURGING THE FLUID

When replacing the fluid bottle, the machine will need to be purged of any air that may have entered the system.

- A. Turn the media setting to minimum position. This will prevent unnecessary powder being expelled from the handpiece.
- B. Point the handpiece in a safe direction (e.g. the inlet of the evacuation unit).
- C. Press the foot pedal to position 2 (wash) for at least 10 seconds.
- D. The machine will expel air from the handpiece and purge the fluid through the line.
- E. The procedure is complete when a continuous fine mist sprays from the nozzle and no air pockets can be seen in the smaller tube.
- F. Reset the media volume as desired (note that the footswitch will need to be depressed to position 3 to reset the media gauge).

We recommend that the fluid bottle is checked prior to surgery to ensure it will not run out whilst working. Replace the container if the level is low prior to surgery.

Always purge the fluid for 20 seconds before initial use and at the start of every day.

PURGING THE POWDER

This will empty the feed tube and handpiece of any previous powder and charge them with the new powder.

- A. Hold the handpiece and direct the nozzle into the inlet of the evacuation unit.
- B. Press the foot pedal to position 3 (cut) for at least 10 seconds.
- C. Observe the flow of abrasive powder as it is emitted from the nozzle.
- D. The procedure is complete when the flow of powder is uniform.

This charges the feed tube and handpiece with the new abrasive powder and flushes out any previous powder. We recommend that this procedure is carried out every time the powder is changed.

Cleaning The AquaCare Twin

Wipe the casing, the dosing chambers, and their lids clean with a damp cloth, ensuring no liquid gets inside the machine. The inside of the dosing chambers, lids and the powder cartridges must be kept dry at all times.

WARNING: under no circumstances must any other cleaning agent, including surface wipes containing alcohol, come into contact with the case or the dosing chambers.

The Dosing Chambers and Dosing Chamber Lids are made of special materials and are repeatedly pressurised. They should be checked for any visible damage whenever the powder is changed. If there is any damage visible, do not use the AquaCare unit until it has been inspected by a Velopex Representative or Authorised Distributor.

The rear water socket needs to be checked on a regular basis to ensure that there is no build-up of dust/powder or mould growth within the socket.

Use a cotton bud soaked with AquaSol to clean the socket of any growths. If the socket has accumulated powder/dust, use the AquaCare (position 1, Air, on the foot pedal) to blow out the socket as required.

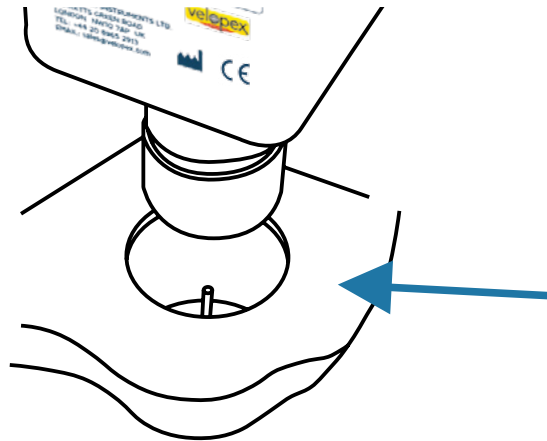

Troubleshooting

If you are having problems with your AquaCare Twin, please follow the steps below before proceeding further as these will often resolve general faults.

1. Ensure that the compressed air supply is at the specified pressure, connected and on.
2. Ensure that the unit is switched on.
3. Check that none of the controls are set to minimum.
4. Check that the colour coded foot pedal hoses have been correctly connected to their matching terminals on the back of the machine.
5. Check the fluid bottle is at least 50% full.
6. Ensure the dosing chambers are correctly loaded with the required powder pot, and that the powder pot contains an ample level of powder.
7. Check the Dosing Chamber Lid is screwed on securely and correctly.
8. Check that there is no water or wet air contaminating the pneumatic system. This can occur if the compressed air source is not filtered effectively enough. If this is the case, contact a Velopex Representative or Authorised Dealer who will be able to assess the damage to the AquaCare unit.

Symptom

No air flow through the nozzle.

Action

1. Ensure that the power dial is turned up to at least "2". This should give a detectable airflow.
2. Check that the nozzle is not blocked. If blocked remove the handpiece and clear the blockage with a cleaning wire - I/FIT 8073F.
3. Ensure the twin tube is straight and has no kinks or folds.
4. If the Internal Filters have not been changed over the last 12 months, they can become soiled, blocking the air line. See ANNUAL SERVICE: REPLACING THE AIR FILTER, Pg 38.
5. If the Powder Pinch Tube is split it will not operate, preventing air from flowing to the nozzle. This will need to be resolved by replacing the part. See ANNUAL SERVICE: REPLACING THE POWDER PINCH TUBE, Pg 38.

Troubleshooting

Symptom

No powder flow through the nozzle when the foot pedal is pressed down to the "CUT" position.

Action

1. Check that you have fitted the Powder Cartridges into the Dosing Chambers. Make sure that the Powder Cartridges are not empty.
2. Turn the Media Volume control up to maximum.
3. Check that there are no objects blocking the foot pedal from moving normally.
4. Depressurise the machine. Remove the Dosing Chamber Lids and look inside them. In the centre of each lid you should see a star seal. This should be flat in the lid: if not, remove and refit, replace if required.
5. Press the foot pedal down to the DRY or WASH position, no. 1 or 2. You should hear the noise of air flowing through the machine. Now press the foot pedal down to the CUT position, no. 3. You should hear the noise increase as the vibrator starts to operate. If you do not hear an increase in noise, then the vibrator may be faulty. Please contact a Velopex Representative or Authorised Distributor for further help.

Symptom

Irregular flow or no flow of cutting fluid to the tip.

Action

1. Check that the fluid volume control is not set to minimum. Rotate clockwise to increase fluid volume.
2. Change the feedline and tip. In most cases the plastic tip should last long enough for an individual patient treatment. However, prolonged treatment or failure to change feedline and tip between treatments will wear the feedline and tip, causing reduced or uncontrolled flow. See INSTALLATION: FITTING THE DISPOSABLE FEEDLINE AND TIP, Pg 17.
3. Ensure the plastic tip is firmly engaged on the cutting nozzle.
4. Check the fluid bottle is filled to at least 50%.
5. The check valve (page 12, Item 31) could be blocked or stuck. Disconnect the fluid connection and purge the line. This should unblock the valve. If this is not effective, replace the check valve.
6. Check for a blockage in the supply line. Look at the clear twin tube for any material blocking the tube.
7. If there are also air bubbles in the fluid tube this can indicate a leaking joint. Look along the tube to see where the air bubbles are appearing to find the source of the leak. Check the joint and replace if necessary.

Troubleshooting

Symptom

Audible air leak and fall in performance.

Action

Ensure that the dosing chamber lids are tightly closed. If a dosing chamber lid is loose or not correctly sealed, a large amount of air will leak from the machine. Turn the unit off and carefully wipe the inner Lid seal and Dosing Chamber sealing faces. Screw the lid on tightly until it has reached the end of its thread.

NOTE: If the fault cannot be located and repaired by referring to this troubleshooting guide it will be necessary to acquire the services of a Velopex representative or authorised dealer for a more thorough diagnosis and service of the unit.

Annual service and safety check

In order to ensure that the AquaCare Twin continues to function safely and reliably, it is important that you contact your Velopex supplier to book an annual service and safety check every 12 months.

If during use there is a problem that could not be rectified after following the troubleshooting checks (as detailed on pages 35-37), then a service will be required to rectify the fault.

The following elements will be addressed during the annual service.

- A. Replacing the air filters every 12 months.
- B. Replacing the powder pinch tubes every 12 months.
- C. Replacing the powder pinch tube members every 12 months.
- D. Dosing chambers - inspection required - replaced every 24 months.
- E. Dosing chamber lids - inspection required - replaced every 24 months.

NOTE: On previous machines in the range, some of these tasks could have been performed by the end user, however the latest MK5 design does not allow access to the machine and therefore must be performed via Velopex support.

Recommended Accessories

Description

Equipment

	Part No
Breathing air filter unit	I/FIT 8200F
6mm Hose	I/ROL 8014F
4mm Hose	I/ROL 8006F
6mm to 4mm Converter (Input Air Hose)	I/FIT 8290F
AquaCare Stand (Patient Treatment Centre)	I/ASS 0045F
Velopex Dental Air Abrasion Cabinet	I/MAC 6200F

Consumables

Sylc Bioactive Powder Cartridges, Pack of 4	I/PDR 0034F
Sodium Bicarbonate Cartridges, Pack of 4	I/PDR 8014F
29 micron Aluminium Oxide Cartridges, Pack of 4	I/PDR 8025F
53 micron Aluminium Oxide Cartridges, Pack of 4	I/PDR 8024F
Glass Slides (for cutting practice), Pack of 5	I/MIC 0010F
Feedlines and Tips, Pack of 50	I/ASS 8007F
Handpiece Handles, Pack of 5	I/ASS 8024F
Handpiece Tube Removal Tool	I/FIT 0025F
Handpiece - 0.4mm Green	I/ASS 8189F
Handpiece - 0.6mm Silver	I/ASS 8191F
Handpiece - 0.8mm Gold	I/ASS 8192F
500 ml Cutting Fluid (AquaSol)	I/PAC 8200F
Nozzle Cleaning Wire	I/FIT 8073F

WARNING: All replacement parts and consumables must be sourced from Velopex to ensure correct and safe functioning of the AquaCare.

Spare Parts

Storage Tank and Lid	I/ASS 8193F
Dosing Chamber Lid	I/ASS 8003F
Powder Storage Pot	I/ASS 8197F
Twin Tube (with check valve)	I/ASS 8020F
Check Valve, Pack of 2	I/ASS 8004F
Foot Pedal Assembly	I/FIT 8153F
Dosing Chamber Starfish Seal	I/FIT 0012F

Notes

Notes

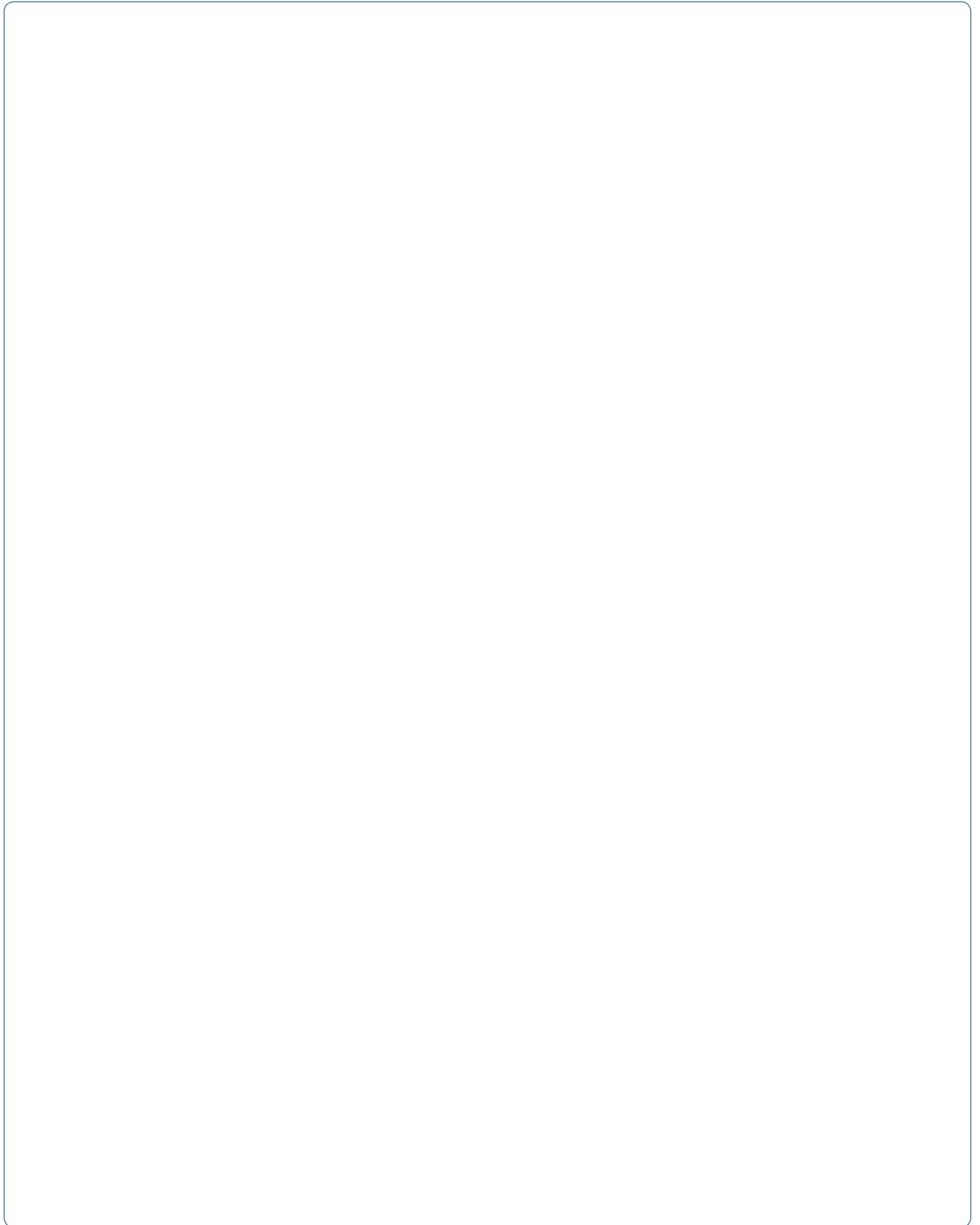

Notes

Notes

AquaCare Twin

AT10,0000

ENGLISH

Dental Air Abrasion & Polishing Unit

Installation & Operation Maintenance Manual

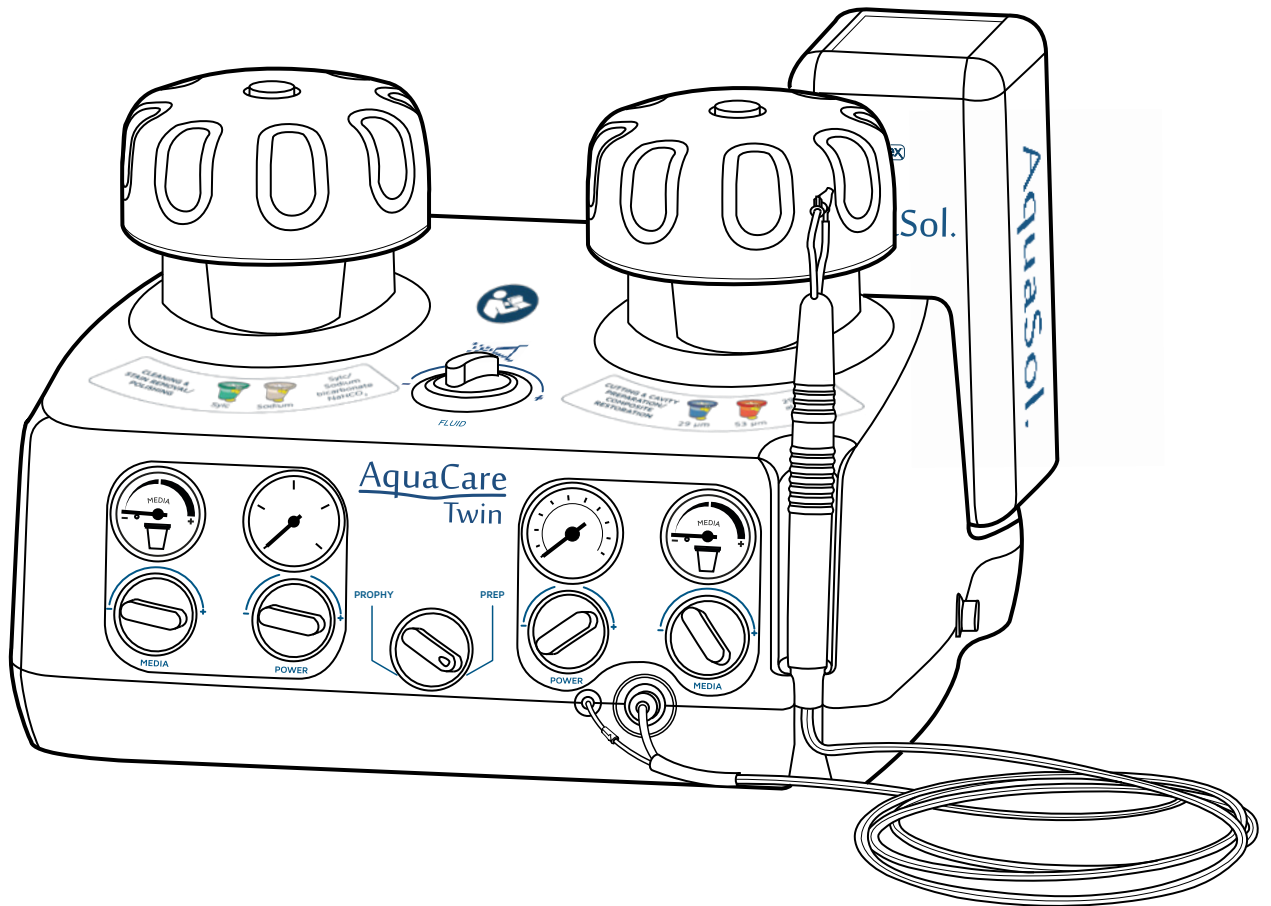

www.velopex.com



MEDIVANCE INSTRUMENTS LTD. • Barretts Green Road • Harlesden • London • NW10 7AP



FDA 9051184

CE 0120

AquaCare Twin
User Manual Iss. 3
I/LIT0141 Issued 01/2016