

CHIROPRO 3rd Gen

ENG INSTRUCTIONS FOR USE.



Set Chiropro 3rd Gen REF 1700708-001



REF 1600995-001



REF 1303393-001



REF 1601008-001

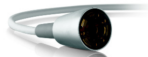

REF 1601009-001



REF 1600631-001



REF 1500984-005



REF 1307727-010



REF 1301575-001



REF 1502329-001

Set Chiropro 3rd Gen CA REF 1700707-001



REF 1700708-001



REF 1303393-001



REF 1601008-001



REF 1601009-001



REF 1600631-001



REF 1600692-001

Set Chiropro 3rd Gen KM REF 1700737-001



REF 1600995-001



REF 1303393-001



REF 1601008-001

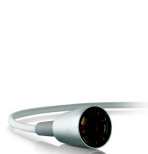

REF 1601009-001



REF 1600631-001

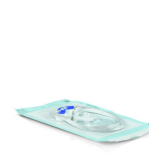

REF 1501635-010



REF 1307727-010



REF 1301575-001



REF 1502329-001

Set Chiropro 3rd Gen KM CA REF 1700736-001



REF 1700737-001



REF 1303393-001



REF 1601008-001



REF 1601009-001



REF 1600631-001



REF 1600786-001

Options



REF 1601008-001



REF 1600692-001



REF 1600598-001



REF 1600785-001



REF 1600786-001



REF 1600052-001



REF 1303393-001



REF 1601009-001



REF 1600631-001



REF 1301575-001



REF 1502329-001



REF 1307727-010



REF 1307312-010



REF 1500984-010



REF 1501738-010



REF 1501635-010



REF 1501621-010



















REF 1307031-001

Table of contents













1	Symbols.....	2
1.1	Description of symbols for Chiropro 3 rd Gen units	2
1.2	Description of symbols for Chiropro 3 rd Gen accessories	2
2	Identification, Intended Use and Notation... 3	
2.1	Identification	3
2.2	Intended use	3
2.3	Notation and chapter links	3
3	Warnings & Precautions of Use	4
4	Description.....	5
4.1	Chiropro 3 rd Gen system overview	5
4.2	Sets supplied.....	6
4.3	Options	6
4.4	Technical data	6
4.5	Environmental protection and information for disposal.....	7
4.6	Electromagnetic compatibility (technical description)	7
4.6.1	Precautions of use	7
4.6.2	Electromagnetic compatibility warnings	7
4.6.3	Electromagnetic compatibility – emissions & immunity	8
5	Installation	10
5.1	Install the Chiropro 3 rd Gen system	11
5.2	On/off procedure.....	11
6	Interface overview.....	12
6.1	Chiropro 3 rd Gen modes.....	12
6.2	Rotating knob functions overview.....	12
6.3	Sound alerts	13
7	Operation.....	14
7.1	Operation screen description	14
7.2	Perform an operation, steps P1 and P2.....	14
7.3	Perform an operation, steps P3, P4 and P5.....	14
8	Settings	16
8.1	MX-i LED 3 rd Gen micromotor speed	16
8.2	MX-i LED 3 rd Gen micromotor torque	16
8.3	MX-i LED 3 rd Gen micromotor rotation direction.....	16
8.4	Irrigation level.....	17
8.5	Contra-angle ratio.....	17
9	Special modes.....	18
10	List of errors & Troubleshooting	20
10.1	Safety warning (operating).....	20
10.2	Device operating error.....	21
11	Maintenance	22
11.1	Serviceing.....	22
11.2	Cleaning & disinfection.....	22
11.3	Important.....	22
11.4	Replacement of fuses.....	23
12	General information and guarantee.....	24
12.1	General information	24
12.2	Terms of guarantee	24

1 Symbols

1.1 Description of symbols for Chiropro 3rd Gen units

Symbol	Description	Symbol	Description
	CE Marking with number of the notified body.		Recyclable materials.
	Main switch - Power OFF.		Separate collection of electric and electronic equipment.
	Main switch - Power ON.		Manufacturer.
	Fuse Ø 5 x 20 mm.		Light.
	Alternating current.		Sound alerts.
	RF emitting device (Interference may occur in the vicinity of equipment marked with this symbol).		Warning: in accordance with federal law (USA), this device is only available for sale upon recommendation by an accredited practitioner.
	CAUTION! Consult accompanying documents. Provides an instruction that should be observed for safety reasons.		CSA marking - Complies with U.S. and Canadian standards.
	Refer to the accompanying documents (www.bienair.com/ifu).		Serial number.
	Reference number.		

1.2 Description of symbols for Chiropro 3rd Gen accessories

Symbol	Description	Symbol	Description
	CE Marking with number of the notified body.		Machine washable.
	Expiration date.		Recyclable materials.
	Product containing phthalates.		Separate collection of electric and electronic equipment.
	Do not reuse.		Sterilizable in autoclave up to the specified temperature.
	Sterilized with Ethylene Oxide.		Manufacturer.
	Electrical safety. Applied part type B.		Serial number.
	Reference number.		

2 Identification, Intended Use and Notation

2.1 Identification

Electronically controlled tabletop device for dentistry allowing operation of a dental handpiece via an MX-i LED 3rd Gen micromotor with variable speed control by a pedal.

A peristaltic pump conveys the physiological liquid via a disposable irrigation line without being contaminated.

The device's LCD display indicates and allows to control operation settings.

2.2 Intended use

The equipment is to be used by dentists and surgeons in dental offices and hospitals. The system is designed to control a dental MX-i LED 3rd Gen micromotor only which can drive a dental handpiece fitted with appropriate tools to cut hard and soft tissues in the oral cavity and to place dental implants.

The system is intended for use in dentistry for implantology.

Any use other than that for which this product is intended is unauthorized and may be dangerous.

The system meets all the current legal requirements for medical devices.

Chiropro 3rd Gen dental unit is intended for use in dental implantology.

The intended electromagnetic environment (per IEC 60601-1-2 ed. 4.0) is Professional healthcare facility environment.

2.3 Notation and chapter links

- **A, B, C**, etc.
Text preceded by a letter indicates a procedure to be carried out step-by-step.
- 
Indicates a procedure result.
- **(1), (2), (3)**, etc.
Text preceded by a number indicates text used in conjunction with an illustration.
- ***OK, Settings***, etc.
Text in bold italic font style indicates, on-screen elements such as buttons, menus, menu items, screen areas, values, fields when they are named and screen names.

In order to simplify the notation, in this manual:

- «Clockwise» is referred to as «CW»;
- «Counterclockwise» is referred to as «CCW»;
- Forward micromotor rotation mode is referred to as «FWD»;
- Reverse micromotor rotation mode is referred to as «REV»;
- Rotational speed unit «revolutions per minute» is referred to as «rpm»;
- Torque unit «newton centimetre» is referred to as «Ncm»;
- Micromotor control unit is referred to as «DMX».

3 Warnings & Precautions of Use

⚠ CAUTION

The power plug is used for disconnection in case of problems, it must be easily accessible at all times.

⚠ CAUTION

Never connect a handpiece on a running MX-i LED 3rd Gen micromotor.

⚠ CAUTION

Any modification of the medical device is strictly forbidden.

⚠ CAUTION

The device is not designed for use in an explosive atmosphere (anaesthetic gas).

⚠ CAUTION

Do not attempt to open the device when it is connected to the electric mains.
Risk of electrocution.

⚠ CAUTION

The parameters contained in the dental procedures are indicative only. Bien-Air Dental SA cannot be held liable for them.

⚠ CAUTION

The device must not be touched by the patient.

⚠ CAUTION

Do not simultaneously touch the patient and the pump or contacts of connectors.

⚠ CAUTION

Ensure that there is no water under the unit before switching it on.

⚠ CAUTION

All connectors must be dry before use. Ensure the absence of residual moisture due to cleaning.

⚠ WARNING

To avoid the risk of electric shock, this equipment must only be connected to a supply mains with protective earth.

4 Description

4.1 Chiropro 3rd Gen system overview

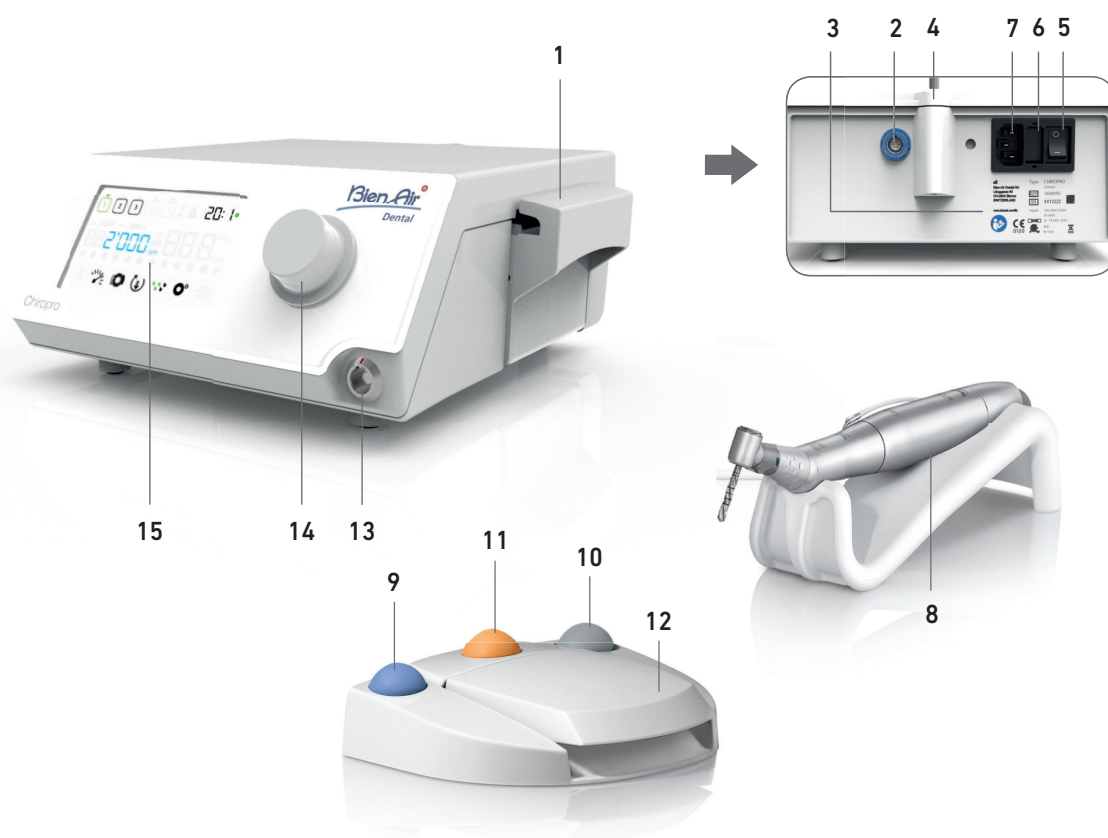

FIG. 1

- | | |
|---|--|
| (1) Peristaltic pump lid | (9) Button to start/stop irrigation |
| (2) Pedal connector | (10) Foot control to reverse the rotation of the MX-i LED 3 rd Gen micromotor |
| (3) Marking | (11) "Program" button to go to next operation step |
| (4) Bracket support | (12) Motor start |
| (5) Main switch | (13) MX-i LED 3 rd Gen micromotor connector |
| (6) Fuse box | (14) Control knob |
| (7) Mains connector | (15) LCD control screen |
| (8) MX-i LED 3 rd Gen micromotor | |

4.2 Sets supplied

Chiropro 3rd Gen set REF 1700708-001

Designation	REF number
Chiropro 3 rd Gen unit (1x)	1600995-001
MX-i LED 3 rd Gen micromotor (1x)	1601008-001
3-button pedal (1x)	1600631-001
Cable MX-i LED 3 rd Gen (2m) (1x)	1601009-001
Sterile protective sheet (2x)	1502329-001
Pack of 5 disposable sterile irrigation lines	1500984-005
Pack of 10 attachment collars for fastening the sterile irrigation line to a cable	1307727-010
Bracket for fluid bottle (1x)	1303393-001
Handpiece support (1x)	1301575-001
3P cable system, US/Asia, length 2m (1x)	1300067-001
3P cable system, Europe, length 2.5 m (1x)	1300066-001
3P cable system, Switzerland, length 2 m (1x)	1300065-001

Chiropro 3rd Gen CA set REF 1700707-001

Designation	REF number
Chiropro 3 rd Gen set (1x)	1700708-001
Contra-angle handpiece CA 20:1 L Micro-Series (light) (1x)	1600692-001

Chiropro 3rd Gen KM set REF 1700737-001

Designation	REF number
Chiropro 3 rd Gen unit (1x)	1600995-001
MX-i LED 3 rd Gen micromotor (1x)	1601008-001
3-button pedal (1x)	1600631-001
Cable MX-i LED 3 rd Gen (2m) (1x)	1601009-001
Sterile protective sheet (2x)	1502329-001
Kirschner/Meyer pack of 10 disposable sterile lines	1501635-010
Pack of 10 attachment collars for fastening the sterile irrigation line to a cable	1307727-010
Bracket for fluid bottle (1x)	1303393-001
Handpiece support (1x)	1301575-001
3P cable system, US/Asia, length 2m (1x)	1300067-001
3P cable system, Europe, length 2.5 m (1x)	1300066-001
3P cable system, Switzerland, length 2 m (1x)	1300065-001

Chiropro 3rd Gen KM CA set REF 1700736-001

Designation	REF number
Chiropro 3 rd Gen KM set (1x)	1700737-001
Contra-angle handpiece CA 20:1 L KM Micro-Series (light)	1600786-001

4.3 Options

Designation	REF number
3-button pedal	1600631-001
MX-i LED 3 rd Gen micromotor	1601008-001
Contra-angle handpiece CA 20:1 L KM Micro-Series (light)	1600786-001
Contra-angle handpiece CA 20:1 L KM (light)	1600785-001
Contra-angle handpiece CA 20:1 L Micro-Series (light)	1600692-001
Contra-angle handpiece CA 20:1 L (light)	1600598-001
Straight handpiece PM 1:1 Micro-Series	1600052-001
Sterile protective sheet	1502329-001
Pack of 10 disposable sterile lines 3.5 m	1501738-010
Kirschner/Meyer pack of 10 disposable sterile lines	1501635-010
Kirschner/Meyer type detachable irrigation set for CA 20:1 L KM and CA 20:1 L KM Micro-Series, comprising 10 rings and 10 tubes	1501621-010
Pack of 10 disposable sterile lines	1500984-010
Bracket for fluid bottle	1303393-001
Handpiece support	1301575-001
Cable MX-i LED 3 rd Gen (2m)	1601009-001
3P cable system, US/Asia, length 2m	1300067-001
3P cable system, Europe, length 2.5 m	1300066-001
3P cable system, Switzerland, length 2 m	1300065-001
Pack of 10 attachments collars for fastening the sterile irrigation line to a cable	1307727-010
Pack of 10 fuses T4.0AH 250 VAC high breaking capacity	1307312-010
Knob	1307031-001

4.4 Technical data

Dimensions L x W x H

Chiropro 3 rd Gen unit	240 x 240 x 102 mm
Chiropro 3 rd Gen unit (with bracket)	240 x 240 x 482 mm
Pedal	250 x 205 x 54 mm
Pedal (with handle)	250 x 205 x 144 mm
Motor cable (REF 1601009)	L 2.0 m
Pedal cable	L 2.9 m

The pedal is waterproof (IP X8 in accordance with IEC 60529).

Weight

Chiropro 3 rd Gen unit	2.2 kg
Pedal	830 g
Bracket	115 g
Cable	105 g

Electrical data

Voltage	100 – 240 VAC
Frequency	50-60 Hz

Environmental conditions

Environmental conditions	Operating	Transport and storage (max. 15 weeks)
Temperature	+5°C (41°F) to +35°C (95°F)	-25°C (-13°F) to +70°C (158°F)

Environmental conditions	Operating	Transport and storage (max. 15 weeks)
Relative humidity (including condensation)	30% to 80%	10% to 100%
Atmospheric pressure	700 hPa to 1060 hPa	500 hPa to 1060 hPa

CAUTION

Do not use Chiropro 3rd Gen outside the range of operating temperature.

Classification

Class IIa in accordance with European Directive 93/42/EEC concerning medical devices.

Electric insulation class

Class I per IEC 60601-1 (apparatus protected against electric shocks).

CAUTION

The device must be only used by the operator.

Applied parts (per IEC 60601-1):

MX-i LED 3 rd Gen micromotor	REF 1601008-001
Straight handpiece 1:1	REF 1600052-001
CA 20:1 L	REF 1600598-001
CA 20:1 L Micro-Series	REF 1600692-001
CA 20:1 L KM	REF 1600785-001
CA 20:1 L KM Micro-Series	REF 1600786-001
Irrigation lines	REF 1500984-010
KM Irrigation lines	REF 1501635-010

Degree of ingress protection

IP 41 (protection against insertion of objects larger than 1 mm and dripping water (vertically falling drops)).

Memory

Memory storage of 5 steps settings including adjustment of speed, torque, rotation direction, irrigation, and contra-angle ratio for each step.

Languages

English.

Bracket for physiological liquid flask

Stainless steel.

Peristaltic pump

Pump delivery	From 30 to 150 ml/min. (5 levels)
Hose for pump	External Ø 5.60 mm Internal Ø 2.40 mm
Wall thickness	1.60 mm

Intended for use with:

See instructions for use

MX-i LED 3 rd Gen micromotor	REF 2100245
Cable MX-i LED 3 rd Gen	REF 2100163
Contra-angle CA 20:1 L, light	REF 2100209
Contra-angle CA 20:1 L Micro-Series, light	REF 2100209
Contra-angle CA 20:1 L KM, light	REF 2100209
Contra-angle CA 20:1 L KM Micro-Series, light	REF 2100209
Straight Handpiece 1:1	REF 2100046

CAUTION

The use of the system with other handpieces, motors or cables has not been validated/certified (speed and torque values are not guaranteed in this case).

List of errors & Troubleshooting

See chapter "10 List of errors & Troubleshooting" on page 20.

4.5 Environmental protection and information for disposal



The disposal and/or recycling of materials must be performed in accordance with the legislation in force.



Separate collection of electric and electronic equipment and accessories in view of recycling.

Electrical and electronic equipment may contain dangerous substances which constitute health and environmental hazards. The user must return the device to its dealer or establish direct contact with an approved body for treatment and recovery of this type of equipment (European Directive 2002/96/EC).

4.6 Electromagnetic compatibility (technical description)

4.6.1 Precautions of use

This electronic control is in compliance with electrical safety standards in line with standard IEC 60601-1, edition 3.1, and those governing electromagnetic compatibility in line with standard IEC 60601-1-2, fourth edition.

CAUTION

The device must be used by a competent person, in particular in compliance with the legal provisions in force regarding occupational safety, health and accident prevention measures, and the current instruction for use. According to these measures, the user has the following obligations:

- to only use devices that are in perfect working order
- to make sure that the device is used solely for the purpose for which it is intended
- avoid contact with liquids.

4.6.2 Electromagnetic compatibility warnings

CAUTION

The Chiropro 3rd Gen complies with the EMC requirements according to IEC 60601-1-2. Radio transmitting equipment, cellular phones, etc., should not be used in the immediate vicinity of the device, since this could affect its operation. The device is not suitable for being used close to high-frequency surgical equipment, magnetic resonance imaging (MRI) and other similar devices where the intensity of electromagnetic disturbances is high. In any case, ensure that no high frequency cables are routed above or near the device. If in doubt, contact a qualified technician or Bien-Air Dental SA.

Portable RF communications equipment (including peripherals such as antenna cables and external antennas) should be used no closer than 30 cm (12 inches) to any part of the Chiropro 3rd Gen, including cables specified by the manufacturer. Otherwise, degradation of the performance of this equipment could result.

CAUTION

The use of accessories, transducers and cables other than those specified, with the exception of transducers and cables sold by Bien-Air Dental SA as spare parts for internal components, may result in increased emissions or decreased immunity.

4.6.3 Electromagnetic compatibility – emissions & immunity

Guidance and manufacturer's declaration – Electromagnetic emissions

The Chiropro 3rd Gen is intended for use in the electromagnetic environment specified below. The customer or the user of the Chiropro 3rd Gen must ensure that it is actually used in such an environment.

Emissions test	Compliance	Electromagnetic environment - guidance
RF emissions CISPR 11	Group 1	The Chiropro 3 rd Gen uses RF energy for its internal operation only. Therefore, its RF emissions are very low and are not likely to cause any interference in nearby electronic equipment.
RF emissions CISPR 11	Class B	The Chiropro 3 rd Gen is suitable for use in any building, including residential buildings and those directly connected to the public low-voltage power supply network that supplies buildings used for residential purposes.
Harmonic emissions IEC 61000-3-2	Class A	
Emissions due to voltage fluctuations IEC 61000-3-3	Conforming	

Guidance and manufacturer's declaration – Electromagnetic immunity

The Chiropro 3rd Gen is intended for use in the electromagnetic environment specified below. The customer or the user of the Chiropro 3rd Gen must ensure that it is actually used in such an environment.

Immunity test	IEC 60601 test level	Compliance level	Electromagnetic environment - guidance
Electrostatic discharge (ESD) IEC 61000-4-2	±8 kV contact ±2 kV air ±4 kV air ±8 kV air ±15 kV air	±8 kV contact ±2 kV air ±4 kV air ±8 kV air ±15 kV air	Floors should be wood, concrete or ceramic tile. If floors are covered with synthetic material, the relative humidity should be at least 30%.
Electrical fast transient/burst IEC 61000-4-4	±2 kV for power supply lines ±1 kV for other lines	±2 kV for power supply lines N.A.	Mains power quality should be that of a commercial or hospital environment.
Surge IEC 61000-4-5	±0.5 kV line to line ±1 kV line to line ±0.5 kV line to earth ±1 kV line to earth ±2 kV line to earth	±0.5 kV line to line ±1 kV line to line ±0.5 kV line to earth ±1 kV line to earth ±2 kV line to earth	Mains power quality should be that of a commercial or hospital environment.
Voltage dips, short interruptions and voltage variations on power supply input lines IEC 61000-4-11	0% U_T for 0.5 cycle, at 0°, 45°, 90°, 135°, 180°, 225°, 270° and 315° 0% U_T for 1 cycle and 70% U_T for 25/30 cycles at 0° 0% U_T for 250 cycles at 0°	0% U_T for 0.5 cycle, at 0°, 45°, 90°, 135°, 180°, 225°, 270° and 315° 0% U_T for 1 cycle and 70% U_T for 25/30 cycles at 0° 0% U_T for 250 cycles at 0°	Mains power quality should be that of a commercial or hospital environment. If the user of the Chiropro 3 rd Gen requires continued operation during mains power interruptions, it is recommended that the Chiropro 3 rd Gen be powered from an uninterruptible power supply or a battery.
Magnetic field due to mains frequency (50/60 Hz) IEC 61000-4-8	30 A/m	30 A/m	Magnetic fields generated by the mains frequency should be at levels characteristic of a typical location in a typical commercial or hospital environment.

Immunity test	IEC 60601 test level	Compliance level	Electromagnetic environment - guidance	
Conducted disturbances induced by RF fields IEC 61000-4-6	$3 V_{RMS}$ 0,15 MHz – 80 MHz $6 V_{RMS}$ in ISM bands 0,15 MHz – 80 MHz 80% AM at 1 kHz	$3 V_{RMS}$ 0,15 MHz – 80 MHz $6 V_{RMS}$ in ISM bands 0,15 MHz – 80 MHz 80% AM at 1 kHz	Field strengths from fixed RF transmitters, as determined by an electromagnetic site survey ^a should be less than the compliance level in each frequency range. Interference may occur in the vicinity of equipment marked with the following symbol: 	
Radiated RF EM fields IEC 61000-4-3	$3 V/m$ 80 MHz – 2,7 GHz 80 % AM at 1 kHz	$3 V/m$ 80 MHz – 2,7 GHz 80 % AM at 1 kHz		
Proximity fields from RF wireless communications equipment IEC 61000-4-3	Test freq. [MHz]	Max. power [W]	Immunity test level [V/m]	Distance: 0.3 m
	385	1.8	27	
	450	2	28	
	710, 745, 780	0.2	9	
	810, 870, 930	2	28	
	1720, 1845, 1970	2	28	
	2450	2	28	
5240, 5500, 5785	0.2	9		
NOTE: U_T is the AC mains voltage prior to application of the test level. Essential performance per IEC 60601-1: The essential performance is to maintain the visual luminous intensity of the LED and the motor speed. The maximum speed deviation is $\pm 5\%$.				

a. Field strengths from fixed transmitters, such as base stations for radio (cellular/cordless) telephones and mobile field radios, amateur radios, AM and FM radio broadcasts and TV broadcasts cannot be predicted theoretically with accuracy. To assess the electromagnetic environment due to fixed RF transmitters, an electromagnetic site survey should be considered. If the measured field strength in the location in which the Chiropro 3rd Gen is used exceeds the RF compliance level mentioned above, the Chiropro 3rd Gen should be observed to verify that it is operating normally. If abnormal operation is observed, additional measures may be necessary, such as reorienting or relocating the Chiropro 3rd Gen.

5 Installation



FIG. 1



FIG. 2

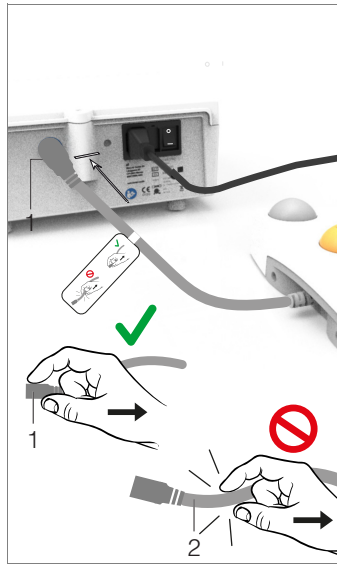

FIG. 3



FIG. 4

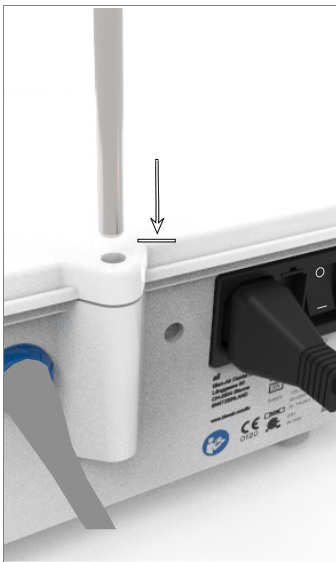

FIG. 5

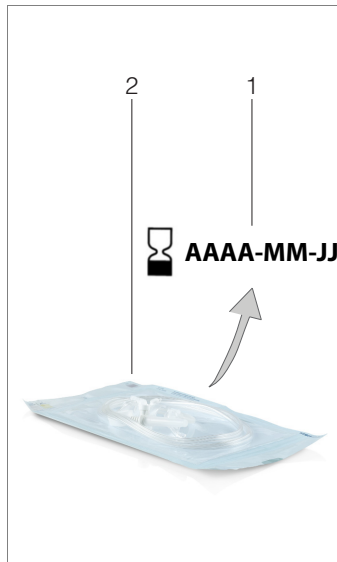

FIG. 6

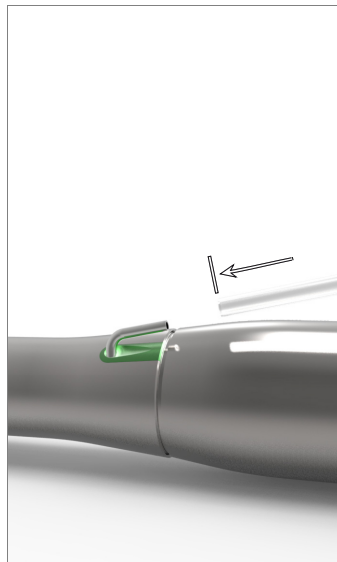

FIG. 7

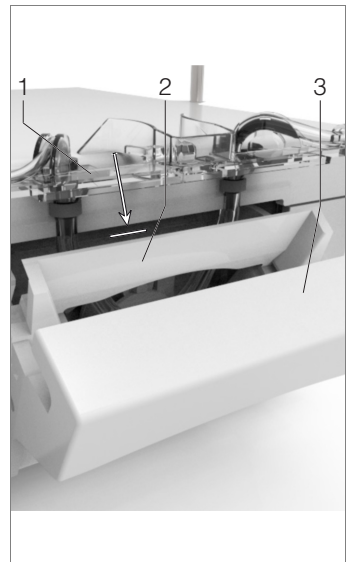

FIG. 8

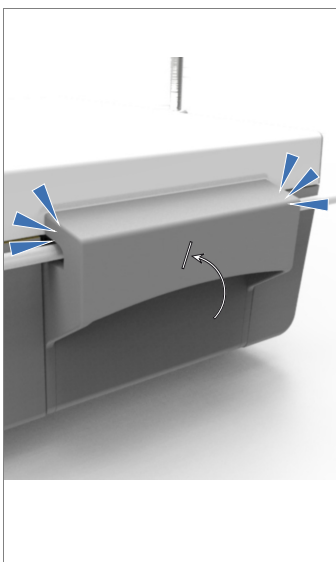

FIG. 9



FIG. 10



FIG. 11

5.1 Install the Chiropro 3rd Gen system

FIG. 1

A. Place the Chiropro 3rd Gen on a flat surface capable of bearing its weight.

⚠ CAUTION

It may be positioned on a table, on a trolley or any other surface but in no circumstances on the floor.

FIG. 2

B. The fuse box may be opened with a screwdriver.
100 - 240 VAC = fuse T4.OAH 250 VAC REF 1307312-010.

To replace a fuse, see chapter "11.4 Replacement of fuses" on page 23.

C. Connect the power cable (1) to the connector (2).

Note 1

⚠ CAUTION

The power plug is used for disconnection in case of problems, it must be easily accessible at all times.

FIG. 3

D. Connect the pedal cable to the input provided on the rear panel, guiding the connector and plug by means of the index pin on the connector.

⚠ CAUTION

Do not lift the pedal holding the connection cable.
To disconnect the pedal cable pull the cable socket connector (1).
Do not pull the cable (2) without disconnecting the cable socket before.

FIG. 4

E. Connect the MX-i LED 3rd Gen micromotor cable to the motor output, guiding the connector and plug by means of the index pin on the connector.

FIG. 5

F. Align and attach the bracket to the housing provided on the rear of the console and suspend the flask or bottle.

FIG. 6

G. Check the packaging integrity, as well as the expiry date of the irrigation line on the label (1).

⚠ CAUTION

The medical device must be used only with lines supplied by Bien-Air Dental to ensure trouble-free operation. These lines are sterile and for single use. Re-use may result in microbiological contamination of the patient.

H. Remove the single-use sterile irrigation line (2) from its pouch.

FIG. 7

I. Connect the flexible hose of the irrigation line to the spray tube of the handpiece or contra-angle.

FIG. 8

J. Install the peristaltic cassette (1) in the peristaltic pump (2).
Check that the cassette is clipped correctly.

FIG. 9

K. Close the pump lid (3). If there is resistance to closing, open the lid again and check the correct positioning of the cassette. When the lid is correctly closed, the user should hear a click sound.

⚠ CAUTION

Do not run the pump while the lid is open.

⚠ CAUTION

Do not run the pump without irrigation line.

⚠ CAUTION

Risk of pinching!

FIG. 10

L. Perforate the cap of the physiological liquid flask with the pointed end of the irrigation line after removing the protective cap.

⚠ CAUTION

There is no detection of empty physiological liquid flask! Always check the content of the flask before operating.

FIG. 11

M. Attach the irrigation line on the motor cable using the 3 attachment collars REF 1307727-010.

5.2 On/off procedure

The device can be switched on and off in complete safety using the main switch on the Chiropro 3rd Gen.

⚠ CAUTION

Do not switch off the device while the motor is running.

NOTES

1 The equipment is powered by the mains power supply (100 - 240 VAC / 150W / 50-60Hz).

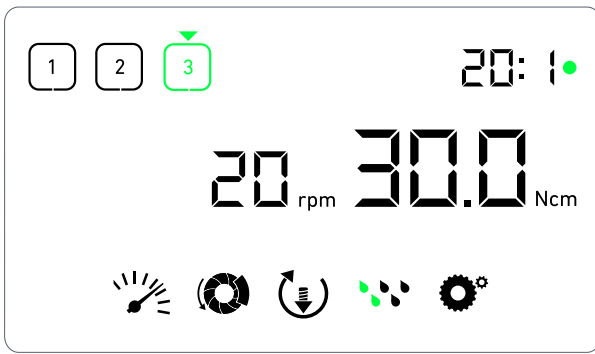

FIG. 1

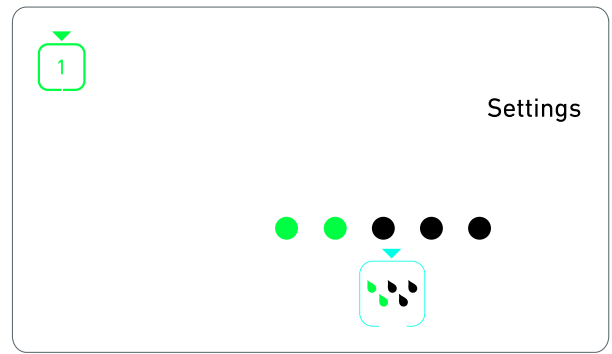

FIG. 2

6 Interface overview

6.1 Chiropro 3rd Gen modes

The Chiropro 3rd Gen allows to visualize and control operation parameters by the means of the LCD display.

A unique screen allows to use the following modes:

FIG. 1

- Operation mode (to perform an operation in 3 steps)

See chapter "7 Operation" on page 14 for details.

FIG. 2

- Settings mode (to set up operation parameters)

See chapter "8 Settings" on page 16 for details.

FIG. 3

- Special modes (to test system and reset settings)

See chapter "9 Special modes" on page 18 for details.

FIG. 4

A. Long press on the rotating knob (1) to switch between Operation and Settings modes.

Note 1

See chapter "6.2 Rotating knob functions overview" on page 12 for details.

See chapter "9 Special modes" on page 18 for entering special modes.

6.2 Rotating knob functions overview

Note 2

Knob action	Description
CW rotation	Increase current value, go to the element on the right
CCW rotation	Decrease current value, go to the element on the left
One short press (Operation mode)	Go to the next programmed step, acknowledge error messages
One short press (Settings mode)	Enter selected setting, validate and store the current setting value, exit the current setting, acknowledge error messages
One long press	Switch between Operation and Settings modes
Double short press	Enter special modes (only when gear ratio is selected in settings mode)

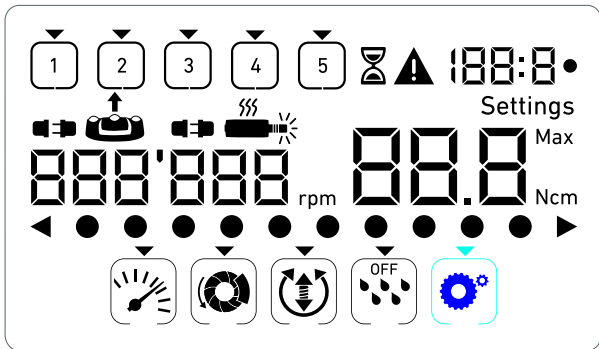

FIG. 3



FIG. 4

6.3 Sound alerts



Sound alert	Description
One short beep	Activating irrigation, going to next step, and switching rotation direction to FORWARD
Two short beeps	Deactivating irrigation, and switching rotation direction to REVERSE
Two long beeps	Switching from low speed to high speed programmed step
Alternate short beeps	Warning notifications
Alternate medium beeps	Micromotor REVERSE running indicator
Alternate long beeps	System failure notification

NOTES

- 1 The Operation mode is the default startup mode.
- 2 Any knob or pedal action will be ignored when the motor is running.

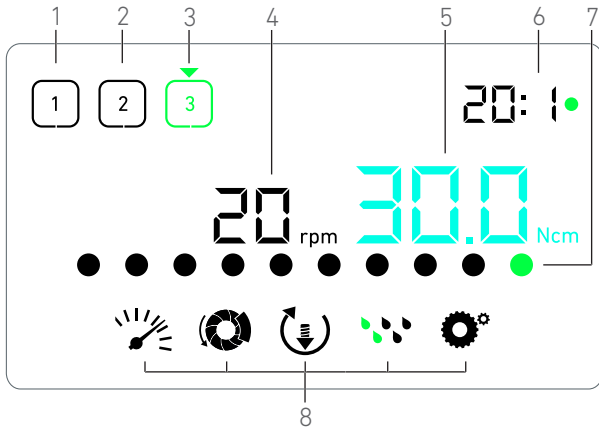

FIG. 1

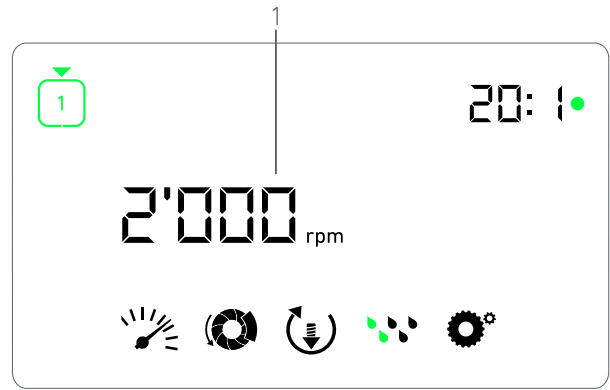

FIG. 2

7 Operation

7.1 Operation screen description

FIG. 1

The Operation screen differs whether the micromotor is stopped or running and depending on the active step.

It allows to perform an operation in 3, 4 or 5 predefined steps P1, P2, P3, P4, P5 (which can respectively be used to program settings for the bone preparation, drilling, threading and implant insertion phases), and displays the following information:

- (1) Step P1 (inactive step, in black)
- (2) Step P2 (inactive step, in black)
- (3) Step P3 (active step, in green)

P4 and P5 steps are disabled by default, see "Number of steps" on page 18 for enabling them.

- (4) Speedometer

Note 1

- (5) Torquemeter

Note 2

- (6) Contra-angle ratio

Note 3

- (7) Bar graph for torque

Note 4

- (8) Operation settings symbols

See chapter "8 Settings" on page 16 for details on adjusting settings.

7.2 Perform an operation, steps P1 and P2

FIG. 2

A. Operate by pressing the footpedal to adjust the MX-i LED 3rd Gen micromotor speed.

Inactive steps symbols turn off when the motor is running. Speedometer displays real-time speed value in black.

Note 5 - 6 - 7

FIG. 3

B. If necessary, release the footpedal to perform the following actions:

- Speedometer (1) displays the set micromotor maximum reachable speed in cyan.

- Turn the knob CW or CCW to respectively increase or decrease the micromotor maximum reachable speed (quick setting mode).

The speedometer is cyan and displays the set micromotor maximum reachable speed (1).

Note 8

- Long press on the knob to change operation settings.

The Settings mode is displayed.

See chapter "8 Settings" on page 16 for details.

- Long press on the orange button to activate the 5 Ncm torque boost.

Note 9

C. Short press on the footpedal's orange button or on the knob to go to the next step.

The next step symbol turns green and the step's last used settings are restored.

Note 7 - 10

7.3 Perform an operation, steps P3, P4 and P5

FIG. 4

A. In steps P3 (1), P4 and P5, operate by pressing the footpedal to adjust the MX-i LED 3rd Gen micromotor speed.

All inactive steps symbols turn off when the motor is running.

Speedometer (2) displays real-time value.

Torquemeter (3) displays real-time value.

The torque bar (5) displays ratio between the real-time torque value (represented by cyan dots when the micromotor is running) and the maximum reached torque (represented by green dot).

Note 5 - 6 - 7

B. If necessary, release the footpedal to perform the following actions:

Torquemeter (3) displays maximum reached value together with the **Max** symbol (4).

Torque bar (5) dots that were displayed in cyan turn black, except for the maximum value dot which turns green.

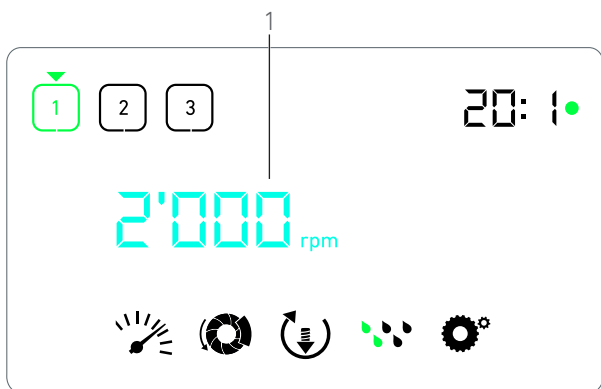

FIG. 3

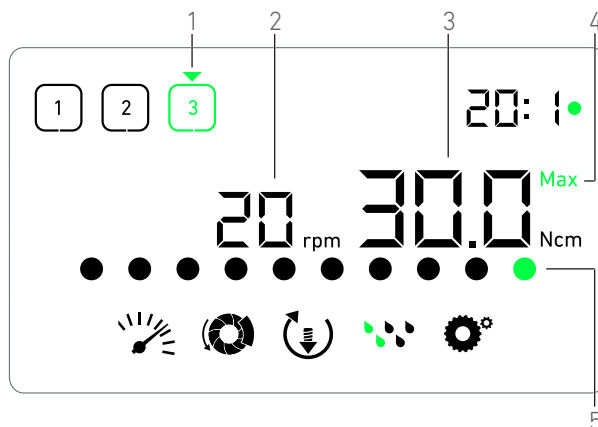

FIG. 4

- Turn the knob CW or CCW to respectively increase or decrease the micromotor maximum reachable torque (quick setting mode).

↳ The torquemeter (3) turns cyan and displays the set micromotor maximum reachable torque.

Note 11

- Long press on the knob to change operation settings.

See chapter "8 Settings" on page 16 for details.

- Long press on the orange button to activate the 5 Ncm torque boost.

Note 9

C. Short press on the footpedal's orange button or on the knob to go to the next step.

↳ The next step symbol turns green and the step's last used settings are restored.

Note 7 - 10

NOTES

1 Real-time speed value is displayed in black when the MX-i LED 3rd Gen micromotor is running. Maximum reachable speed value stored is displayed in cyan when the MX-i LED 3rd Gen micromotor is not running, in steps P1 and P2.

2 Torquemeter is only displayed when micromotor speed is below 100 RPM in steps P1 and P2.

3 The contra-angle ratio is cyan-colored for direct-drive and green-colored for reduction gears.

4 Torque bar graph is only displayed when micromotor speed is below 100 RPM.

5 Each step settings are restored from the corresponding step last used settings, excluding quick settings made directly in the Operation mode.

6 In REVERSE mode, the rotation direction symbol (↺) blinks and there is a sound alert (alternate medium beeps). The Torque value is automatically increased in REVERSE mode when torquemeter is displayed. The torque value can be increased from 0 to 10 Ncm, see chapter see "Reverse torque boost value" on page 18 to adjust it.

7 Actions on footpedal's buttons have no effect when the micromotor is running.

8 Changing the torque in steps P1 or P2 can only be performed through the Settings mode.

9 The torque boost can only be activated when the torquemeter is displayed in Operation mode, in low speed steps (<100 RPM).

10 For safety reasons, the speed setting icon turns red and blinks together with the speedometer for 2 seconds when switching from low speed to high speed (≥100 RPM) step.

11 Changing the speed in steps P3, P4 and P5 can only be performed through the settings mode.

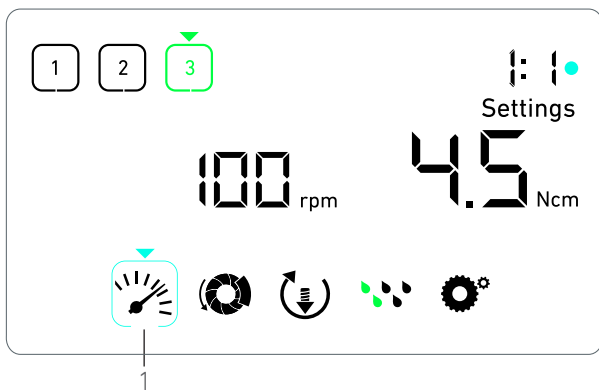

FIG. 1

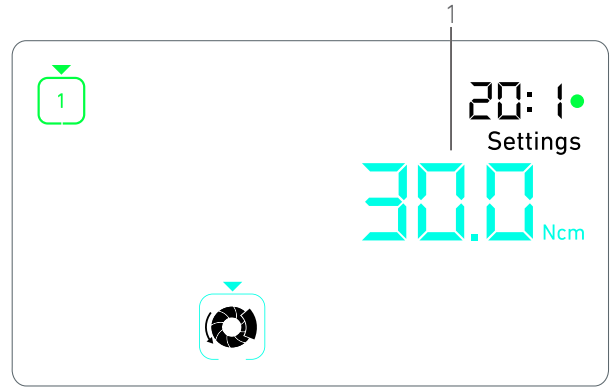

FIG. 2

8 Settings

FIG. 1

The Settings mode allows changing all parameters of each step. It is accessed by long pressing the knob from the Operation mode and leaved by also long pressing the knob or by running the motor.

All changes made in this mode are automatically saved for the corresponding step.

Note 1

A. From the Settings mode menu, navigate through the operation parameters by turning the knob CW or CCW.

↪ The selected parameter symbol (1) is encased in a cyan square and an arrow points on it.

B. If necessary, short press on the footpedal's orange button to go to the next step without going back to the Operation mode.

↪ The Settings mode is still displayed, the next step symbol turns green and the step's last used settings are restored.

C. Short press on the knob to change the selected parameter setting (setting sub-mode).

↪ The selected setting sub-mode is displayed.

8.1 MX-i LED 3rd Gen micromotor speed

A. From the Settings mode menu, select the  symbol and short press on the knob to change maximum reachable speed.

FIG. 2

B. Turn the knob CW or CCW to respectively increase or decrease micromotor maximum reachable speed.

↪ The speedometer (1) displays the set maximum reachable speed.

C. Short press on the knob to exit speed setting.

↪ New maximum reachable speed is saved and the Settings mode menu is displayed again, FIG. 1.

8.2 MX-i LED 3rd Gen micromotor torque

A. From the Settings mode menu, select the  symbol and short press on the knob to change maximum reachable torque.

FIG. 3

B. Turn the knob CW or CCW to respectively increase or decrease micromotor maximum reachable torque.

↪ The torquemeter (1) displays the set maximum reachable torque.

C. Short press on the knob to exit torque setting.

↪ New maximum reachable torque is saved and the Settings mode menu is displayed again, FIG. 1.

8.3 MX-i LED 3rd Gen micromotor rotation direction

A. From the Settings mode menu, select the  symbol and short press on the knob to change rotation direction.

Note 1

B. Turn the knob CW or CCW to alternatively toggle between FORWARD  and REVERSE  micromotor rotation.

C. Short press on the knob to exit rotation direction setting.

↪ Rotation direction is saved and the Settings mode menu is displayed again.

Note 2

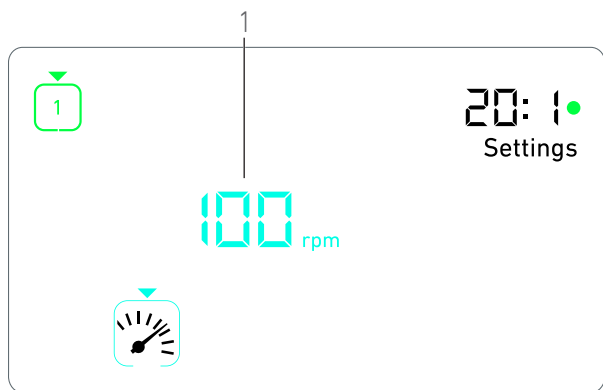

FIG. 3

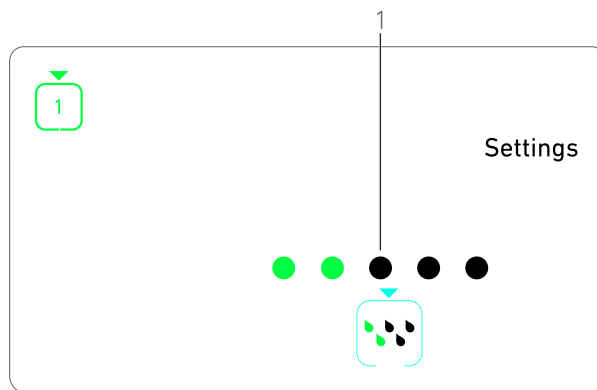



FIG. 4

8.4 Irrigation level

A. From the Settings mode menu, select the  symbol and short press on the knob to change irrigation level.

Note 1

FIG. 4

B. Turn the knob CW or CCW to set up the irrigation level (1). 6 levels of adjustment are possible: irrigation OFF, 30ml/min, 60ml/min, 90ml/min, 120ml/min, 150ml/min.

Note 3

C. Short press on the knob to exit irrigation level setting.

↳ Irrigation level is saved and the Settings mode menu is displayed again.

8.5 Contra-angle ratio

A. From the Settings mode menu, select the  symbol and short press on the knob to change the contra-angle ratio.

B. Turn the knob CW or CCW to change the contra-angle ratio.

Note 4

C. Short press on the knob to exit the contra-angle ratio setting.

↳ The contra-angle ratio is saved and the Settings mode menu is displayed again.

NOTES

1 The rotation direction and the irrigation level symbols differ depending on the actual settings.

2 The Torque value is automatically increased in REVERSE mode when torquemeter is displayed. The torque value can be increased from 0 to 10 Ncm, see chapter "Reverse torque boost value" on page 18 to adjust it.

3 When setting the irrigation level to OFF, all dots (1) are displayed in black. Irrigation level is off when the irrigation is completely turned off by means of the footpedal's blue button, regardless of the active step. In this case, the OFF symbol is displayed in Operation mode. The irrigation is considered as a quick setting and therefore is turned ON when starting again from step P1.

4 The contra-angle ratio is cyan-colored for direct-drive and green-colored for reduction gears.

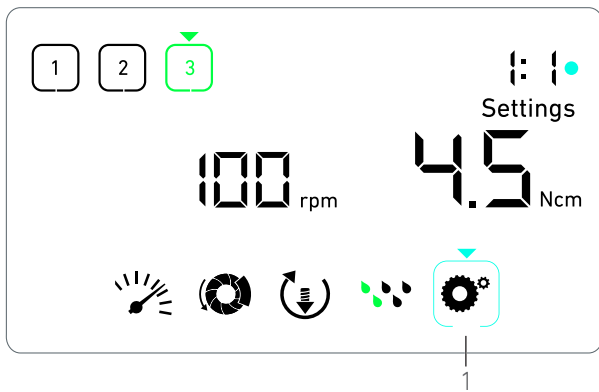

FIG. 1

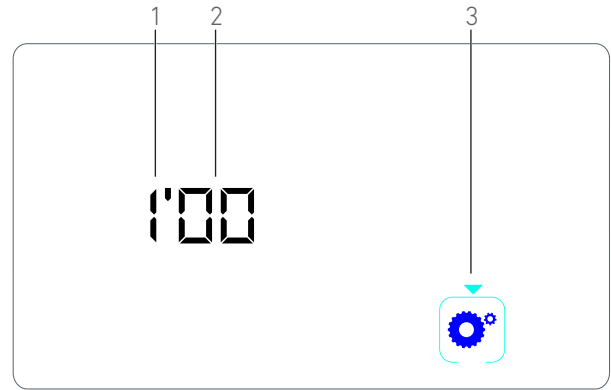

FIG. 2

9 Special modes

The special modes allow to, in the following order:

- Display software version;
- Test LCD display;
- Define number of steps (3, 4 or 5);
- Define reverse torque boost value;
- Restore factory settings.

Note 1

A. From the Operation mode, long press on the rotating knob to enter Settings modes.

↳ The Settings mode is displayed.

FIG. 1

B. Turn the knob CW or CCW to select the contra-angle ratio symbol  (1).

↳ The contra-angle ratio symbol is encased in a cyan square and an arrow points on it.

Software version

FIG. 2

C. Double short press on the knob to enter special modes.

↳ The contra-angle ratio symbol (3) turns blue to differentiate it from the ratio change cyan symbol.

↳ The software version is displayed as following:

- (1) Major version
- (2) Minor version

LCD display test

FIG. 3

D. Short press on the knob to test LCD display.

↳ All dots are displayed in black, except for the contra-angle ratio symbol (1).

Number of steps

E. Short press on the knob to define the number of steps.

↳ The step number screen is displayed.

F. Turn the knob CW or CCW to alternatively display the **3, 4 or 5** text.

G. Short press on the knob to define the number of steps.

Reverse torque boost value

Reverse torque boost allows an automatic increase of torque value when in REVERSE mode, in order to ease bur rotation when stuck.

H. Short press on the knob to define reverse torque boost value.

↳ The reverse torque boost screen is displayed.

I. Turn the knob CW or CCW to alternatively display the **0, 5 or 10** text.

J. Short press on the knob to define no boost value when **0** is displayed, or short press on the knob to respectively define 5 Ncm or 10 Ncm boost value when **5** or **10** is displayed.

Settings reset

FIG. 4

K. Short press on the knob to display factory settings reset screen.

↳ The factory settings reset screen is displayed.

L. Turn the knob CW or CCW to alternatively display the **reset yes** or **reset no** text (1).

Note 3

M. Short press on the knob to restore factory settings when the **reset yes** text is displayed, or short press to go back to the Settings mode when the **reset no** text is displayed.

↳ Reset can take up to 2 seconds. Meanwhile, the  symbol is displayed, and the **yes** text is turned off. When reset is done, the Settings mode is displayed again.

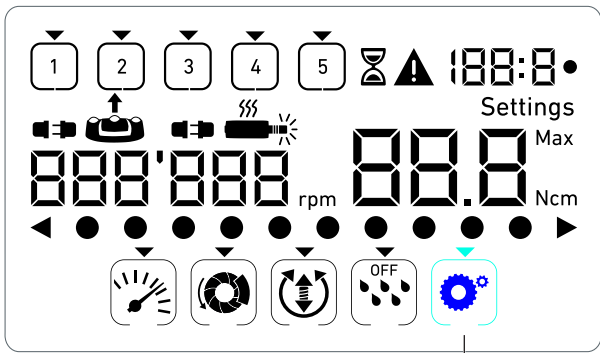

FIG. 3

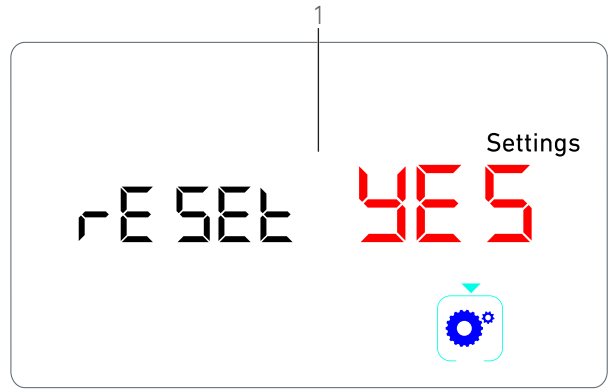







FIG. 4

NOTES

- 1 Pressing the footpedal has no effect in the Special modes.
- 2 Go through all the special modes to display the Settings mode again.
- 3 The **reset no** text is displayed by default.

10 List of errors & Troubleshooting

10.1 Safety warning (operating)

Warning description	Message	Cause of warning	Action
Motor overheating		Excessive power demand of the MX-i LED 3 rd Gen micro-motor.	Avoid extended use. Let system cool down.
Release pedal		<ul style="list-style-type: none"> Pedal is pressed when accessing settings sub-modes. Pedal is pressed during device startup. Pedal is pressed after recovering from an error. 	<ul style="list-style-type: none"> Confirm setting by pressing the knob. Release footpedal and press it again. Release footpedal and press it again.
Low to high speed step transition	 Speedometer blinking.	User switches from low speed to high speed (≥ 100 RPM) step.	No action needed, the warning disappears after 2 seconds.
Motor jammed		Motor is jammed for more than 2 seconds. Motor power supply is cut to avoid overheating.	Release footpedal, release the bur and press footpedal again.
Footpedal not connected		Pedal is not connected to device.	Connect pedal to the device.
Motor not connected		Motor is not properly connected to device, Motor hardware is damaged.	<ol style="list-style-type: none"> Acknowledge error. (Re)connect the motor cable. If problem persists, contact Bien-Air Dental SA.

10.2 Device operating error

Error description	Cause of error	When	Action
ERROR 1			
Motor short-circuit	Electrical failure: short-circuit between motor phases.	In running mode.	Replace motor and/or cable.
ERROR 2			
Main controller error	Other fault condition detected by software.	Any time.	1. Switch off system. 2. Contact Bien-Air Dental SA.
ERROR 3			
Motor driver communication timeout error	Failure of DMX controller. Failure of main controller RS-232.	In running mode.	1. Switch off system. 2. Contact Bien-Air Dental SA.
ERROR 4			
Invalid EEPROM memory	Failure of EEPROM memory.	Any time.	Contact Bien-Air Dental SA. Acknowledging this error allows the operator to work normally but it will not allow settings to be saved or restored. This error will appear at each save or restoration attempt.
ERROR 5			
Motor drive over temperature	Motor overload in a high temperature environment. Failure of DMX controller.	Any time.	1. Wait for system cooling. 2. If problem persists, contact Bien-Air Dental SA.
ERROR 6			
Motor driver under voltage error	Motor overload in a high temperature environment. Failure of power supply.	Any time.	1. Acknowledge error. 2. If problem persists, contact Bien-Air Dental SA.
ERROR 7			
Motor driver over voltage error	Failure of power supply. Tool used has a too high inertia.	Any time.	1. Acknowledge error. 2. If problem persists, contact Bien-Air Dental SA.
ERROR 8			
Irrigation pump general failure	Electrical failure: short-circuit to ground or to supply. Electrical failure: short-circuit between motor phases.	In running mode.	1. Switch off sytem. 2. Contact Bien-Air Dental SA.
ERROR 9			
Knob failure	Electrical failure of knob encoder.	Any time.	1. Switch off sytem. 2. Contact Bien-Air Dental SA.



FIG. 1

11 Maintenance

⚠ CAUTION

Only use original Bien-Air Dental maintenance products and parts or those recommended by Bien-Air Dental. Using other products or parts may cause operational failure and/or void the guarantee.

11.1 Servicing

Never disassemble the device. For any modification and repair, we recommend that you contact your regular supplier or Bien-Air Dental SA directly.

Note 1

11.2 Cleaning & disinfection

FIG. 1

- Disinfect the surfaces of the Chiropro 3rd Gen unit and footpedal by gently rubbing with a clean cloth soaked in a suitable product (i.e. Bien-Air Dental Spraynet or isopropyl alcohol for about 15 sec.).
- Remove the knob (1) and sterilize it a class B autoclave at 135°C.

Note 2

- Do not immerse in disinfectant solution.
- Not designed for an ultrasonic bath.
- Use a new sterile irrigation line for each patient.
- Use a new sterile protective sheet for each patient.

11.3 Important

For maintenance:	See instructions for use
MX-i LED 3 rd Gen micromotor	REF 2100245
Cable for micromotor	REF 2100163
Contra-angle CA 20:1 L, light	REF 2100209
Contra-angle CA 20:1 L	
Micro-Series, light	REF 2100209
Contra-angle CA 20:1 L KM, light	REF 2100209
Contra-angle CA 20:1 L KM	
Micro-Series, light	REF 2100209
Straight Handpiece 1:1	REF 2100046

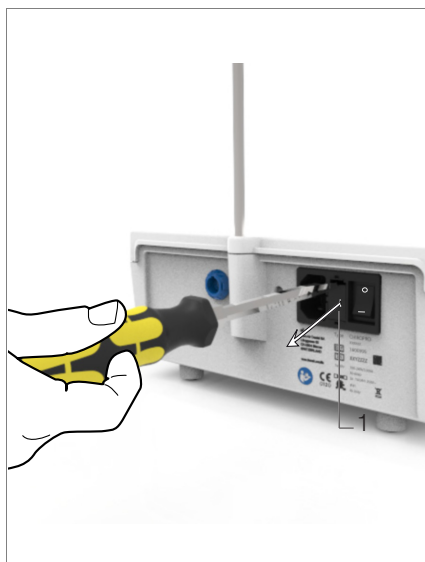

FIG. 2

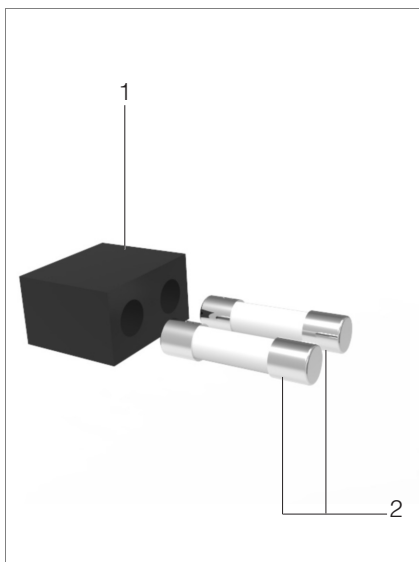

FIG. 3

11.4 Replacement of fuses

- A. Switch off the Chiropro 3rd Gen unit.
- B. Disconnect the mains cable.

⚠ CAUTION

The power cable must be disconnected at least 10 seconds before opening the fusebox.

FIG. 2

- C. Remove the fuse box (1) with a flat screwdriver.

FIG. 3

- D. Replace the fuses (2) by the new ones and put the fuse box back (1) in place.

⚠ CAUTION

Only use fuses T4.0AH 250 VAC REF 1307312-010.

NOTES

- 1 Bien-Air Dental SA recommends the user to have its dynamic instruments regularly checked or inspected.
- 2 The knob is hold magnetically. There is no need to preserve its angular position when removing it or putting it back in place.

12 General information and guarantee

12.1 General information

The device must be used by qualified professionals in compliance with the current legal provisions concerning occupational safety, health and accident prevention measures, and these instructions for use. In accordance with such requirements, the operators:

- must only use devices that are in perfect working order; in the event of irregular functioning, excessive vibration, abnormal heating or other signs that may indicate malfunction of the device, the work must be stopped immediately; in this case, contact a repair center that is approved by Bien-Air Dental SA;
- must ensure that the device is used only for the purpose for which it is intended, must protect themselves, their patients and third parties from any danger.

12.2 Terms of guarantee

Bien-Air Dental SA grants the user a guarantee covering all functional defects, material or production faults.

The device is covered by this guarantee from the date of invoicing for:

- 12 months for the hose;
- 24 months for the Chiropro 3rd Gen unit and CA 20:1 L Micro-Series;
- 36 months for the MX-i LED 3rd Gen micromotor.

In case of justified claim, Bien-Air Dental SA or its authorized representative will fulfill the company's obligations under this guarantee by repairing or replacing the product free of charge. Any other claims, of whatever nature, in particular in the form of a claim for damages and interest, are excluded.

Bien-Air Dental SA shall not be held responsible for damage or injury and the consequences thereof, resulting from:

- excessive wear and tear
- improper use
- non-observance of the instructions for installation, operation and maintenance
- unusual chemical, electrical or electrolytic influences
- poor connections, whether of the air, water or electricity supply.

The guarantee does not cover flexible "fiber optic" type light conductors, or any parts made of synthetic materials.

The guarantee shall become null and void if the damage and its consequences are due to improper manipulation of the product, or modifications to the product carried out by persons not authorized by Bien-Air Dental SA.

Claims under the terms of the guarantee will be considered only on presentation, together with the product, of the invoice or the consignment note, on which the date of purchase, the product reference and the serial no. should be clearly indicated.

Please refer to the General Terms and Conditions of Sale on www.bienair.com.



Bien-Air Dental SA
Länggasse 60
Case postale
2500 Bienne 6, Switzerland
Tel. +41 (0)32 344 64 64
Fax +41 (0)32 344 64 91
office@bienair.com

Bien-Air Deutschland GmbH
Jechtinger Strasse 11
79111 Freiburg, Germany
Tel. +49 (0)761 45 57 40
Fax +49 (0)761 47 47 28
ba-d@bienair.com

Bien-Air España, SAU
Entença, 169 Bajos
08029 Barcelona, Spain
Tel. +34 934 25 30 40
Fax +34 934 23 98 60
ba-e@bienair.com

Bien-Air USA, Inc.
5 Corporate Park
Suite 160
Irvine, CA 92606 USA
Phone +1 800-433-2436
Phone +1 949-477-6050
Fax +1 949-477-6051
dental@bienair.com

Bien-Air France Sàrl
19-21, rue du 8 Mai 1945
CS 30310
94113 Arcueil, France
Tel. +33 (0)1 49 08 02 60
Fax +33 (0)1 46 64 86 58
ba-f@bienair.com

Bien-Air Italia S.r.l.
Via Vaina 3
20122 Milano, Italy
Tel. +39 (02) 58 32 12 51
Fax +39 (02) 58 32 12 53
ba-i@bienair.com

Bien-Air UK Ltd
Arundel House
Whitworth Road
Crawley, West Sussex
RH11 7XL, England
Tel. +44 (0)1293 550 200
Fax +44 (0)1293 520 481
ba-uk@bienair.com

Bien-Air Asia Ltd.
Nishi-Ikebukuro
Daichi-Seimei Bldg. 10F
2-40-12 Ikebukuro, Toshimaku
Tokyo, 171-0014, Japan
ビエン・エア・アジア株式会社
〒171-0014
東京都豊島区池袋2-40-12
西池袋第一生命ビルディング10F
Tel. +81 (3) 5954-7661
Fax +81 (3) 5954-7660
ba-asia@bienair.com

**Beijing Bien-Air
Medical Instrument
Technology Service Co. Ltd.**
Room 1415,
Block B Lucky Tower,
No 3 Dongsanhuan Beilu,
Chaoyang District,
Beijing 100027, China
北京彼岸医疗器械
技术服务有限公司
北京市朝阳区东三
环路3号幸福大厦
B座1415室
Tel. +86 10 6567 0651
Fax +86 10 6567 8047
ba-beijing@bienair.com