

# fläsh.

Whitening Lamp

Instructions for use



**WHITEsmile®**

Made in Germany

[flaesh.com](https://flaesh.com)

<https://stomshop.pro>

# fläsh.

## Whitening System

Latest LED technology

Guided treatment function

Determination of whitening shades achieved

Cosmetic and medical tooth whitening



**WHITEsmile®**  
Made in Germany

flaesh.com

### Whitening Gel

With chlorophyll, for effective and gentle treatments.

<https://stomshop.pro>

# fläsh Whitening Lamp – Instructions for use

## Content

1.	Packaging / components	Page	4
2.	Installation	Page	5
3.	Technical specifications	Page	6
4.	fläshcard time management system	Page	7
5.	Easy lift system	Page	8
6.	Adjusting lamp / storage	Page	9
7.	Operation of the user interface		
	7.1 Home screen and functions	Page	10-11
	7.2 Tooth shade achieved determination	Page	12
	7.3 Default settings	Page	13
	7.4 Guided treatment function	Page	14-15
8.	Whitening procedure – operation of the lamp	Page	16
9.	Power supply / fuse	Page	17
10.	Cleaning	Page	17
11.	Note	Page	17
12.	Signs and Symbols	Page	18
13.	Warranty	Page	19

## 1. Packaging / components

**Content main carton:** 1 lamp body / 1 lamp head / 5 wheels / 1 counterweight with screw / 1 power cable / 3 exchangeable front parts for lamp head (blue) / 3 safety goggles according DIN EN 166: 2002-04 (REF 5050).

**Dimensions carton 1:** 142 x 40 x 24 cm, 10 kg.

**Packed separately:** 1 lamp base. **Dimensions carton 2:** 62 x 62 x 15 cm, 4 kg.

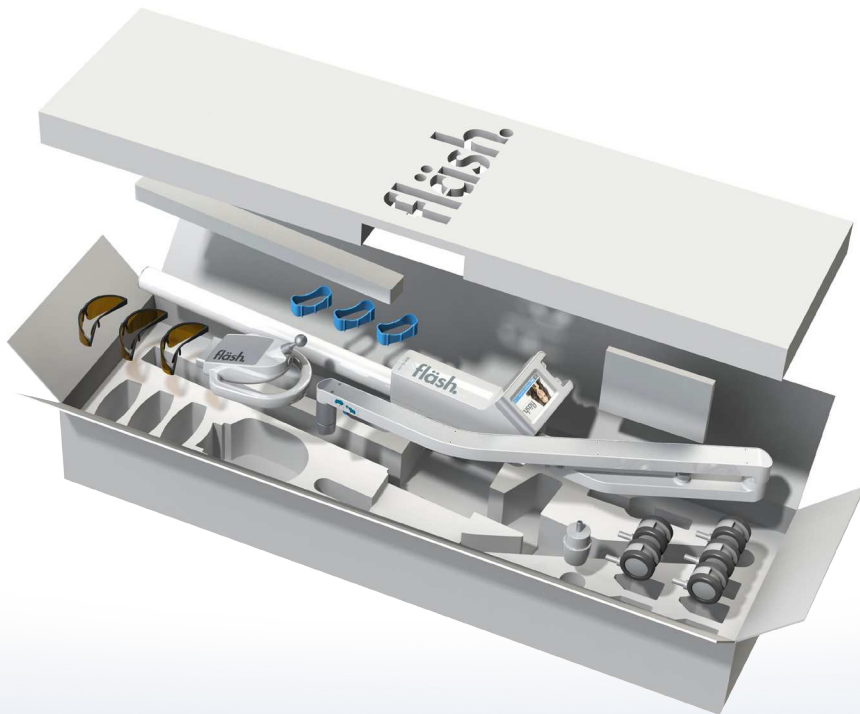

## 2. Installation



1. Attach the wheels into the base of the lamp.
2. Insert pole of lamp into base.
3. Attach counterweight with screw to fix the pole on the base. Close tight.
4. To fold up the lamp press blue button on arm and bring arm in a high position. Open screw to insert ball connector of the head. Tighten screw lightly.
5. Click power connector cable in socket on the back of the head.
6. The blue exchangeable, autoclavable silicon part has to be fixed on the lamp head.
7. Insert power cable.

**The lamp is now ready for use.**

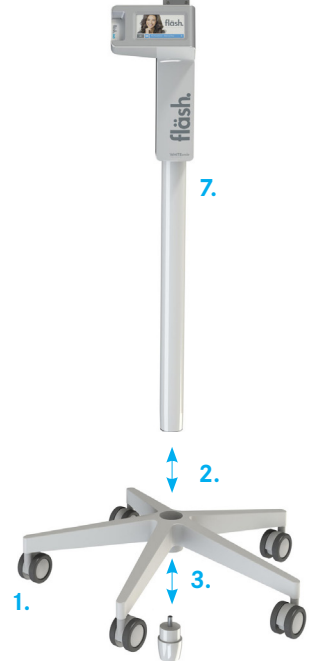

### 3. Technical specifications

fläsch Whitening Lamp is an electronic unit that controls 3 blue LED (Light Emitting Diodes): This unit is used to optimize dental tooth whitening

Technical Information	
Power supply	100-240 V ~ 50 Hz-60 Hz
Max input power	60W
Time-delay fuse	630 mA T
Light spectrum	460 nm
High-intensity lighting source by blue led	max. 190 mW / cm <sup>2</sup> , 3 LED
Protection against electric shock	Class II
Device working and environmental conditions	
Storage Temperature	-20°C to 45°C
Working Temperature	15°C to 30°C

### IMQ and VDE accepted.

Physical Specifications	
Power cord plug	SCHUKO
Power cord length	2,50m
Dimensions	152 × 120 × 63 cm (max. dimensions of build up lamp) 63 × 140 × 63 cm, folded
Total weight	ca. 14 kg



Please refer to the manual!



Medical device CE 93/42: CLASS I



WHITESmile® GmbH  
Weinheimer Straße 6  
69488 Birkenau/Germany  
info@whitesmile.de  
Tel.: +49 (0) 62 01 /8 43 21 90  
MADE IN GERMANY



IP22

100-240 V ~ 50-60 Hz 60W



SN

.....

fläsch Whitening Lamp can be used only with fläsch Light Whitening gels, available in 6 % or 32 % hydrogen peroxide its usage is allowed only in hospital environment, in clinics and in dental studios. It must be used only by experts, qualified for whitening treatments according to the local legal requirements. The manufacturer accepts no responsibility in the event of:

- actions or repair carried out by persons not authorized by the manufacturer or importer.
- use on an electrical system not in conformance with the terms of regulation CEI 64-8.
- a different use from the one specified in this booklet.

<https://stomshop.pro>

## 4. fläshcard time management system



>> Emergency card in case of a card failure. <<

In each fläsh material kit for each patient 60 minutes treatment time are provided. The card can be conveniently placed into the lamp. Remaining time is stored on the card and can be used also on another fläsh Withening Lamp.

SINGLE MODE for single tooth whitening can be used without using the time on the card. Please note that also SINGLE MODE requires a card to be in the slot (even empty cards work.) In the single mode only the middle LED is on – do not use for full whitening sessions – the result will be uneven in front and side.

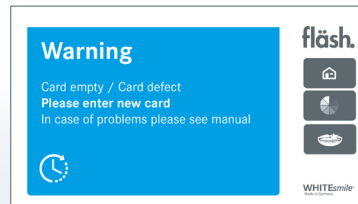
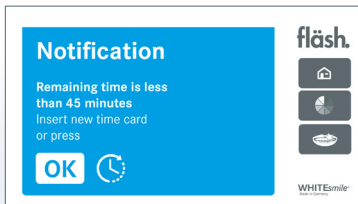

## 5. Easy lift system

The fläsh Whitening Lamp has a unique positioning system. The blue handle (1) releases the lamp to an easy positioning in front of the patient on a 3D level. Once position is found the button is released and the lamp stays put exactly where it should.

**PLEASE NOTE: THE LAMP CANNOT BE MOVED WITHOUT THE BLUE BUTTON!**

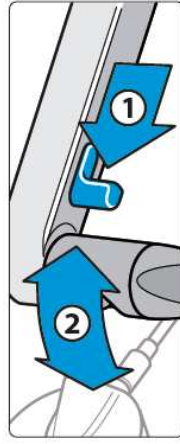
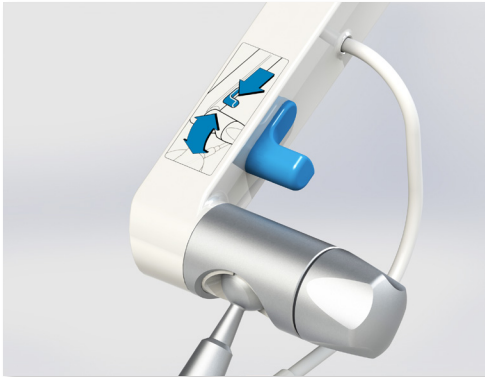

(2) Fine adjustments can be done with the lamp head by loosen and tighten the screw.





## 6. Adjusting lamp/storage

The fläsh Whitening Lamp offers a lot of possibilities to adjust the head of the lamp in front of the patient's mouth. The head can be moved in 3 dimensions. Additionally, the angle of the holding arm of the head can be adjusted.

As shown aside the lamp can be arranged in front of the patient's position, from the side and even from the back.









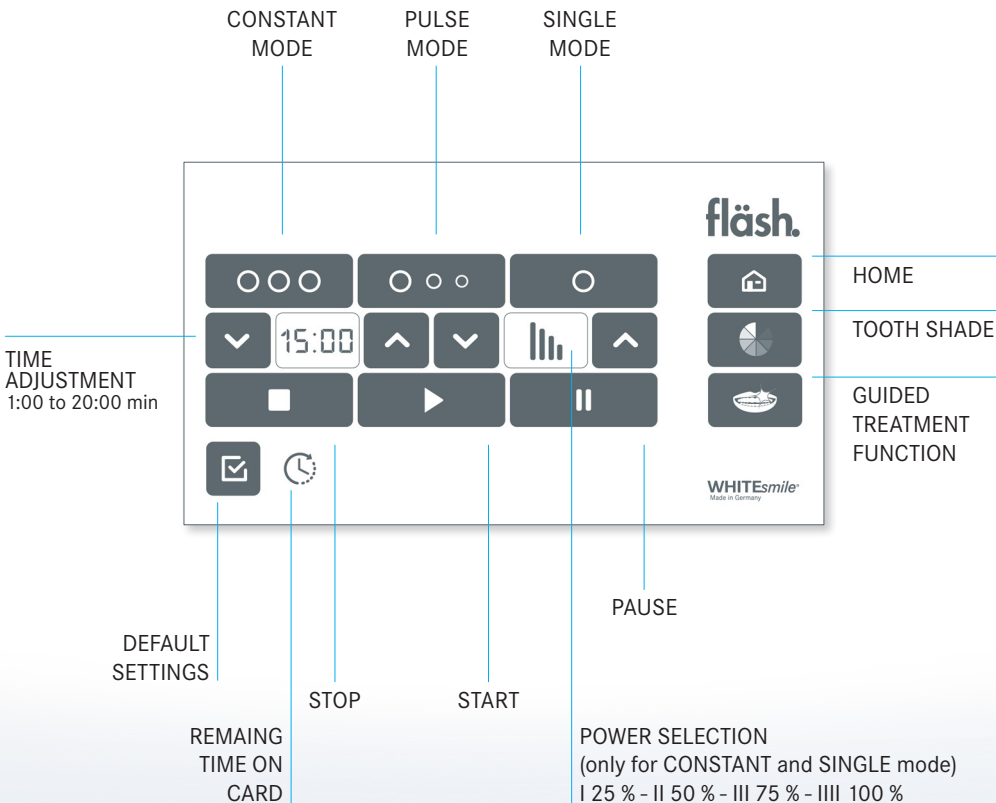



For storage use cable roll-up on back side of the fläsh whitening lamp.



## 7. Operation of user interface

### 7.1 Home screen and functions



	<b>CONSTANT MODE</b>	All 3 LED's are constantly working. Light intensity can be adjusted in 4 levels.
	<b>PULSE MODE</b>	The 3 LED's are activated in a sequence. This mode has a high light intensity with low temperature increase. It is recommended for sensitive patients.
	<b>SINGLE MODE</b>	For single tooth whitening - only middle LED is on. Light intensity can be adjusted in 4 levels. Does not use time credits from the flash card. A card (even empty) must be in the slot to operate. Do not use single mode for full whitening. It will result in an uneven whitening result.
	<b>TIME ADJUSTMENT</b>	Can be adjusted from 1:00 to 20:00 minutes.
	<b>POWER ADJUSTMENT</b>	For CONSTANT and SINGLE mode the light intensity can be adjusted to 25 % / 50 % / 75 % / 100 %. The higher the level the more temperature increase in the gel.
	<b>START</b>	Pressing the "START" button the procedure begins and the LED's go on.
	<b>PAUSE</b>	Pressing the "PAUSE" button holds the process and the time stays on the current value.
	<b>STOP</b>	Pressing the "STOP" button ends the procedure and the lamp jumps back in the original setting.
	<b>TOOTH SHADE</b>	Determines the whitening shade achieved when pre and post treatment shade is entered. Works with classical or bleached guide.
	<b>GUIDED TREATMENT FUNCTION</b>	Allows step by step guided treatments for a perfect result.
	<b>DEFAULT SETTINGS</b>	Allows to preset values for minutes per cycle, power level, kind of shade guide used and language selection.
	<b>REMAINING TIME ON CARD</b>	Shows the remaining time on flashcard. Counts down if PULSE or CONSTANT program are used by the minute. If card is not inserted or empty PULSE or CONSTANT do not work.

## 7.2 Tooth shade achieved determination

Please select the shade guide you want to use in the default settings. You can use the VITA classical shade guide or the VITA Bleached Guide\*. Determine the pre and post treatment shade and select it on the screen. By touching the post treatment shades the fläsh Whitening Lamp immediately shows the achieved tooth shade improvement.

\*Registered trademark Vita Zahnfabrik, Bad Säckingen, Germany.

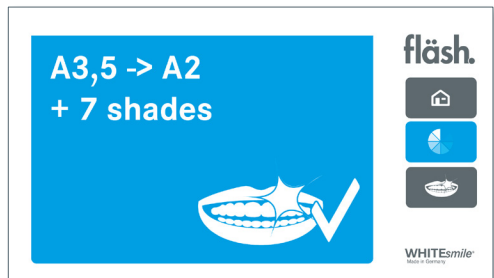
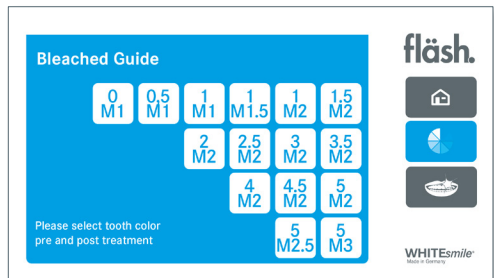
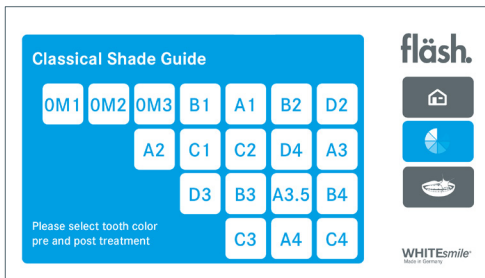

## 7.3 Default settings

The changes in the default settings are stored in the lamp memory until changed again.

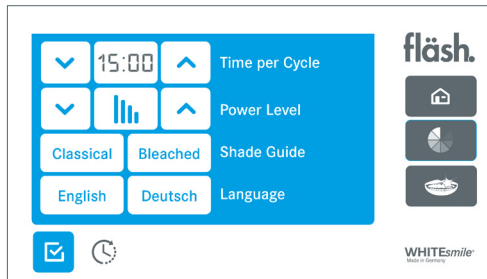

## 7.4 Guided treatment function

The unique guided treatment function allows to go through the whole whitening procedure step by step with illustrated user instructions. It allows a standard procedure every time. The function can be returned to a normal operation by pressing the home button.

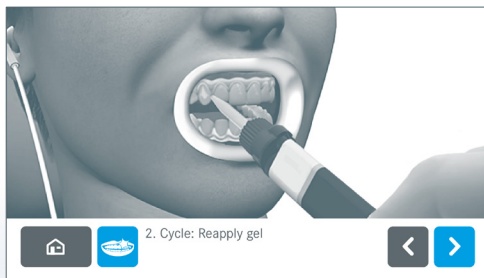
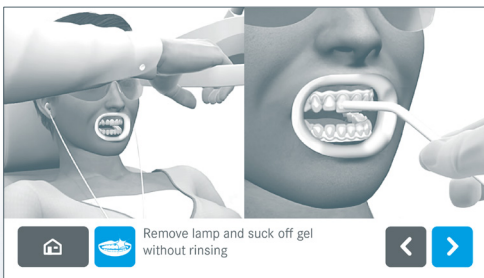
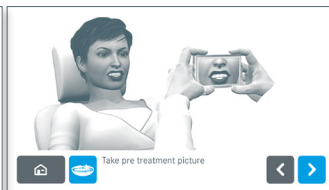
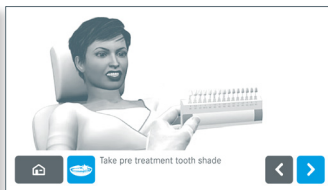
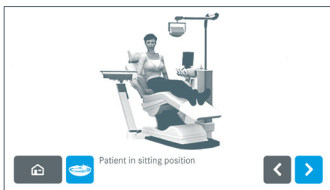
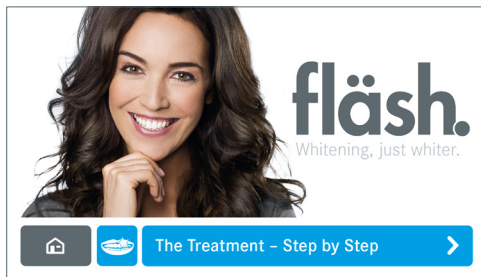

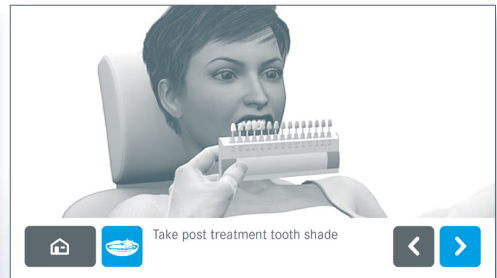
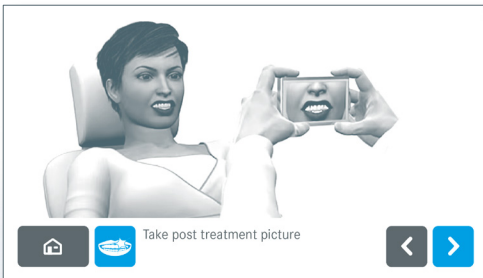
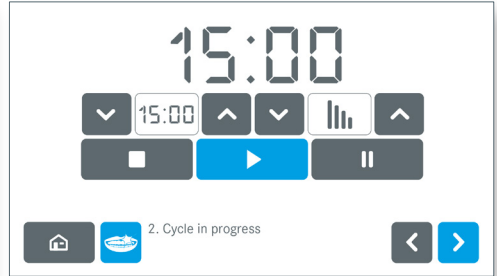
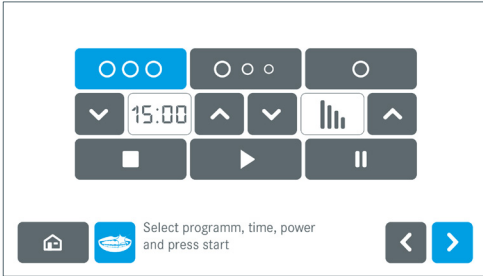

## 8. Whitening procedure – operation of the lamp

**Plug power cable in electrical outlet 100-240 V. Switch on power. See instruction of WHITEsmile gel how to apply the fläsh whitening gel.**

The following special instruction for working in combination with fläsh Whitening Lamp must be followed: All teeth that should not be bleached and are therefore not covered with gel must be covered with moist gauze in order to prevent heating. (to be covered have to be restorations like crowns, bridges, implant suprastructures and veneers or in case of single tooth whitening the other teeth). Gingiva protector can be used for better fixation.



Restorations must be covered with a moist gauze.



At single tooth whitening all other teeth must be covered with moist gauze.



fläsh Light Whitening Gel becomes clear after a few minutes, showing the strong activation of the fläsh Whitening Lamp. The gel is still active and remains on the teeth until the end of the cycle and the lamp goes off.

**Working times of different fläsh gels:**

**fläsh Light Whitening 6 % HP:**  
4 x 15 minutes in one session

.....  
**fläsh Light Whitening 32 % HP:**  
3 x 15 minutes (maximum 4 x 15 minutes)  
in one session

Place lamp in front of the patient slightly touching the lip retractor.



Make sure that patient and operator are wearing orange safety goggles according DIN EN 166:2002-04.



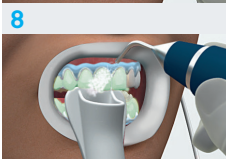
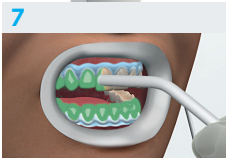
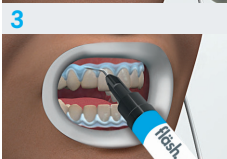

## 9. Power supply / fuse

Double power supply switch with signals „I“ for ON and „0“ for OFF.

100-240 V ~ 50 Hz-60 Hz VDE type float socket.

Double holder for No. 2 time delay fuses with rapid disconnection.

Specifications are marked on close to the power supply control box.

**Control box is located under user interface box.**

## 10. Cleaning

Before cleaning the device, switch it off. The device can be cleaned with a soft cloth slightly moistened with nontoxic and non-flammable solvents: tested solvents available on the market are recommended. Avoid the entry of liquid into device components. Do not use strong solvents or sharp instruments.

## 11. Note

Keep out of children's reach. To be used exclusively as described in this instructions for use. The product may only be used in keeping with the specific instructions for use. WHITESmile does not accept any responsibility for damage resulting from failure to comply with the instructions for use or for uses other than those foreseen by the field of application for the product. The user is responsible for experimenting with the material for uses not explicitly described in the instructions for use.

The descriptions and date reported herein are approximate and not binding. The content of this user's manual is subject to variations.

## 12. Signs and symbols



CE-Symbol



Serial number



See user manual!



Manufacturer



Type B



Switching on/off



Special recycling  
(WEEE)

**REF**

Article number



Protection against  
electric shock class II

**IP22**

IP Protection  
class 22



For indoor use only

## 13. Warranty

WHITEsmile or your local dealer will repair or at its option replace, without charge, your product which proves to be defective in material or workmanship under normal use, during the warranty period of 2 years from invoice date. Freight cost and compensation for absent device are not covered by the warranty. The above warranty does not cover damages or problems which result from misuse, abuse, accident, alteration, or incorrect use not in accordance with the manufacturer's instructions.

WHITEsmile authorizes the repairing of its devices to those laboratories with qualified personnel (electrical engineers) who shall receive the necessary information for repairing and testing the product. The testing equipment and spare parts shall be sent by request. Note: the repairing operation must follow the actual required standards.

In case of breakdown of the apparatus contact your local dealer or:

**WHITEsmile® GmbH**  
**Weinheimer Strasse 6**  
**69488 Birkenau/Germany**

**Phone: +49 (0) 62 01 / 8 43 21-90**

**E-Mail: [contact@whitesmile.de](mailto:contact@whitesmile.de)**

No compensation could be demanded from the purchaser for the detention of the equipment.

# fläsh.

## Whitening Lamp

WHITEsmile GmbH  
Weinheimer Straße 6

69488 Birkenau  
Germany

Phone: +49 (0) 62 01 / 8 43 21-90

Fax: +49 (0) 62 01 / 8 43 21-99

E-Mail: [contact@flaesh.com](mailto:contact@flaesh.com)

© WHITEsmile 2016

Subject to technical changes and errors in the text.

Order-No. 3620 · Version 1.0 · 05/2016

fläsh Whitening Lamp is Made in Germany

**flaesh.com**

<https://stomshop.pro>