

- Plaster model trimmer
HSS-99
with solenoid valve



HSS-99 with inclined support



HSS-99 with orthodontic accessories

● SERVICE MANUAL

Dear customer,

Thank you for choosing a product from the Wassermann range. Wassermann Dental-Maschinen incorporates the highest standards of quality and the latest technology.

In order to enjoy maximum performance and years of trouble-free operation, please read this service manual carefully before you connect this device and start work, and operate the device according to the recommended guidelines. The operation safety and the functionality of this device can only be guaranteed if you follow both the general safety guidelines and the applying laws to prevent accidents as well as the precautions given in this service manual. We are not liable for any damages which occur due to inappropriate usage or faulty operation of this device.



Make sure that anyone using this device has read and understood this service manual.

Keep this service manual in a safe place where it can be referred to as required at any time.

Company address:

Wassermann Dental-Maschinen GmbH

Rudorffweg 15-17

D-21031 Hamburg, Germany

Phone. : +49 (0)40 / 730 926 – 0 Fax.: +49 (0)40 / 730 37 24

E-mail: info@wassermann-dental.com

URL: <http://www.wassermann-dental.com>

Inhaltsverzeichnis

| | |
|-------------------------------------------------|----|
| 1 Features..... | 4 |
| 2 Safety guidelines..... | 4 |
| 2.1 Safety symbols used in this manual..... | 4 |
| 2.2 Safety guidelines..... | 5 |
| 2.3 Potential dangers..... | 5 |
| 2.4 Responsibility for operation or damage..... | 6 |
| 3 Application..... | 6 |
| 4 Before starting..... | 7 |
| 4.1 Transport..... | 7 |
| 4.2 Installation..... | 7 |
| 4.3 Storage..... | 8 |
| 5 Installation / Start-up | 8 |
| 5.1 Location..... | 8 |
| 5.2 Rinsing water hose..... | 8 |
| 5.3 Drain hose..... | 9 |
| 6 Mounting..... | 10 |
| 6.1 Installing the angled mount..... | 10 |
| 7 Setting..... | 10 |
| 8 Operation..... | 11 |
| 8.1 General operating instructions..... | 11 |
| 8.2 Water regulation..... | 11 |
| 9 Troubleshooting..... | 12 |
| 10 Care and maintenance..... | 13 |
| 10.1 Cleaning..... | 13 |
| 10.2 Maintenance..... | 13 |
| 10.3 Repairs..... | 14 |
| 10.4 Spare parts..... | 14 |
| 10.5 Spare grinding discs..... | 14 |
| 10.6 Accessories and spare parts..... | 15 |
| 10.7 Warranty | 15 |
| 11 Technical data..... | 16 |
| 12 EC Conformity Certificate..... | 17 |
| 13 Spare part diagram (164998)..... | 18 |
| 14 Wiring diagram | 21 |

1 Features

- fully diamond-impregnated grinding disc for silky smooth and flat model surfaces
- high grinding speed of 3000 min⁻¹
- extremely powerful, maintenance-free 1200 Watt motor for high efficiency, splash-protected as per IP 54
- optimal water control using ball valve and solenoid valve
- powerful disc and interior rinsing
- adjustable drain supports for easier installation
- extra-large work section of 12.5 x 16 cm
- high-quality, plastic-powder-coated housing
- easy to open using rear handle
- numerous expansion possibilities
- expandable by disc equipment and/or adjustable light for 3 D trimming – ideal for orthodontics
- the grinding attachment KMS can be delivered also on swiss- and EOS-version

2 Safety guidelines

2.1 Safety symbols used in this manual



Warning!

This is a warning of risk situations and dangers.

Failure to observe this warning could be life-threatening. These warnings has to be observed.



Information!

This symbol draws your attention to specific features that has to be observed.

2.2 Safety guidelines

Configuring and operating this equipment requires **precise knowledge** and **observance** of the instructions in this **service manual**. The equipment is designed only for its intended application.



WARNING:

- Servicing and repairs should be carried out only by authorised specialists.
- Before you carry out any cleaning or maintenance work, disconnect the power plug and prevent the motor from restarting accidentally. You should also disconnect the water line.
- Always wear eye protection when working on grinding discs.
- Electric motors have dangerous electrically conducting and rotating parts when in use. They can cause damage to health and property if operated incorrectly, used for other than their intended purpose or inadequately serviced.
- Only qualified specialists should carry out work on the motor.
- Condensers must be allowed to discharge completely before you open the unit.
- When working on the unit, wear close-fitting garments and roll sleeves inwards only. Do not wear gloves.
- If you have long hair, wear some form of protection such as a hair net.
- When working with the HSS-99, do not wear rings, chains, bracelets or similar jewellery.
- Be sure to shut off the tap at night and over the weekend.



Make sure that the equipment is connected to the correct power source.

2.3 Potential dangers



The rotating parts of the trimmer and the grinding blade are dangerous.

2.4 Responsibility for operation or damage

The responsibility for operating the device lies exclusively with the owner or user if said device is incorrectly serviced, maintained or altered by persons not employed by an authorised dealer or if the device is used in a manner contrary to its specified purpose.

The unit has to be maintained and operated in accordance with this service manual. Wassermann Dental-Maschinen GmbH is not responsible for damage arising from the **nonobservance** of these instructions.

Warranty and responsibility provisions contained in the sales and supply conditions of Wassermann Dental-Maschinen GmbH are not extended by these instructions.



Product responsibility lapses if the equipment is altered by third parties or if non-original parts are installed. Use only original Wassermann replacement parts. If damage occurs after a “foreign disc” has been installed, responsibility lies with the person who installed this spare part disc.

If diamond-grinding discs are used, they will exhibit extreme wear if you grind embedding materials and metals. Wassermann assumes no responsibility in such cases.

3 Application

The HSS-99 plaster model trimmer is used in dental laboratories and is designed only for grinding (trimming) plaster models.

To prevent damage to the trimmer and/or to the grinding disc, it has to be used only with plaster. Otherwise, the grinding disc will quickly lose its sharpness and cutting speed.

Only use the device for this type of application.

4 Before starting

4.1 Transport

Before transporting the unit, ensure that it has been unplugged from the power socket. Make sure that it is packed correctly in order to avoid accidental damage.

 Be sure to check for any transport damage when unpacking the goods. Note down any damage if found.

4.2 Installation

Open the box, remove the packing materials, and carefully lift out the device and accessories. Check the included accessories.

The device has to stand horizontally on a steady and even surface.

 Install the device in a place where it will not block the working area and the functionality (take the dimensions into account). When you set up the unit, make sure that the grinding disc is accessible and that the unit is close to the plaster separator.

You will need the thinner pressure hose (½ inch – 13 mm) with the woven insert when installing the **rinsing water** hose. You use the thicker plastic hose (1 inch – 25 mm) for the **drain hose**. When installing the drain hose, make sure that the hose end hangs freely in the separator and not beneath the surface of the water.

 Do not install the unit outdoors or in places without proper ventilation.

Before start-up, be sure the device reaches room temperature.

4.3 Storage

When it comes to functional safety, the location of the trimmer is very important, even if it is only to be stored there for a short period. The location should be dry, well ventilated and free of vibration. An even temperature and a wooden base are desirable. Do not set up or store the trimmer outdoors. If the unit is to be stored for an extended period, protect it from moisture and dust.

5 Installation / Start-up

5.1 Location

Because the trimmer operates only with water, we recommend you install it close to a tap. The best place is right next to a washbasin or, using the wall mount, directly above the basin. A further variation is to set up the trimmer on a console in the basin itself.



Before starting the unit, connect up the following:

5.2 Rinsing water hose

Locate the ***rinsing water hose*** (thinner hose with woven insert) between the tap and the hose connector on the trimmer. This connector is underneath the unit. Lay it on its side to connect the hose, making sure not to damage the paint. Use the clamps already on the hose to connect it, tightening them securely.

There should be a stopcock between the tap and the feed hose so the hose is not under continuous pressure when the trimmer is not being used.



Tighten the hose clamps again about 2 days after installation.

The tap has to be turned off at night and over the weekend.

5.3 Drain hose

The drain hose must be laid out such that water can never back up in the trimmer. This would cause the water to spray out through the grinding disc opening. Always arrange the hose in a smooth bend (not kinked) and with a permanent drop of at least 2 cm per metre.



**The end of the drain hose must be above the water level of a plaster catcher.
The hose end must not be immersed in water.**

If necessary, shorten the hose or change the drain angle at the trimmer end by turning the drain-hose connection.

In its standard configuration, the drain-hose connection is *angled* off to the right. However, it can also be aligned *vertically* to the right, and this is recommended in difficult drain situations.

In that case, use a sealing cap instead of the drain connection.

Finally, insert the power plug into the socket, making sure that the mains and the unit operate on the same voltage.

6 Mounting

6.1 Installing the angled mount

The angled mount is used for trimming very protruding teeth so as not to cut the teeth off. The angled mount is attached to the HSS-99 support plate. Please follow the guidelines below.

 **When working with the angled mount, make sure that it has been installed correctly. It should be installed as shown in the diagram below.**

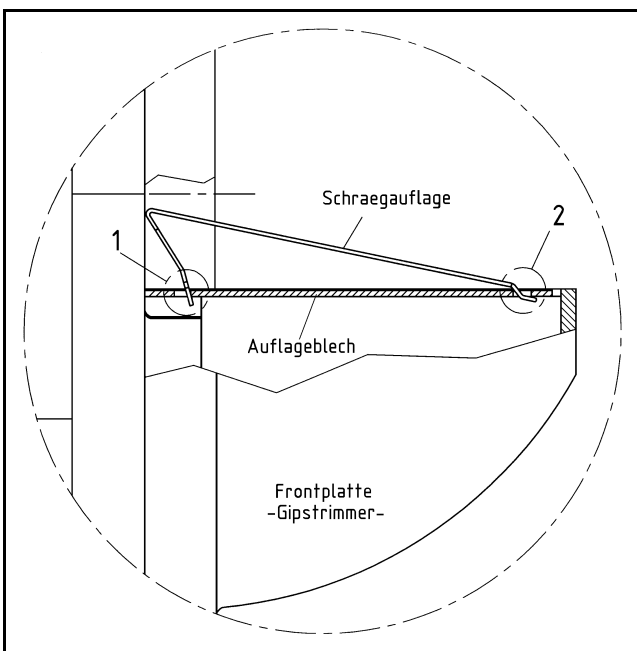

Make sure that items 1 and 2 are inserted and engaged correctly in the support plate.

7 Setting

The HSS-99 plaster trimmer does not need any other support than the one described in 6.1 “Installing the angled mount”.

8 Operation

8.1 General operating instructions

All instructions for using the unit, whether in verbal or written form, are based on our own experience and experimentation and can only be regarded as guidelines.

-  After you switch the trimmer on, wait a few seconds for the motor to come up to speed. Only then can you use its full power.
Never push on the models so hard that the motor labours. This could overload it and cause possible damage.

8.2 Water regulation

The water supply can be regulated using the tap or the red ball valve. If you intend to set it using the ball valve, make sure the tap is fully open. Whichever method you use, the flow of water is sufficient if the grinding disc is close to its natural colour when grinding.

The grinding itself is done by applying light pressure and small left / right movements of the model.

-  Always work with fully set plaster models because wet plaster can block drain hoses and cause “smearing” of the grinding disc.

9 Troubleshooting

| Fault | Cause | Remedy |
|-----------------------------|-------------------------------------------------------------------|-----------------------------------------------------------------------|
| Water spray at disc opening | Water supply set too high | Reduce water pressure at tap or ball valve (see 8.2 Water regulation) |
| | Drain hose has been lengthened with a thinner hose | Make sure that the diameter of the drain hose is 1 inch (25.4 mm) |
| | Drain hose is kinked | Make sure the hose is laid out without kinks |
| | Hose end is under the surface of the water in the plaster catcher | Make sure the hose ends above the water surface |
| | The fall of the hose is insufficient | Ensure that the fall is at least 2 cm per metre |
| | The radius of the hose is too small | Ensure that the hose is laid out as straight as possible |
| | There is a tube bend in the hose (causing blow-back) | The bend must be increased to at least $\varnothing = 40$ mm |



If the above recommendations do not solve the problem, contact your dental depot or our service department.

10 Care and maintenance

10.1 Cleaning



Before you carry out any cleaning or maintenance work, disconnect the power plug and prevent the motor from restarting accidentally.

Be sure to disconnect the water supply when carrying out this work.

Do not open the unit until the grinding disc has come to a complete stop.

The identification plate has always to be kept in easily legible condition and has not to be removed.



Remove external dirt (caustic traces of plaster) from time to time with some form of cold cleaner.

Use only cold cleaners to avoid damaging the paintwork or removing the lettering.

The equipment should be cleaned at regular intervals to ensure trouble-free operation.

It requires only normal cleaning (sponge, damp cloth, mild detergent) and no further chemical additives.

10.2 Maintenance

The HSS-99 plaster model trimmer does not require any maintenance. However, if you open the disc chamber for cleaning or to change the disc, be sure to clean the sealing surfaces and coat them with a new application of water-insoluble grease.

For safety reasons, you should regularly check that the clamps on the water hose are tight.

10.3 Repairs



Servicing or repairs to the unit has only to be carried out by qualified technicians. Only original spare parts are to be used. Responsibility for the product is voided if unauthorised persons alter it or if inappropriate components are installed.

10.4 Spare parts

If necessary please contact our service hotline phone:
0049 (0)40 / 730 92 6-0

10.5 Spare grinding discs

Grinding discs are always supplied with a tube of grease for sealing the grinding chamber. An extractor is also provided for removing the old disc.



We strongly advise against installing a grinding disc on top of an already installed disc, regardless of its origin and type.



Warning!

If diamond discs are used, you will experience extreme disc wear when grinding embedding materials and metals. We assume no responsibility for this.



When using a spare grinding disc, follow the instructions provided for changing discs.

10.6 Accessories and spare parts

| Incl. in delivery | Item no.: |
|--------------------|-----------|
| Inclined support | 164037 |
| Supply hose 1 m | 320006 |
| Discharge hose 1 m | 320017 |

| Accessories | Item no.: |
|----------------------------------------------------------|-----------|
| Spare diamond grinding disc, including puller and grease | 164063 |
| Grinding device KMS according to B. E. G. G. | 164080 |
| Directional light GTE | 164081 |
| Template for upper jaw to trim the lower jaw tube level | 168082 |
| Sealing grease for trimmer, 25 ml | 629002 |
| Puller for grinding disc change | 164026 |

10.7 Warranty

 The warranty period for our equipment is 12 months. If faults occur within the warranty period, contact your dental depot or get in touch directly with our service department.

Your equipment should only be operated in perfect condition. If faults occur which could harm operators or third parties, the unit should not be used until it has been fixed.

This warranty does not cover damage caused by improper use, external mechanical causes, transport damage or interference with the unit by unauthorized persons.

11 Technical data

| | |
|-------------------------------------|-------------------------|
| HSS-99 without grinding disc | Item no.: 164999 |
| Voltage* | 220–240 V / 50/60 Hz |
| Power consumption | 5.5 A |
| Output | 1200 W |
| W x H x D | 400 x 430 x 470 mm |
| Weight | 33.0 kg |
| Sound level | 65 dB (A) |
| Speed | 3000 min ⁻¹ |
| Duty | S6-40 % |
| Table dimensions projecting | 160 mm |

The noise emission measured in a 1-metre circle around the unit and 1.6 metres high at an average 50% idling, 30% average load and 20% full load was 65 dB(A). This was determined in accordance with DIN 45635 Part 1.

*Other voltages on request.



The technical data are subject to change without prior notice.

12 EC Conformity Certificate

in accordance with 2006/95/EG (low-voltage guidelines) and 2004/108/EG (EMV guidelines) and 2006/42/EG (machinery guidelines)

Manufacturer: W A S S E R M A N N Product description: Plaster model
Dental-Maschinen GmbH trimmer for dental
Rudorffweg 15 - 17 applications
D-21031 Hamburg

Model: HSS-99 plaster trimmer with diamond grinding disc Item no. 164998
HSS-99 plaster trimmer without grinding disc Item no. 164999

Applicable standards: DIN EN 61010-1
DIN EN 61000-6-3
DIN EN 61000-6-1
DIN 45635-1
DIN EN 60335-1

Hiermit wird bestätigt, dass die oben bezeichnete Maschine den genannten EG-Richtlinien entspricht. Diese Erklärung wird ungültig, falls die Maschine ohne unsere Zustimmung verändert wird.

This is to confirm that the above mentioned machine complies with the described EC rules. This declaration becomes invalid if the machine is modified without our approval.

Cette machine est conforme aux normes en vigueur de la Communauté Européenne. Cet avis est nul et non avenant si cette machine est modifiée sans notre accord.

Esta máquina, anteriormente mencionada, cumple con los límites requeridos por el reglamento EC. Ahora bien, esta declaración quedará invalidada en caso de realizar modificaciones al aparato sin nuestra aprobación.

Hiermee wordt bevestigd dat bovengenoemde machine voldoet aan de voorgeschreven EU normen. Deze verklaring verliest geldigheid als er zonder onze uitdrukkelijke toestemming wijzigen aan de machine worden aangebracht.

Place, date: Hamburg, 02.11.2012

Company stamp:



WASSERMANN
DENTAL-MASCHINEN GMBH
Rudorffweg 15-17 · 21031 Hamburg

Signature : _____
Wilfried Wassermann
(Managing Director)

13 Spare part diagram (164998)

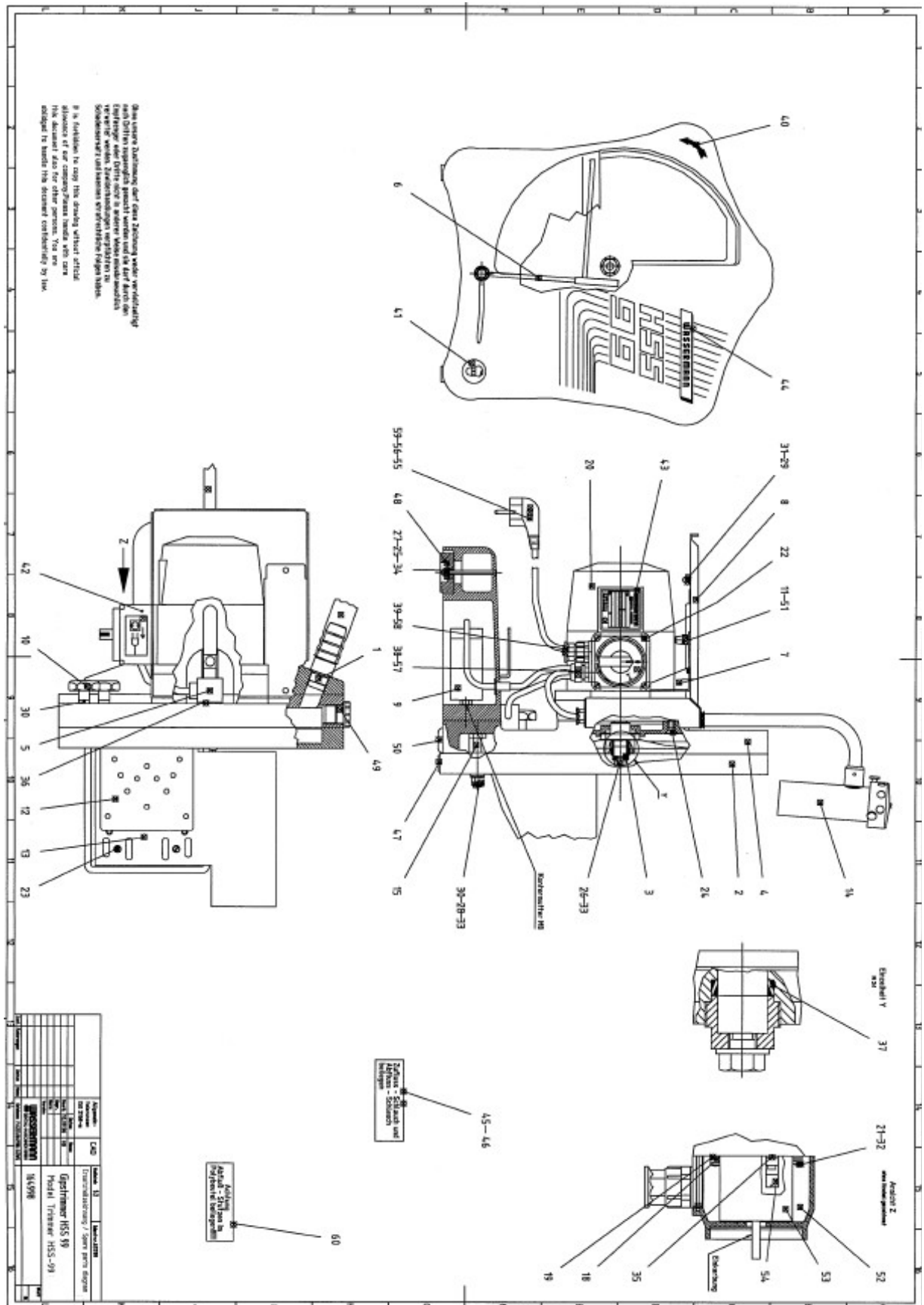



| Menge | Beschreibung | Lfd. Nr. | Material | Zeichn.Nr. |
|-------|---------------------------------|----------|----------|------------|
| 1 | Drain for HSS | 1 | | 160014 |
| 1 | Front plate | 2 | | 164002 |
| 1 | Compression bushing | 3 | | 164005 |
| 1 | Bearing assambled | 4 | | 164011 |
| 1 | Solenoid valve cpl. | 5 | | 164013 |
| 1 | Spraying system cpl. | 6 | | 164015 |
| 1 | Tray angle | 7 | | 164023 |
| 1 | Tray | 8 | | 164024 |
| 1 | Capacitor 12 μ F assambled | 9 | | 164028 |
| 4 | Star handle | 10 | | 164033 |
| 1 | Tray support | 11 | | 164036 |
| 1 | Inclined bearing table | 12 | | 164037 |
| 1 | Grinding attachment KMS | 13 | | 164080 |
| 1 | Range illumination fittings GTE | 14 | | 164081 |
| 1 | Stud bolt -new- | 15 | | 168057 |
| 1 | Position indicator 0-I | 16 | | 168107 |
| 1 | Cable feedtrough | 17 | | 168108 |
| 2 | Clamping plate | 18 | | 168109 |
| 2 | Shim | 19 | | 168110 |
| 1 | Motor with housing | 20 | | 168520 |
| 4 | Srew DIN 7985 M3x8 | 21 | St Zn | 200005 |
| 4 | Srew DIN 84 M4x45 | 22 | VA | 200070 |
| 4 | Srew DIN 963 M4x8 | 23 | VA | 201009 |
| 4 | Srew DIN 963 M8x25 | 24 | VA | 201019 |
| 2 | Srew DIN 964 M5x60 | 25 | Ms Ni | 201056 |
| 1 | Srew DIN 933 M8x25 | 26 | VA | 201103 |
| 2 | Nut DIN 934 M5 | 27 | VA | 202002 |
| 1 | Cap nut DIN 917 M8 | 28 | Ms Cr | 202101 |
| 4 | Cap nut DIN 1587 M4 | 29 | VA | 202111 |
| 5 | Washer D8,4 | 30 | PVC | 204001 |
| 4 | Washer DIN 125 A4,3 | 31 | VA | 204004 |
| 4 | Washer DIN 6798 A3,2 | 32 | St Cr | 204009 |
| 2 | Washer DIN 125 D8,4 | 33 | VA | 204014 |
| 2 | Washer DIN 9021 D5,3 | 34 | VA | 204019 |
| 1 | Washer DIN 6798 J4,3 | 35 | VA | 204037 |
| 1 | Aluminium seal DIN 7603 A-D16 | 36 | | 205205 |
| 1 | Clamping piece 16x20 RFN 8006 | 37 | | 235001 |
| 1 | Gasket Pg 11 | 38 | | 304210 |
| 1 | Gasket Pg 13,5 | 39 | | 304211 |
| 1 | Rotational direction arrow left | 40 | | 310003 |
| 1 | Sticker "wear goggles" black | 41 | | 310004 |
| 1 | Sticker "Disconnect power play" | 42 | | 310009 |
| 1 | Type plate foil 52 x 52 neutral | 43 | | 310035 |
| 1 | Logo | 44 | | 310070 |
| 1 | 1m water supply hose 1/2" | 45 | | 320006 |
| 1 | 1m drainage hose 1" | 46 | | 320017 |
| 2 | Rubber foot D20 - H5 - black | 47 | | 392004 |
| 2 | Rubber foot D52 - H19 | 48 | | 392005 |
| 1 | Screw plug M24 x 1,5 - black | 49 | | 392007 |

| Menge | Beschreibung | Lfd. Nr. | Material | Zeichn.Nr. |
|-------|----------------------------------|----------|----------|------------|
| 2 | Rubber foot 32 x 32 - H6 black | 50 | | 392008 |
| 1 | Rubber damper D8 - H1,6 | 51 | | 392026 |
| 1 | Switch cap HSS-88/HSS-AZ | 52 | | 510050 |
| 1 | Switch for HSS with toggle | 53 | | 511110 |
| 1 | Grounding terminal | 54 | | 580004 |
| 1 | Cable end sleeve | 55 | | 581039 |
| 2 | Cable end sleeve black insulated | 56 | | 581052 |
| 1 | Cable Screw connection | 57 | | 584001 |
| 1 | Cable Screw connection | 58 | | 584010 |
| 1 | Plastic patch cord | 59 | | 592009 |
| 1 | Poly-bag | 60 | | 671005 |
| 1 | Packing | 61 | | 673066 |

14 Wiring diagram

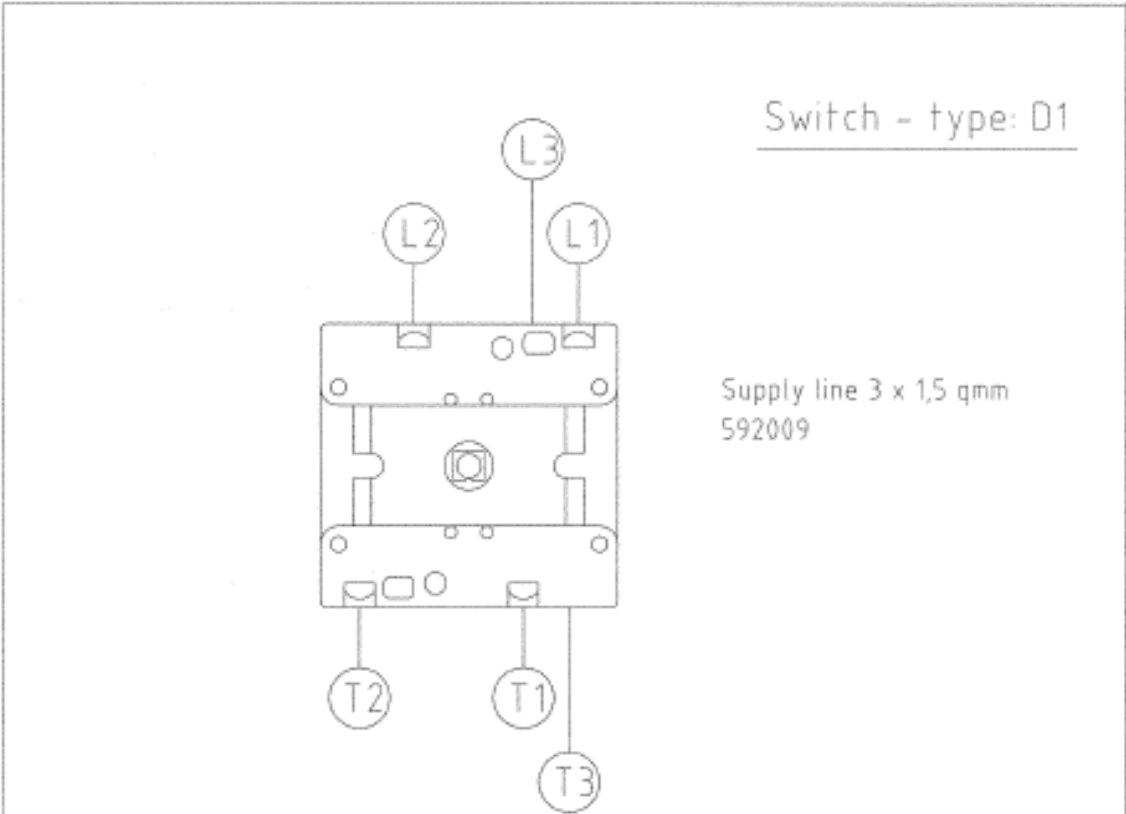

In case of assembling an adjustable light (only HSS-99/HSS-88) please connect same-coloured strands (solenoid valve/transformer) with cable en sleeve (blue insulated)

- L1 = Supply line brown
- L2 = Supply line blue + solenoid valve blue -----transformer blue
- L3 = Condenser brown
- T1 = Z1 + U2 + solenoid valve brown -----transformer brown
- T2 = U1 + condenser blue
- T3 = Z2

| | | | | | | | |
|-------|------------------|----------|------|---------------------------------------------------------------------------------------------------------|--------|---------|----------------------------------------------------------------------------------------|
| | | | | Allgemein- toleranzen DIN 7168-m | CAD | Maßstab | ID.NR. |
| | | | | 94 | Datum | Name | Terminal connection diagramm for switch with solenoid valve HSS-99/HSS-88/HSS-AZ |
| | | | | Bearb. | 01.07. | KRD | |
| | | | | Gepr. | | | |
| | | | | Norm | | | |
| | | | | Verstärk. | 2 | TH | |
| x | Zg. aktualisiert | 22.01.99 | KR |  zg\HSS88-2__engl | | | Blatt |
| | Äend. storniert | 13.01.97 | HB | | | | 01. |
| | Anschluss geaen. | 18.12.96 | HB | | | | |
| Zust. | Änderung | Datum | Name | | | | |

Notes:



WASSERMANN
DENTAL-MASCHINEN

● Die Basis für Ihr Labor

Wassermann Dental-Maschinen GmbH
Rudorffweg 15-17 · D-21031 Hamburg
Tel.: +49 (0)40 730 926-0 · Fax: +49 (0)40 730 37 24
info@wassermann-dental.com

www.wassermann-dental.com

<https://stomshop.pro>