

# Instructions for Use



RIK-1 - ENG - Rev03

<https://stomshop.pro/>

lina

RIK-117 RIK-122

<https://stomshop.pro/>

# Table of contents

Conformity .....	5	Printer selection (optional) .....	33
Symbols and messages .....	6	Label printer selection (optional) .....	33
<b>Introduction .....</b>	<b>7</b>	Label printer usage (optional) .....	34
About this manual .....	7	Label content description .....	36
Use restrictions .....	8	<b>Sterilizer tests .....</b>	<b>37</b>
<b>Safety information .....</b>	<b>9</b>	Sterilizer performance tests .....	37
Safety warnings .....	9	Bowie and Dick test .....	37
Responsibility .....	10	Helix test .....	40
<b>Getting started .....</b>	<b>11</b>	Vacuum test .....	42
Unpacking .....	11	<b>Sterilization cycles .....</b>	<b>44</b>
Handling .....	13	Load maintenance and preparation .....	44
Product description .....	14	Prepare the sterilizer .....	46
Installing the sterilizer .....	18	Sterilization cycle description .....	47
Operating the sterilizer .....	20	Sterilization cycle management .....	48
User interface menu .....	21	Unloading .....	52
Sterilizer setup .....	27	Sterilization cycle report .....	52
User authentication (optional) .....	28	<b>Maintenance .....</b>	<b>57</b>
USB pen drive .....	29	Warnings for maintenance operations .....	57
Standby mode .....	29	Ordinary maintenance .....	57
<b>Administrator .....</b>	<b>31</b>	Monthly or 50-cycle maintenance .....	59
User management (optional) .....	31	400-cycle maintenance .....	64
Traceability options (optional) .....	32	800-cycle or biannual maintenance .....	66
<b>Managing printers .....</b>	<b>33</b>	800-cycle maintenance .....	72



---

4000 cycle or five-year maintenance .....	74
Extraordinary maintenance .....	75
Disposal .....	76
<b>Diagnostics .....</b>	<b>77</b>
Errors .....	77
Troubleshooting .....	82
Emergency door opening .....	88
<b>Technical data .....</b>	<b>91</b>
Sterilization cycles .....	91
Sterilization cycle phases .....	95
Technical data .....	98
Recommendations for validation .....	100
Diagrams .....	101
Water quality .....	102
Accessories, spare parts, consumables .....	103
Authorized W&H service partners .....	109
<b>Documentation forms .....</b>	<b>110</b>
W&H installation check-list .....	110
Helix test documentation form .....	112

# Conformity

## CONFORMITY TO EUROPEAN STANDARDS AND DIRECTIVES

STERILIZER featuring sterilization cycles conform with the following standards:

Standards and Directives	Description
 <sup>0051</sup> 93/42/EEC	Medical Device Directive (MDD). Medical Device Directive 93/42/EEC for devices class IIb, in accordance with the Rule 15 – ANNEX IX of the above Directive.
 <sup>0497</sup> 2014/68/EU	Pressure Equipment Directive (PED). Directive 2014/68/EU (PED – Pressure Equipment Directive) for every sterilization chamber designed and manufactured in conformity to the ANNEX 1 and to the procedure described in the module D1 Annex III.
2012/19/EU	Waste Electrical and Electronic Equipment (WEEE).
EN 13060	Small steam sterilizers.
IEC 61010-1	Safety requirements for electrical equipment for measurement, control and laboratory use, general requirements.
IEC 61010-2-040	Safety requirements for electrical equipment for measurement, control and laboratory use; particular requirements for sterilizers and washer-disinfectors used to treat medical materials.
IEC 61326-1	Electrical equipment for measurement, control and laboratory use - EMC requirements; general requirements.
IEC 61770	Electric appliances connected to the water mains - Avoidance of backsiphonage and failure of hose-sets.

**Note:** LINA sterilizers can be validated in accordance to EN17665-1.

**Note:** Every new sterilizer is delivered with a Declaration of Conformity and a Warranty Card.

# Symbols and messages

## SAFETY SYMBOLS USED IN THIS MANUAL



**WARNING:** Indicates a hazardous situation that, if not avoided, could result in death or serious injury.

Related to a sterilizer, these warnings indicate hazardous situations that could result in non-sterile conditions (e.g. non-sterile instruments) which could lead to fatal personal injury.



**CAUTION:** Indicates a hazardous situation that, if not avoided, could result in minor or moderate injury.

## SYMBOLS DISPLAYED ON THE PRODUCT



Hot surfaces!  
Risk of burns.



Hot steam!  
Risk of burns.



Consult the  
Instructions for Use  
for important  
cautionary  
information.



Don't use drinking  
water to fill the clean  
water tank; use only  
distilled or  
demineralized water.



Consult the  
Instructions for Use.



Do not dispose of with  
normal waste

## PROPERTY DAMAGE MESSAGES

**Notice:** Indicates information considered important, but not hazard-related. Typically to avoid damage to the product.

# Introduction

## CONTENTS

This section deals with the following subjects:

About this manual .....	7
Use restrictions .....	8

## About this manual

### INTRODUCTION

This manual contains the Instructions for Use of the W&H sterilizers RIK-117 and RIK-122, hereinafter referred to as LINA 17 and LINA 22.

### FOR YOUR SAFETY AND THE SAFETY OF YOUR PATIENTS

The purpose of this manual is to provide information about LINA sterilizers to ensure:

- proper installation and set-up;
- optimal use;
- safe and reliable operation;
- compliance with regular maintenance and servicing requirements

Please carefully read the safety information (see "Safety warnings" on page 9).

### OBLIGATIONS WITH REGARD TO THIS MANUAL

This manual is an integral part of the product and accompanies it for its entire working life. It must be consulted in all situations related to the life cycle of the product, from its delivery through to decommissioning. For this reason, it should always be accessible to operators both online and offline.

Contact customer service in the event the manual is unavailable. If the device is transferred, always attach the manual for the new owner.

### MANUAL CONTENT

This manual contains the Instructions for Use and for maintenance of the following sterilizer versions:

- RIK-117
- RIK-122

Versions differ only for the chamber volume.

### DISCLAIMER

All pictures, graphics and illustrations provided in this manual are for the comprehension of the text. They are not meant to be an accurate representation of product details. Thus, they should be taken as indicative only, and may differ from the actual product.

For any suggestions or remarks please send an email to [office.sterilization@wh.com](mailto:office.sterilization@wh.com).

## COPYRIGHT NOTICE

Copyright © 2020, W&H Sterilization Srl

All rights reserved in all countries.

All drawings, images and texts contained in this manual are the property of the manufacturer. Even partial duplication of drawings, images or text is prohibited.

The information contained in this document is subject to change without prior notice.

## Use restrictions

### INTENDED USE

The small steam sterilizers are intended for sterilization in medical field e.g. in general medical practice, dentistry, podiatry, facilities for personal hygiene and beauty care and also veterinary practice. They are also intended to be used for materials and equipment which are likely to come into contact with blood or bodily fluids, e.g. implements used by beauty therapists, tattooists, body piercers and hairdressers.

The devices are intended for professional use only by trained people.

### PROVIDED FEATURES

See "Sterilization cycles" on page 91 for the full list of key program features, including sterilization time, temperature and recommended load type.

## USER QUALIFICATION

The users who may operate the sterilizer are the following.

User qualification	Competences
Head of the clinic/practice	Legally responsible for: <ul style="list-style-type: none"> <li>■ the efficiency of the hygiene protocol in place</li> <li>■ the sterilization process</li> <li>■ the operators' training and training documentation</li> <li>■ the correct operation and maintenance of the equipment</li> </ul>
Trained operators	<ul style="list-style-type: none"> <li>■ Regularly attend the training for operating and using the sterilizer safely.</li> <li>■ Use the sterilizer according to the Head of the clinic/practice's instructions.</li> </ul>



# Safety information

## CONTENTS

This section deals with the following subjects:

Safety warnings .....	9
Responsibility .....	10

## Safety warnings

### THERMAL HAZARDS



- The chamber automatically begins to heat to high temperature as soon as the sterilizer is switched on – risk of burns!
- The trays and the sterilization load are hot at the end of each cycle. Use tray or cassette holders to empty the sterilization chamber.
- Always wear appropriate PPE during use of the sterilizer (e.g. gloves for cleaning, maintenance, etc...).

### ELECTRICAL RISKS



- Do not pour water or any other liquids over the sterilizer (risk of electrical short circuits).
- Switch off the sterilizer and unplug the mains cable before inspecting, carrying out maintenance or servicing the sterilizer.
- Ensure that the power receptacle the sterilizer is connected to is properly grounded.
- All electric devices connected to the sterilizer shall be of Insulation Class II (double insulated) or higher.
- Use only the power cord provided by the manufacturer.

### IMPROPER USE OF THE STERILIZER



- The sterilizer must not be used in presence of explosive or flammable gases, vapors, liquids or solids.
- The sterilizer has not been designed for the sterilization of foodstuff or waste.
- Do not exceed the maximum load weight limits as specified in this manual (see "Sterilization cycle management" on page 48).
- Do not drink any water that has been inside the sterilizer.

## TAMPERING



- Do not remove the name plate or labels from the sterilizer.
- Repairs, maintenance or service must be carried out by authorized service providers always using genuine spare parts.

## REQUIREMENTS



- Use only the power cord set and accessories provided by the manufacturer.
- In case of malfunction of the sterilizer, contact an authorized technician or the manufacturer.

## CYBER SECURITY

In order to improve the IT security of the system, a firewall (iptables) is installed in the system and protects the security of the device from external attacks.

It is recommended not to leave the machine unattended.

**Note:** a list of security information is mentioned in the MDS2 document, which is available on request.

# Responsibility

## USER RESPONSIBILITY

- The user is responsible for the proper installation, the correct use and maintenance of the sterilizer in accordance with these Instructions for Use.
- The safety devices of the sterilizer are impaired when the product itself is not installed, used and serviced in accordance with these Instructions for Use.
- The Instructions for Use updated to the latest version is always available at [www.wh.com](http://www.wh.com).
- Keep these Instructions for Use for future reference.

## MANUFACTURER RESPONSIBILITY

- The manufacturer can only accept responsibility for the safety, reliability and performance of the product when the product itself is installed, used and serviced in accordance with the Instructions for Use.
- Servicing by unauthorized persons invalidates all claims under warranty and any other claims.

# Getting started

## CONTENTS

This section deals with the following subjects:

Unpacking .....	11
Handling .....	13
Product description .....	14
Installing the sterilizer .....	18
Operating the sterilizer .....	20
User interface menu .....	21
Sterilizer setup .....	27
User authentication (optional) .....	28
USB pen drive .....	29
Standby mode .....	29

## Unpacking

### UNPACK THE STERILIZER



**CAUTION!** Heavy product. The sterilizer must be removed from the box and transported by two authorized technicians.

Weight:

- LINA 17: 41.5 kg (91.5 lbs)
- LINA 22: 43.5 kg (95.9 lbs)

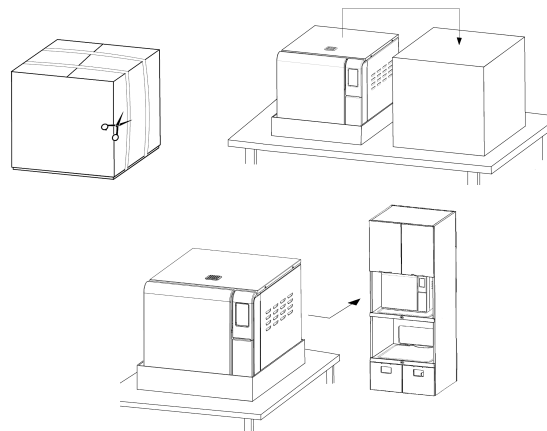

## WARNINGS

**Notice:** Check the external condition of the box and the sterilizer. In case of any damage, immediately contact the dealer or shipping agent that has carried out the transport. Keep the packaging for shipping or transporting the sterilizer in the future.

**Note:** The packaging of the product is environmentally friendly and can be disposed of by industrial recycling companies.

## CONTENTS OF THE PACKAGING

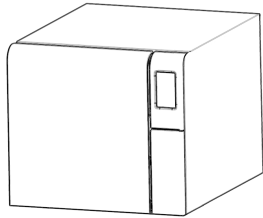

Sterilizer

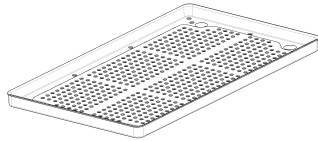

Trays (three)

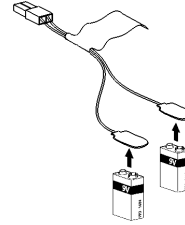

Emergency door opening tool

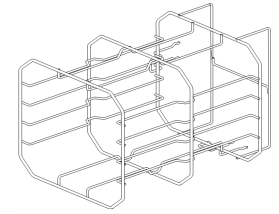

Reversible rack

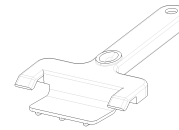

Tray holder

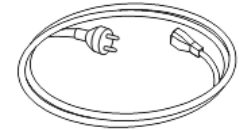

Mains cable

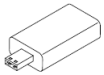
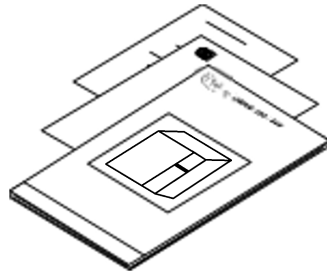

Drain tube

Tube for drain connection  
(available only for LINA AWF  
version)USB pen drive loaded with  
Instructions for UseThis manual, declaration of  
conformity, warranty card, work  
test report, maintenance sheet

## ITEMS NOT PROVIDED WITH THE STERILIZER

The following items are not provided:

- Water container to capture waste water during manual tank draining (volume larger than 5 l (1.3 gal))
- LAN cable for connecting the sterilizer to a network (optional)

See "Accessories, spare parts, consumables" on page 103 for a full list of optional accessories.

## Handling

### HOW TO RELOCATE THE STERILIZER

Before transport:

- Completely drain both water tanks (see "Draining the used and clean water tank" on page 75).
- Allow the sterilization chamber to cool down.
- Use original packaging when shipping or transporting the sterilizer. Replacement packaging materials are available from Service W&H.

## Product description

### FRONT VIEW AND UPPER INTERNAL STRUCTURE

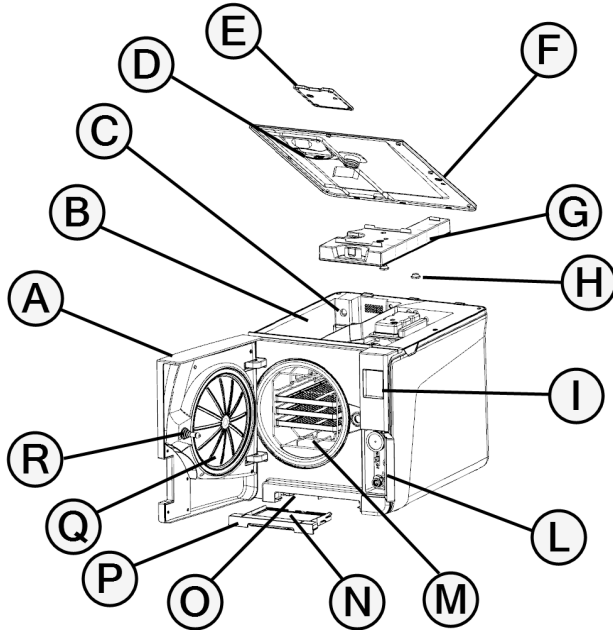

Part	Description
A	Chamber door
B	Tank
C	Water level sensor
D	Water tank cover
E	Tank filling cover-cap
F	Water tank cover
G	Internal tank cover
H	Tank internal filters with metal cartridges
I	Touch screen
L	Service door
M	Sterilization chamber
N	Dust filter
O	Reset button of the thermostat switch
P	Emergency door opening tool
Q	Door seal
R	Door pin

## COMPONENTS BEHIND THE SERVICE DOOR

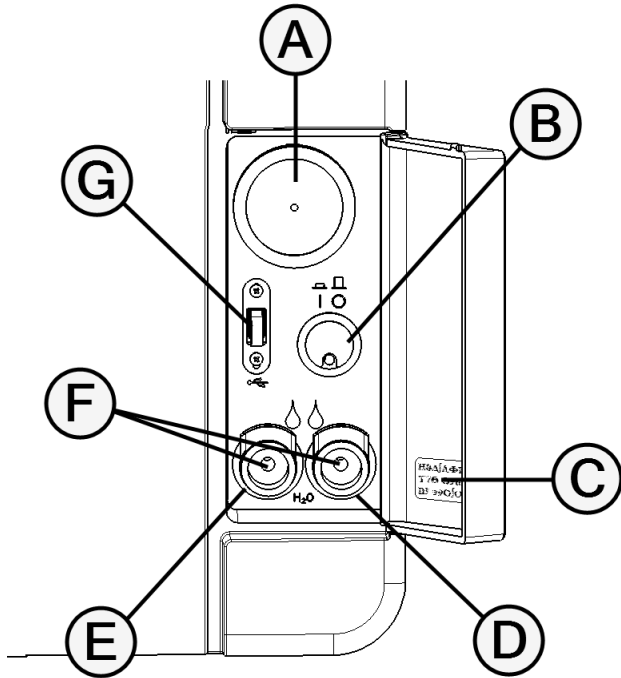

Part	Description
A	Bacteriological filter
B	Mains switch
C	Identification label
D	Used water drain port (grey)
E	Clean water drain port (blue)
F	Drain tube release button
G	USB port

## REAR VIEW

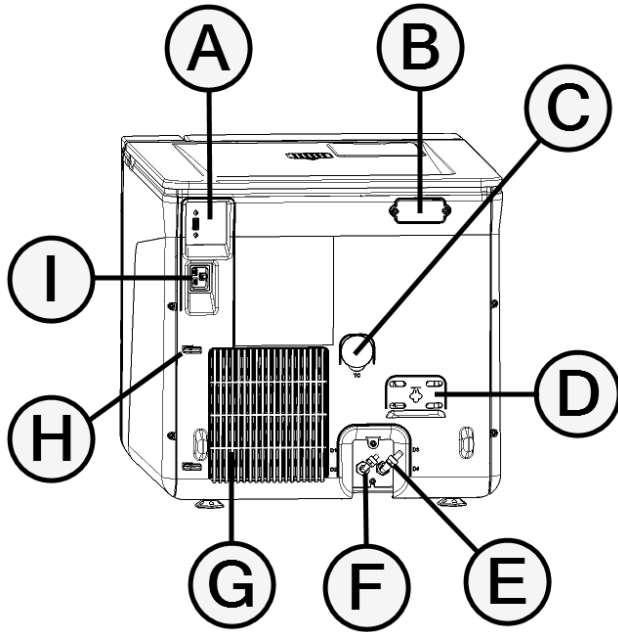

Part	Description
A	USB port (optional)
B	Air gap cover
C	Test connection
D	Pressure safety valve cover
E	Used water drain (optional)
F	Water supply inlet (optional)
G	Condenser grid
H	Mains cable guide
I	Mains cable plug socket



## CHAMBER ACCESSORIES

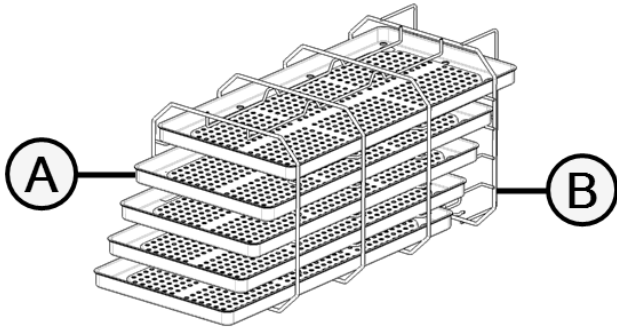

Part	Description
A	Tray
B	Chamber rack: <ul style="list-style-type: none"> <li>■ In the normal position, it can host 5 trays horizontally or 3 cassettes/containers vertically.</li> <li>■ In a 90° degrees rotated position, it can host 3 trays or 3 cassettes/containers horizontally.</li> </ul>

## Installing the sterilizer

### LOCATION REQUIREMENTS

#### Notice:

Do not place the sterilizer so that it is difficult to operate the controls behind the service door. Do not place the sterilizer so that it is difficult to disconnect the power supply plug.

Leave the condenser grid (rear side of the sterilizer) free from anything that might obstruct the air passage.

Surface materials should be water resistant. If sterilization cycles will be continuous, pay attention to the surrounding materials: steam can damage them.

The sterilizer must operate in absence of explosive atmospheres. The sterilizer must operate in a well ventilated room (indoor), far from sources of heat and from flammable materials.

Place the sterilizer on a flat and level surface.

Clearance requirements to ensure proper air circulation:

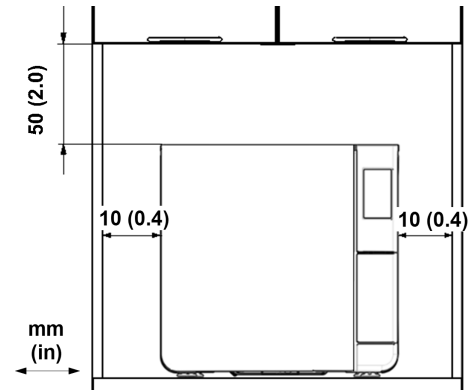

### ELECTRICAL CONNECTIONS

All the cables and tubes connected on the rear side of the sterilizer must be placed far from the condenser grid (e.g. using the available guides).

#### Notice:

Connect the sterilizer to a dedicated line. Do not use cable extensions nor multiple sockets/adapters.

Ensure that external and internal surfaces are free from moisture or condensation before connecting to power.

The installation of the sterilizer shall be performed by two authorized technicians using PPE (Personal Protective Equipment) according to applicable standards.

The electrical power supply of the sterilizer must fulfill all applicable standards in the country of use, and must comply with the data label on the back of the sterilizer.

## WATER CONNECTIONS

The sterilizer clean water tank can be filled manually by the user or automatically with a water supply system (optional). The water supply system must deliver demineralized or distilled water meeting the specifications listed in these instructions. Do not add any chemical/additive to the water.

The manufacturer's warranty is void if the sterilizer was used with water containing either chemical additives, or contaminant levels exceeding those listed in these instructions. See "Feed water specifications [EN 13060]" on page 102.

**Notice:** The maintenance of the external water filling system must be done in exact accordance with the Instructions for Use given with the relevant system.

## WI-FI CONNECTION (OPTIONAL)

For the Wi-Fi connection proceed as follows:

- 1** Insert the Wi-Fi key in the USB port.
- 2** Read the Instructions for Use provided with the Wi-Fi key.

**Note:** for details see also the "Wi-Fi key & APP - Quick start".

## INSTALLING THE STERILIZER



**WARNING!** In case of sterilizer malfunctions immediately unplug the sterilizer and call for service. Do not attempt to repair the sterilizer by yourself.

### Notice:

Please ensure that all installation requirements are met before plugging the sterilizer. See "Connection diagrams" on page 101. No other devices should be connected to the sterilizer power panel circuit.

- 1** Place the sterilizer on a sturdy, flat and level surface.
- 2** Open the chamber door, remove all items from the sterilizer chamber except the chamber rack. Remove all plastic covers from trays.
- 3** Connect the auto-fill and auto-drain tubes in the rear of the sterilizer (optional).
- 4** Connect the Ethernet cable or the Wi-Fi key in the rear of the sterilizer (optional).
- 5** Attach the power cord to the socket in the rear of the sterilizer and route the cord through the cable guides.
- 6** Connect the power cord to a wall outlet. For power supply requirements, see "Technical data" on page 98.
- 7** Ensure that the steam diffuser plate is correctly placed and engaged, as this is essential for the sterilization process.

# Operating the sterilizer

## POWER THE STERILIZER ON/OFF

- 1** Press the power switch behind the service door: once switched ON, the visual indicator on the power switch will turn green.
- 2** After a quick autotest the sterilizer automatically turns in standby mode. See "Standby mode" on page 29.
- 3** Tap **1**. The homepage appears with the enabled sterilization cycles.



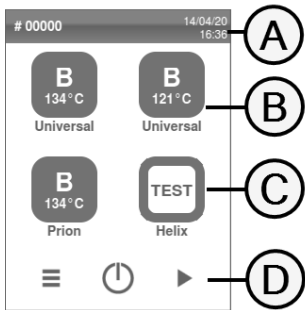



## HOMEPAGE DESCRIPTION











Part	Description
A	Title/purpose of the screen, or the cycle number and the current date and time
B	Available cycles <b>Note:</b> The S Naked 134 cycle is optional, activated with Fast Cycle activation code, see "S Naked 134 cycle activation" on page 48.
C	Available tests
D	Additional buttons used to navigate the menu.









## User interface menu





### MAIN MENU FUNCTIONS

Icon	Label	Function
	<b>Menu</b>	Opens the menu.
	<b>Settings</b>	Sets the device.
	<b>Traceability</b>	Opens the pages to monitor the performed cycle data and manage users and printing.
	<b>Accessories</b>	Opens the pages to select and calibrate the printers, format the USB pen drive and activate special functions.
	<b>Maintenance</b>	Carries out the maintenance procedure.
	<b>System Info</b>	<ul style="list-style-type: none"> <li>■ In general, shows the system information.</li> <li>■ During a cycle, shows the cycle parameters in real time.</li> </ul>





### SETTINGS MENU FUNCTIONS





Icon	Label	Function
	<b>Device</b>	Opens the pages to set the device.
	<b>Language</b>	Sets the language.
	<b>Date &amp; Time</b>	Sets time and date values and format.
	<b>Sterilizer Name</b>	Sets the sterilizer name.
	<b>Energy management</b>	Sets the standby mode.
	<b>Display</b>	Sets the display brightness.
	<b>Cycle</b>	Opens the pages to manage cycles.
	<b>Measurement Units</b>	Sets the unit of measure.

Icon	Label	Function
	<b>Connectivity</b>	Opens the pages to manage the network connection.
	<b>Ethernet</b>	Manages the Ethernet network.
	<b>Eliso Status</b>	Only if this service is supported in your Country, and if the sterilizer is connected to it. Shows the status of the connection with the W&H monitoring server.
	<b>Akidata status</b>	
	<b>IoDent</b>	
	<b>Wi-Fi</b>	Activates a communication protocol between the sterilizer and an external gateway to extend connectivity features.
	<b>Network Status</b>	Only with a network connection set. Provides information about the network status.
	<b>Remote data storage</b>	Only with a network connection set. Opens the page to manage the remote storage.
	<b>Settings</b>	Only with a network connection set. Sets the parameters of the network location.



Icon	Label	Function
	<b>Save all</b>	Only with a network connection set. Copies all the files in the specified location in the network.
	<b>Test</b>	Only with a network connection set. Checks if the files can be copied to the specified location.
	<b>USB options</b>	Enables/disables USB warning messages.
	<b>Traceability settings</b>	Chooses if the sterilizer is master or slave.







## TRACEABILITY MENU FUNCTIONS

Icon	Label	Function
	<b>Cycle History</b>	Shows all the sterilization cycles and tests and prints reports and labels.
	<b>Save</b>	Saves all the sterilization cycle reports in the USB pen drive.
	<b>User Management</b>	Optional, activated with an activation code. Permits manage the users.
	<b>Add User</b>	Administrator only. Adds a user.



Icon	Label	Function
	<b>Delete User</b>	Administrator only. Deletes a user.
	<b>Reset user PIN code</b>	Administrator only. Resets a user PIN code.
	<b>Change your PIN code</b>	Changes the PIN code.
	<b>Options</b>	Optional, activated with an activation code. Administrator only. Permits the following: <ul style="list-style-type: none"> <li>Identify and save the operator who starts the cycle and releases the load.</li> <li>Protect with a password the cycle start, the cycle stop and the load release.</li> </ul>
	<b>Label Printer</b>	Optional, activated with an activation code. <ul style="list-style-type: none"> <li>Sets the maximum storage time of the wrapped sterilized items.</li> <li>Sets the automatic or manual printing of the labels.</li> </ul>



## ACCESSORIES MENU FUNCTIONS

Icon	Label	Function
	<b>USB Pen Drive</b>	Opens the formatting page of the USB pen drive.
	<b>Format</b>	Formats the USB pen drive.

Icon	Label	Function
	<b>Label Printer</b>	Optional, activated with an activation code. Selects the label printer and sets the printout layout.
	<b>Local Printer</b>	Selects a printer connected to the sterilizer.
	<b>Calibration</b>	Adjusts the label printer to the edge of the label.
	<b>Test</b>	Prints a test label.
	<b>Printer</b>	Selects the printer model connected to the sterilizer.
	<b>Special Codes</b>	Saves the codes issued by the manufacturer to activate special functions. See "Activation codes" on page 109.

## MAINTENANCE MENU FUNCTIONS

Icon	Label	Function
	<b>Bact. Filter</b>	Shows the status of the bacteriological filter for replacement and resets its counter to zero.
	<b>Dust Filter</b>	Shows the status of the dust filter for replacement and resets its counter to zero.

Icon	Label	Function
	<b>Door Gasket</b>	Shows the status of the door gasket for replacement and resets its counter to zero.
	<b>4000 cycle service</b>	Shows the number of cycles performed and left before the necessary maintenance.
	<b>Software Update</b>	Updates the software.













## COMMON COMMANDS AND ICONS

Icon	Function
	Enters/exits the standby mode.
	Moves to the previous/next screen.
	Opens the homepage.
	Accesses to the sub-menus.
	Provides access to the setting screen of a specific area.
	Shows the list of all operating parameters of the sterilizer.
	Opens a screen with other settings/options.

Icon	Function
	Refreshes the page.
	Indicates the value that may be changed and appears by clicking on it.
	<ul style="list-style-type: none"> <li>Confirm the active option.</li> <li>Saves a setting or a parameter.</li> <li>Answers YES to a question.</li> </ul>
	<ul style="list-style-type: none"> <li>Aborts the action/function.</li> <li>Moves to the previous screen without confirming/making any changes nor saving any parameters.</li> <li>Answers NO to a question.</li> </ul>
	Indicates that the AUTO DRY mode is operating.
	Optional, activated with an activation code. Indicates that the ECO DRY plus mode is operating.
	Increases/decreases the value.





Icon	Function
	Indicates that an error occurs.
	Indicates that the option checked is working properly.
	<ul style="list-style-type: none"> <li>Plays a video.</li> <li>Starts a procedure.</li> </ul>
	Pauses a video.
	Indicates that the chamber door is locked.
	Indicates that the chamber door is locking/unlocking.
	Indicates that the chamber door is unlocked and can be open.
	Programs a succession of cycles for daily repetition.
	Indicates that the option is ON and allows to set it OFF by touching it.

Icon	Function
	Indicates that the option is OFF and allows to set it ON by touching it.
 	Indicates that the option is active/not active.
 	Indicates that the option is enabled/disabled.
	Indicates that the user is using the administrator credentials.
	Gives information about the function displayed.
	Confirms the active option and saves a setting or a parameter.
	Copy the system info to the USB pen drive.
	Shows an animation about the replacement procedure.

Icon	Function
	Shows a sterilization summary.







# Sterilizer setup

## SET THE LANGUAGE

- 1 On the homepage tap  >  >  > 
- 2 Tap the language you prefer.
- 3 Tap  to confirm: a confirmation message requiring the restarting of the sterilizer appears.
- 4 Turn the sterilizer OFF and then ON.







## SET THE DATE AND TIME

To change the current date and time:

- 1 On the homepage tap  >  >  > 
- 2 Tap the value you want to change (time, date, format): the highlighted value can be changed.
- 3 Tap  or  to change the value.
- 4 Tap  to confirm and go back to the previous page.







## SET THE STERILIZER NAME

To change the sterilizer name that appears in the cycle reports:

- 1 On the homepage tap  >  >  > 
- 2 Tap the text box: a keyboard appears.
- 3 Enter the new sterilizer name.
- 4 Tap  to confirm.
- 5 Tap  to go back to the previous page.











## SET THE DISPLAY BRIGHTNESS

To change the display brightness:

- 1 On the homepage tap  >  >  > 
- 2 Tap  or  to change the value.
- 3 Tap  to confirm and go back to the previous page.



## CONNECT TO A NETWORK

If you connect through an Ethernet cable, in most cases the sterilizer will connect to the network automatically. If it does not connect automatically, or if you are using a Wi-Fi dongle key, follow the following procedure under supervision of your IT manager / network administrator.

- 1 On the homepage tap  >  > .
- 2 If the connection is through the Ethernet cable, tap : the TCP/IP screen appears.
- 3 If the connection is through Wi-Fi key, tap : after a while, the sterilizer shows the available networks found. Choose the network, enter the credentials in the further screen, then tap  to confirm: the TCP/IP screen appears.  
  
**Note:** the  and  icons are disabled if the connectivity means (cable or Wi-Fi key) are not properly plugged.  
  
**Note:** in the TPC/IP screen, the  icon is visible only if you make any change. The Wi-Fi icon at the bottom will not be visible if you connect through Ethernet cable.
- 4 If your network supports dynamic IP addresses (ask your IT manager), enable the options **Dynamic** both in **IP Configuration** and in the **DNS Configuration** fields, then tap  to confirm: all entry fields are disabled.
- 5 If your network does not support dynamic IP addresses (ask your IT manager), enable the options **Static** both in **IP Configuration** and in the **DNS Configuration** fields. Tap on each entry field and enter the IP addresses (ask your IT manager for details). Then tap  to confirm.

## User authentication (optional)

### FUNCTION AVAILABILITY

To access the user management functions the **User Management** activation code must be entered. The activation code is required only at the first access to the **User Management**  or the **Options**  menus: after the code was entered, the function is enabled and there is no need to enter the code again.









To acquire the activation code please refer to the Activation code instructions.

### PIN MANAGEMENT

PIN "0000" is assigned as default to each new user. It has to be changed at the first login. When the PIN is reset the default value "0000" is reassigned.

### CHANGE YOUR PIN

Change your PIN the first time you use the sterilizer and if your PIN has been reset. This will prevent other users to use your account.

- 1 On the homepage tap  >  > .
- 2 Tap your user name.
- 3 Enter your current PIN and tap  to confirm.
- 4 Tap .
- 5 Enter your new PIN and tap  to confirm: a confirmation message with your new PIN appears.
- 6 Tap  and then  to go back to the previous page.

## WHAT TO DO IF YOU FORGET YOUR PIN

If...	Then...
you are a common user	contact the administrator
you are the administrator	contact your authorized service provider





## USB pen drive

### DESCRIPTION

A USB pen drive is available to be installed in order to automatically record all the sterilization cycle reports. The USB pen drive can be inserted equally into the front or rear port [optional].

**Notice:** Periodically remove the USB pen drive to save the cycle data on a computer or on another safe support.

### FORMAT THE USB PEN DRIVE

- 1 On the homepage tap  >  > .
- 2 Insert the USB pen drive in one of the two USB ports.
- 3 Tap .
- 4 Tap  to confirm: all data will be erased.

**Notice:** Formatting erases all data from the pen drive. Be sure you have already saved your data on a safe support before formatting.

## Standby mode

### DESCRIPTION

When in standby mode, the sterilizer display remains dark and the sterilizer chamber is not heated to save energy. If the sterilizer is not used for a certain period of time, it automatically switches to standby mode.







### ENTER THE STANDBY MODE MANUALLY

- 1 Homepage
- 2 Tap .

### EXIT THE STANDBY MODE

Tap  or open or close the chamber door.

## CHANGING STANDBY MODE DELAY TIME

- 1 On the homepage tap  >  >  > 
- 2 Tap  or  to change the delay.
- 3 Tap  to confirm and go back to the previous page.

# Administrator

## CONTENTS

This section deals with the following subjects:

User management (optional) .....	31
Traceability options (optional) .....	32

## User management (optional)

### FUNCTION AVAILABILITY

To access the user management functions the **User Management** activation code must be entered. The activation code is required only at the first access to the **User Management** (👤) or the **Options** (⚙️) menus: after the code was entered, the function is enabled and there is no need to enter the code again.

To acquire the activation code please refer to the Activation code instructions.





### WHO CAN MANAGE USERS AND RESET THEIR PIN

Only a user with administrator rights can create and delete users and reset the PIN code of a user to "0000".





## ADD A USER

- 1 On the homepage tap ☰ > 🏠 > 👤
- 2 Tap your user name.
- 3 Enter the PIN and tap ✓ to confirm.
- 4 Tap 👤+.
- 5 Tap the text box: a keyboard appears.
- 6 Enter the new user name and tap ✓ to confirm.
- 7 If desired, tap  to give the administrator authority to the new user.
- 8 Tap ✓ to confirm: the PIN of the new user is set to "0000" and a confirmation message appears.
- 9 Tap ✓ and then ◀ to go back to the previous page.
- 10 Tap 🏠 to return to the homepage.

## DELETE A USER

- 1 On the homepage tap  >  > 
- 2 Tap your user name.
- 3 Enter the PIN and tap  to confirm.
- 4 Tap .
- 5 Tap the user name you want to delete.
- 6 Tap  to confirm.



## RESET A USER PIN

- 1 On the homepage tap  >  > 
- 2 Tap your user name.
- 3 Enter the PIN and tap  to confirm.
- 4 Tap  and the user name for which you want to reset the PIN.
- 5 Tap  to confirm: the PIN is set to "0000" and a confirmation message appears.
- 6 Tap  to return to the homepage.

**Note:** Remember the user to change their PIN before reusing the sterilizer.

## Traceability options (optional)

### FUNCTION AVAILABILITY





To access the user management functions the **User Management** activation code must be entered. The activation code is required only at the first access to the **User Management**  or the **Options**  menus: after the code was entered, the function is enabled and there is no need to enter the code again.

To acquire the activation code please refer to the Activation code instructions.

### WHO CAN SET THE TRACEABILITY OPTIONS

Only a user with administrator rights can set the traceability options.

### SET THE TRACEABILITY OPTIONS

- 1 On the homepage tap  >  > 
- 2 Tap your user name.
- 3 Enter your PIN and tap  to confirm.
- 4 Tap the information to be requested to the users at the beginning and at the end of the cycle.
- 5 If you want the user to check the load and release it as valid at the end of the cycle, tap .
- 6 Tap  to confirm and go back to the previous page.



# Managing printers

## CONTENTS





This section deals with the following subjects:

Printer selection (optional) .....	33
Label printer selection (optional) .....	33
Label printer usage (optional) .....	34
Label content description .....	36

## Printer selection (optional)

### SELECT THE PRINTER

**Note:** The sterilizer only supports the specific printer models available through manufacturer/importer.

- 1 On the homepage tap  >  > 
- 2 Tap the model of the printer to use.
- 3 Tap  to confirm and go back to the previous page.

## Label printer selection (optional)











### FUNCTION AVAILABILITY

The first time you access the **Label Printer**  menu, you will be requested to enter an activation code. To require the activation code, please refer to the Activation code instructions provided with the label printer.

### LABEL PRINTER SETUP

Labels can be printed by a local label printer or a shared label printer. The local label printer is connected to the sterilizer, while the shared label printer is connected to another sterilizer in the network.

## SELECT AND CALIBRATE A LOCAL LABEL PRINTER

- 1 On the homepage tap  >  > 
- 2 Tap : the local printer is located automatically.
- 3 Tap  to center the printout properly in the label area.
- 4 Tap  to print a test label.
- 5 If the printout is not duly centered, tap  or  to center it horizontally (x) and vertically (y).
- 6 If necessary, tap  to print another test label and repeat step 4.
- 7 Tap  to confirm the settings and go back to the previous page.

## Label printer usage (optional)



**CAUTION!** For your safety and the safety of your patients use a storage time compliant with the recommendations of the manufacturers of the containers/packaging used, and with applicable norms and rules.

## FUNCTION AVAILABILITY







The first time you access the **Label Printer**  menu, you will be requested to enter an activation code. To require the activation code, please refer to the Activation code instructions provided with the label printer.

## AUTOMATIC PRINTING OPTION

The automatic printing option permits to automatically print a preset number of labels after a successful sterilization cycle. The labels are printed only after the user has identified him/herself (with password if required) and the load has been checked and released, if these options have been enabled by the administrator.



For the automatic label printing, a maximum storage time in weeks can be set. This value is used to calculate the expiry date to be printed on the labels (see "Label content description" on page 36).

## SET THE AUTOMATIC LABEL PRINTING

- 1 On the homepage tap  >  > 
- 2 Activate **Automatic printing**.
- 3 Tap  or  to set the maximum storage time and the number of labels to be printed automatically.
- 4 Tap  to confirm and go back to the previous page.





## SET THE MANUAL LABEL PRINTING

The manual printing option permits the user at the beginning of a sterilization cycle to set manually the number of labels to print.

- 1 On the homepage tap  >  > 
- 2 Activate **Manual printing**.
- 3 Tap  to confirm and go back to the previous page.

## DISABLE THE LABEL PRINTING

If the label printing is disabled, no label can be printed at the end of a sterilization cycle.

- 1 On the homepage tap  >  > 
- 2 Activate **Disabled**.
- 3 Tap  to confirm and go back to the previous page.

# Label content description

## STRUCTURE

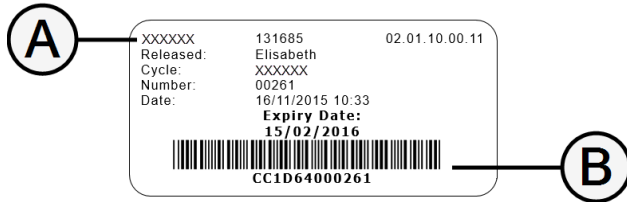

Part	Description
<b>A</b>	<ul style="list-style-type: none"> <li>■ Sterilizer model</li> <li>■ Serial number</li> <li>■ Software release</li> </ul>
<b>B</b>	Traceability code [alphanumerical and bar code]
<b>Released</b>	Depending on the traceability settings, this field may contain one of the following elements: <ul style="list-style-type: none"> <li>■ the user who released the cycle</li> <li>■ the user who started the cycle</li> <li>■ the sterilizer ID</li> </ul>
<b>Cycle</b>	Cycle name
<b>Number</b>	Cycle number
<b>Date</b>	Date and time of cycle start
<b>Expiry date</b>	<ul style="list-style-type: none"> <li>■ Expiry date of the bag/package.</li> <li>■ The cycle outcome if a storage time is not set.</li> </ul>

# Sterilizer tests

## CONTENTS

This section deals with the following subjects:

Sterilizer performance tests .....	37
Bowie and Dick test .....	37
Helix test .....	40
Vacuum test .....	42

## Sterilizer performance tests

### TESTS THAT CAN BE PERFORMED ON THE STERILIZER

Test	Purpose	Reference
Bowie and Dick test	Validate the sterilizer performance for textile load sterilization.	See "Bowie and Dick test" below.
Helix test	Validate the sterilizer performance for hollow items.	See "Helix test" on page 40.
Vacuum test	Validate the sterilizer performance in terms of: <ul style="list-style-type: none"><li>■ efficiency of the vacuum pump</li><li>■ tightness of the pneumatic circuit</li></ul>	See "Vacuum test" on page 42.

## Bowie and Dick test



**CAUTION!** Follow local/national guidelines on the frequency of testing.



## PURPOSE OF THE TEST

The test is used to validate the sterilizer performance for textile load sterilization.

## DESCRIPTION

It consists of several sheets of paper wrapped in a small packet with a chemical heat-sensitive indicator sheet in the middle. The colour assumed by this indicator sheet at the end of the sterilization cycle gives the result of the test.

## CARRY OUT THE TEST (IN ACCORDANCE WITH EN13060)

- 1 Empty the sterilizer chamber to ensure no load is present. Remove all trays from the sterilization chamber, except the lowest one.
- 2 Place the Bowie and Dick test pack in the center of a tray in the lowest rack position and close the chamber door.
- 3 On the homepage tap **Helix-B&D test**.
- 4 To set the duration of the Plateau/Sterilization phase and other settings, tap .
- 5 Tap  and enter your credentials if required: the chamber door locks.
- 6 Wait until the end of the test and tap **OPEN**: the chamber door unlocks.
- 7 Enter your credentials if required.
- 8 Open the chamber door, extract the tray using the tray holder and take the test pack. The test pack can be wet outside.



**CAUTION!** Risk of burns. The test pack is very hot at the end of the cycle. Wear appropriate PPE (e.g. gloves).

- 9 Remove the indicator sheet from the center of the test pack and check the change in colour. See "Interpret the test result" on the next page

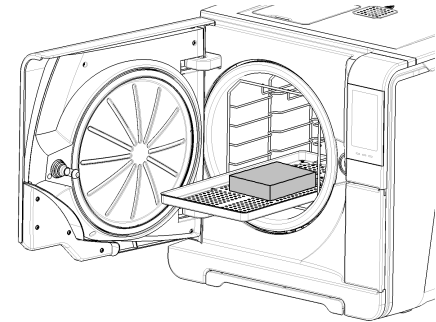

## INTERPRET THE TEST RESULT

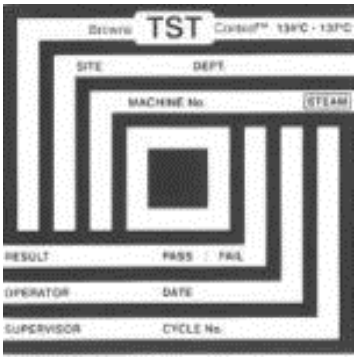
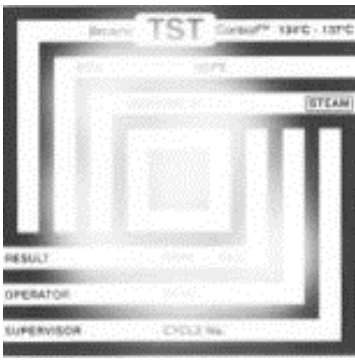
Indicator	What happened	Test passed	What to do next
 <p>The image shows a TST indicator strip with a uniform black color. The strip contains the following text: 'Biorad TST Control 138°C - 137°C', 'SITE DEPT.', 'MACHINE No. (STEAM)', 'RESULT PASS FAIL', 'OPERATOR DATE', and 'SUPERVISOR CYCLE No.'.</p>	<p>The entire surface of the indicator sheet has changed colour.</p>	<p>Yes</p>	<p>-</p>
 <p>The image shows a TST indicator strip with a white center and black outer edges. The strip contains the following text: 'Biorad TST Control 138°C - 137°C', 'SITE DEPT.', 'MACHINE No. (STEAM)', 'RESULT PASS FAIL', 'OPERATOR DATE', and 'SUPERVISOR CYCLE No.'.</p>	<p>Certain areas of the indicator sheet have not changed colour since there was an air pocket during the cycle due to sterilizer malfunction.</p>	<p>No</p>	<p>Repeat the test. If it fails repeatedly, call technical service.</p>

## Helix test



**CAUTION!** Follow local/national guidelines on the frequency of testing.

### PURPOSE OF THE TEST

The test is used to validate the sterilizer performance for hollow items.

### DESCRIPTION



It consists of a 1.5 m long tube open on one side and closed with a capsule containing a chemical indicator strip on the other side. The colour assumed by this indicator strip at the end of the sterilization cycle gives the result of the test.

### CARRY OUT THE TEST (IN ACCORDANCE WITH EN13060)

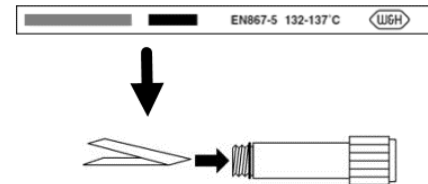
- 1** Empty the sterilizer chamber to ensure no load is present. Remove all trays from the sterilization chamber, except the lowest one.
- 2** Unscrew the tube capsule and place inside it an indicator strip according to the instructions of the test manufacturer.
- 3** Screw the capsule.





- 4 Place the tube with the capsule in the center of a tray in the lowest rack position and close the chamber door.
- 5 On the homepage tap **Helix-B&D test**.
- 6 To set the duration of the Plateau/Sterilization phase and other settings, tap .
- 7 Tap  and enter your credentials if required: the chamber door locks.
- 8 Wait until the end of the test and tap **OPEN**: the chamber door unlocks.
- 9 Enter your credentials if required.
- 10 Open the chamber door, extract the tray using the tray holder and take the tube.





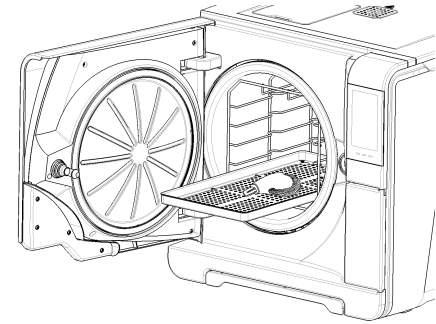

**CAUTION!** Risk of burns. The test pack is very hot at the end of the cycle. Wear appropriate PPE (e.g. gloves).

- 11 Unscrew the tube capsule and remove the indicator strip.
- 12 Check the change in colour. See "Interpret the test result" below

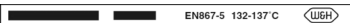

## INTERPRET THE TEST RESULT

Indicator	What happened	Test passed	What to do next
 EN867-5 132-137 °C 	The indicator strip has turned dark. The air was completely removed from the capsule.	Yes	-
 EN867-5 132-137 °C 	Part of the chemical indicator strip has not turned dark. The air removal from the capsule was not complete.	No	Repeat the test. If it fails repeatedly, call technical service.

## WHAT TO DO NEXT

Compile the Helix test documentation form to trace the effectiveness of the sterilization cycle during the whole lifespan of your sterilizer. See "Helix test documentation form" on page 112.

## Vacuum test



**CAUTION!** Follow local/national guidelines on the frequency of testing.

**Notice:** If a drainage period of the S Naked 134 cycle is still operating, wait the drainage to be finished and the sterilizer to be both cold and dry. Otherwise, a false negative outcome could occur.

## PURPOSE OF THE TEST

The test is used to validate the sterilizer performance in terms of:

- efficiency of the vacuum pump
- tightness of the pneumatic circuit

## DESCRIPTION

It consists of a vacuum phase, followed by a stabilization period of 5 minutes and a testing period of 10 minutes. The internal pressure is monitored during the testing period. The pressure rise must be less than 0.013 bar (0.19 psi).

## CARRY OUT THE TEST

- 1 Empty the sterilizer chamber to ensure no load is present.
- 2 Close the chamber door and ensure the sterilizer chamber is completely dry and cold to avoid any false negative outcome.
- 3 On the homepage tap **Vacuum test**.
- 4 Tap  and enter your credentials if required: the chamber door locks.
- 5 Wait until the end of the test and tap **OPEN**: the chamber door unlocks.
- 6 Enter your credentials if required: a message informs if the test passed or failed. If the test failed, see "What to do when the test failed" below

## WHAT TO DO WHEN THE TEST FAILED

- 1 Check, clean or replace the door gasket.
- 2 Clean the chamber face side and the chamber filter.
- 3 Repeat the Vacuum test. See "Carry out the test" above.
- 4 If the test fails repeatedly, call technical service.

# Sterilization cycles

## CONTENTS

This section deals with the following subjects:

Load maintenance and preparation .....	44
Prepare the sterilizer .....	46
Sterilization cycle description .....	47
Sterilization cycle management .....	48
Unloading .....	52
Sterilization cycle report .....	52

## Load maintenance and preparation

### WARNINGS



**WARNING!** Any residual of chemicals (like cleaning and disinfection products), could affect the purity of the steam and consequently the whole sterilization process. If necessary, the load shall be cleaned and lubricated in accordance with the instrument manufacturer's instructions.

**Notice:** Any residual of chemicals could seriously damage the sterilizer. The manufacturer's warranty is void in case of damage caused by chemicals.

## DENTAL HANDPIECES EXTERNAL DISINFECTION

This procedure reduces the risk of infection during cleaning and maintenance of the dental handpieces.

- Wear protective gloves during disinfection.
- Avoid using abrasive disinfectants (pH-value 2.5 – 9; no chlorine based disinfectants).
- Use disinfectant wipes rather than spray disinfection.
- Do not immerse handpieces in disinfectants.
- Residual disinfectants on handpieces can cause extensive damage to your instrumentation during sterilization (oxidation, alteration of technical characteristics of seals, rubbers, fiber optics, etc.)

## DENTAL HANDPIECES EXTERNAL CLEANING

This procedure involves the removal of residues (blood, dentine, etc.) that adhere to critical areas such as spray outlets, light ports, knurling etc.

- Wear protective gloves during cleaning.
- Refer to the instructions of the instrument manufacturer.
- Use a soft, damp brush and take care not to scratch the surface of the light ports.

## DENTAL HANDPIECES LUBRICATION

Once the dental handpieces has been disinfected, cleaned and dried (free from residues), it must be lubricated prior to sterilization. Follow manufacturer's instructions for proper lubrication.

## PACKAGING

In order to preserve sterility, rotating instruments should be wrapped/bagged prior to sterilization. Follow the manufacturer's packing instructions when using sterilization packaging.

## CLEANING THE INSTRUMENTS

Clean all instruments thoroughly prior to sterilization. If possible, clean instruments immediately after use; always follow the instrument manufacturer's instructions. Remove all traces of disinfectants and detergents. Rinse and dry carefully all instruments.

The instruments and tubes must be carefully rinsed and dried prior to sterilization.

## CORRECT LOAD PLACEMENT



**WARNING!** Do not overload trays and the chamber. Adhere to the maximum load weight limits (see "Sterilization cycles" on page 91).

**Never place the load or the trays directly into the chamber without the chamber rack as this could affect the steam and temperature distribution. The load must always be supported by the chamber rack. Risk of burns. Before touching, ensure the sterilization chamber is cold.**



*Wrap items with porous wrapping materials to facilitate steam penetration and drying (e.g. sterilization bags for autoclaves). Always use the chamber rack to allow adequate steam circulation.*

Follow these requirements:

Load type	Placement
Hinged instruments (e.g., forceps, extraction pliers, etc.)	In open position
Tubes	Place tubes on a tray allowing the ends to remain open. Do not bend tubes.
Cassettes	Cassettes can be placed vertically or horizontally into the chamber rack (vertical placement enhances drying). When placing cassettes horizontally, slide them into the rack position without putting them on trays (if size allows) to enhance drying. When sterilizing double-decker cassettes, place them in the lowest rack position as there is more space height-wise.

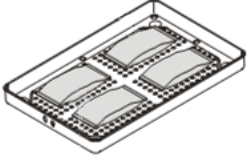
Load type	Placement
Pouched items	On trays allowing adequate space in-between bags. Ensure that packs do not touch the walls of the chamber. Place sterilization pouched items with the paper side facing up. 
Empty containers or non-perforated trays	Upside down to prevent accumulation of water
Items made from different materials (stainless steel, carbon steel, aluminum, etc.)	On separate trays or wrapped/pouched
Instruments manufactured from carbon steel	Place paper among them and the trays to avoid rusty spots

## PARTIAL LOAD

If the chamber is just partially loaded, place the load in such a way that the space in-between the trays is maximized. Spread items evenly on multiple trays. Below is a example with three trays.

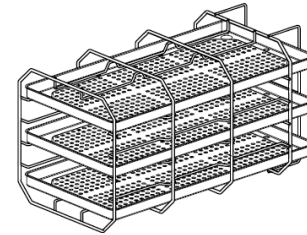

## Prepare the sterilizer

### WARNINGS

**Notice:** Use only distilled or demineralized water (see "Feed water specifications (EN 13060)" on page 102 for technical requirements). Do not add any chemical / additive to the water.

## HOOKING AND REMOVING THE STEAM DIFFUSER PLATE



**WARNING!** Ensure that the steam diffuser plate is firmly hooked in its position before starting a sterilization cycle. An improper positioning of the steam diffuser plate could result in bad steam quality and could impair the sterilization process, with risk of non sterile load and cross infection.

**Sterility at the end of the cycle is not guaranteed if the steam diffuser plate was not correctly placed.**

To hook the steam diffuser plate, slide it into the chamber until it gets engaged into the end hooks.

To remove the steam diffuser plate, press it in the center of the end edge (1) and slide it outwards (2).



## FILLING THE CLEAN WATER TANK

- 1** Switch the sterilizer ON and remove the tank filling cover-cap.
- 2** Fill the clean water tank with distilled or demineralized water until the sterilizer makes a sound. See "Technical data" on page 98 for the tank volume.
- 3** Reposition the tank filling cover-cap.

## INSERTING THE CHAMBER RACK INTO THE STERILIZER



**CAUTION!** Risk of burns. Before touching the chamber rack or contents, ensure the sterilization chamber is not hot.

- 1** Open the chamber door and align the chamber rack at the center/bottom of the chamber.
- 2** Push the chamber rack gently into position until it clicks into place.
- 3** Insert cassettes horizontally or vertically, or insert trays. See "Load maintenance and preparation" on page 44 for load requirements and "Chamber accessories" on page 17.
- 4** Close the door.
- 5** Turn the sterilizer switch ON: after the initialization the homepage appears.

## GENERAL RECOMMENDATIONS

Follow these recommendations to obtain the most from the drying:

- Ensure the paper side of the sterilization bags faces up, and that the space in-between bags is enough.
- To enjoy the full benefit of short cycle times when only one tray is used, always place the load on the upper tray of the chamber rack and remove all other trays from the chamber.

## Sterilization cycle description

### AVAILABLE STERILIZATION CYCLES

See "Sterilization cycles" on page 91 for the full list of key program features, including sterilization time, temperature and recommended load type.

## ECO-B MODE

ECO-B is a cycle option designed to reduce the cycle duration and the overall energy consumption, providing a fast type B cycle for a limited load weight (0.5 kg of wrapped instruments only!).

The ECO-B option is available for the B Universal 134 and B Extended 134 cycles only.



**WARNING! For your safety and the safety of your patients never exceed the maximum load weight limits as this could impair the sterilization process.**





## Sterilization cycle management

### S NAKED 134 CYCLE ACTIVATION

**Note:** If you have entered the All in One activation code in **Special Codes** menu, the function is already available.

To activate the S Naked 134 cycle is required the S Naked activation code. To require the activation code please refer to the Activation code instructions.

To activate the cycle proceed as follows:



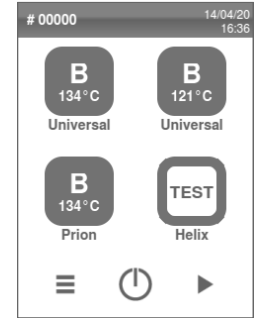

- 1 On the homepage tap  >  > .
- 2 Enter the activation code issued by the manufacturer and tap  to confirm: on the homepage the S Naked 134 cycle appears.

## RUN A STERILIZATION CYCLE IMMEDIATELY

- 1 On the homepage tap the desired cycle.
- 2 Check the cycle requirements and load the sterilizer.
- 3 If the door gasket is new, hold the door gently closed until the beginning of the cycle.









- 4 Select the ECO mode based on the weight of the load to be sterilized.
- 5 Tap  and enter your credentials if required: the door locks. If you have not set a different start time, the sterilization starts immediately.
- 6 Wait the end of the sterilization. Tap  to view the cycle parameters in real time. See "View the cycle parameters" on the next page.
- 7 The sterilization is completed. Tap  to view the cycle summary or tap  to view the cycle information. See "View the cycle parameters" on the next page.
- 8 Tap **OPEN**: the door unlocks.
- 9 If required, enter your credentials and confirm the release of the load if needed.





## SET THE STERILIZATION CYCLE START

You may schedule the start of the sterilization cycles at a certain date and time (e.g., if you want to load the sterilizer in the evening and run standard sterilization cycle early the next morning before office hours). You can set the cycle start date and time and enable or disable it for each cycle.

- 1 On the homepage tap the cycle.
- 2 To change the start time, tap **Start cycle at**.
- 3 Tap the time or the date: a settings page opens.
- 4 Tap the number you want to change and tap  or  to increase it or decrease it.
- 5 Tap  to confirm and go back to the previous page.
- 6 Tap  to lock the door and start the countdown for the current cycle.  
**Note:** You can decide to start the cycle immediately or stop the countdown at any time.



## SET THE DRYING TIME

The drying time of the AUTO DRY and ECO DRY plus modes is automatically adjusted to the total amount of load and cannot be modified (see "Sterilization cycle description" on page 47). To set a new drying time for the program, you should disabled the AUTO DRY and ECO DRY plus modes first.

- 1 On the homepage tap the cycle and .
- 2 Tap the time: a settings page opens.
- 3 Tap  or  to increase the minutes or decrease them.  
**Note:** for the minimum value of the drying time for each cycle see "Sterilization cycles" on page 91.
- 4 Tap  to confirm and go back to the previous page. If **Remember next time** is selected, this becomes the new fixed value.

## VIEW THE CYCLE PARAMETERS



You can check the real time cycle parameters or the cycle parameters at the end of the cycle. Following is an example:

- 1 While the sterilization cycle is running or when cycle ends tap  : the cycle information page opens.
- 2 Tap  or  to scroll the pages.

## STERILIZATION CYCLE PAGE

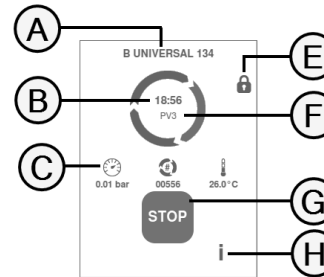

Following are the information displayed while a cycle is running:



Part	Description
A	Sterilization cycle name
B	Countdown clock (time until the cycle completion)
C	 : chamber pressure  : cycle counter  : chamber temperature
D	Date and time and door securely locked symbol
E	Current cycle phase
F	Stop button
G	Button to open the cycle information page

## END OF A STERILIZATION CYCLE

When a cycle is successfully finished, the "Cycle completed" message appears on the screen. To end the cycle:

- 1 Tap  to view the cycle summary or tap  to view the cycle parameters. See "View the cycle parameters" on the previous page.
- 2 Tap **OPEN** to open the door: the door unlocks and the home page appears.

**Note:** if an error message appears see "Troubleshooting" on page 82



**CAUTION!** Hot surfaces. Burnings. Do not touch the chamber, the internal side of the door and the internal fittings. Use the tray holder or cassette holder or gloves for high temperatures or adequate protection to remove the load!

- 3 Open the chamber door.
- 4 Remove the load and stock it.



## STOP A STERILIZATION CYCLE



**WARNING!** You can stop the cycle at any time. Instruments must not be considered sterile if this occurs before the DRY phase.

A cycle can be manually aborted at any time. To stop a cycle:

- 1 Tap **STOP**: a confirmation request appears.

- 2 Tap  to abort the stop command. The cycle continues programmed.
- 3 Tap  to abort the cycle: the sterilizer starts a reset phase.

**Notice:** Do not switch off the sterilizer during the reset phase: it takes some time to reset the system and reach safe conditions in the sterilizer chamber.

- 4 Check the message. See "Messages of a stopped sterilization cycle" on the next page.
- 5 Tap  to view the cycle parameters. See "View the cycle parameters" on the previous page.
- 6 Open the chamber door.
- 7 Reprocess the load if necessary.



**CAUTION!** Hot steam. Wait the steam to dissipate before opening the door.

**Note:** Water could be present in the chamber when opening the door. To prevent spilling place a towel below the chamber door.

## MESSAGES OF A STOPPED STERILIZATION CYCLE

Following are the messages:

- Load not sterile: Do not use items on patients!
- Drying interrupted: The load might be wet. Wet items are for immediate use only!

## Unloading

### WARNINGS



**CAUTION!** Risk of burns. Before touching, ensure the sterilization chamber is cold. Always use the tray holder.

## Sterilization cycle report

### WHERE CYCLE DATA ARE STORED

The sterilizer stores in memory the summarized reports of the last 400 cycles and the analytical reports of the last 100 cycles. All reports can also be saved on the USB pen drive.

### STORED REPORT FORMAT

The summarized reports are stored in HTML format and the analytical reports in SCL format. All parameters are recorded every second.

## WHAT HAPPENS WITH UNSAVED CYCLES

If for any reason (e.g. USB memory full, USB pen drive disconnected, etc.) some cycles cannot be saved, no alert is shown. If still stored in memory, the unsaved cycles will be copied in a working USB pen drive connected to the sterilizer as soon as a new cycle starts.

## VIEW CYCLE HISTORY

To view the sterilization cycle history:







- 1 On the homepage tap > : all the sterilization cycles are listed with number, date, time and sterilization program. The sterilization cycle interrupted because of a cycle error or problem appears in red.
- 2 Scroll the list and tap the desired sterilization cycle: the report opens.

## PRINT OR SAVE A CYCLE REPORT ON THE USB PEN DRIVE

- 1 On the homepage tap > >
- 2 Scroll the list and tap the desired sterilization cycle: the report opens.
- 3 Tap .
- 4 Tap to print the report, or tap to save the report on the USB pen drive.





## PRINT LABELS FOR A SPECIFIC CYCLE

**Note:** Function available only with the Label printer activation code.

- 1 On the homepage tap  >  > 
- 2 Scroll the list and tap the desired sterilization cycle: the report opens.
- 3 Tap .
- 4 Tap  to print traceability labels for the selected cycle.
- 5 Tap  or  to increase or decrease the number of label to be printed.
- 6 Tap  to save the set number for the next time.
- 7 Tap  to print the labels required.

## SAVE ALL THE CYCLE REPORTS ON THE USB PEN DRIVE

The number of reports that can be saved on the USB pen drive depends upon the USB capacity. To save all the cycle reports:

- 1 On the homepage tap  >  > 
- 2 Tap  : after the confirmation all sterilization cycle reports are stored in the USB.





## SET THE REMOTE FOLDER FOR SAVING THE REPORTS (OPTIONAL)

### Function availability

The first time you access the **Remote data storage**  menu, you will be requested to enter an activation code. To require the activation code, please refer to the Activation code instructions.







## Procedure

To activate the remote storage and set the necessary parameters do the following:

- 1 On the homepage tap  >  >  > 
- 2 Tap  to enable the remote data storage: the first four fields in the page and the check box turn dark grey.
- 3 In **Path** enter the name of the shared folder followed by the sub-folder name, if any, where to save reports. Do not enter the full path.  
**Note:** The folder name must include letters and numbers only. Do not use other characters like space-bar, slash, accent, etc.
- 4 Enter the host name or the IP address: if the data are complete, the fields highlight.
- 5 Not mandatory. Enter the domain name.
- 6 Tap  to require the authentication credentials to access the remote storage folder and enter the user name and password.
- 7 Tap  to save.
- 8 Tap  to go back to the previous page.
- 9 To check if the parameters entered are valid, see "Test the data storage [optional]" below.

## TEST THE DATA STORAGE (OPTIONAL)





**Note:** The test function is available only if the remote data storage is enabled. See "Set the remote folder for saving the reports [optional]" on the previous page.

- 1 On the homepage tap  >  > 
- 2 Tap : a sequence of tests is automatically performed.
- 3 In case a test fails, check the relevant settings and tap  to repeat the test sequence, if the error persists call your IT manager.
- 4 Tap  to go back to the previous page.

## SAVE ALL THE CYCLE REPORTS IN A REMOTE FOLDER (OPTIONAL)

**Note:** The save all function is available only if the remote data storage is enabled. See "Set the remote folder for saving the reports [optional]" on the previous page.

Only the last 400 cycles in HTML and 100 cycles in SCL in the sterilizer memory can be saved in the remote folder.

- 1 On the homepage tap  >  >  > 
- 2 Tap  to start the remote saving.

## CYCLE REPORT STRUCTURE

Following the structure of a cycle report:

A

XXXX		SN:000056			
Software Rev.:	004.000.P13				
Sterilizer ID:	XXXX				
Cycle:	XXXX				
Number:	00059				
Sterilizat. temp.:	134.0 °C				
Sterilizat. time:	03:30				
Date:	12/12/2017 12:09:26				
<b>Phase</b>	<b>Time</b>	<b>Partial</b>	<b>T °C</b>	<b>P bar</b>	
START	00:00	00:00	25.7	0.01	
PV1	00:02	00:02	25.7	0.01	
PP1	00:04	00:02	25.7	0.01	
PV2	00:06	00:02	25.7	0.01	
PP2	00:08	00:02	25.7	0.01	
PV3	00:10	00:02	25.7	0.01	
PP3	00:12	00:02	25.7	0.01	
PPH	00:14	00:02	25.7	0.01	
PRS	00:14	00:00	25.7	0.01	
	MIN	00:00	0.0	----	
	MAX	00:00	0.0	----	
	MIN	00:00	----	-1.01	
	MAX	00:00	----	-1.01	
PRE	00:16	00:02	25.7	0.01	
DVS	00:16	00:00	25.7	0.01	
	D01	00:00	25.7	0.01	
	D02	00:00	25.7	0.01	
	D03	00:00	25.7	0.01	
	D04	00:02	25.7	0.01	
DRY	00:18	00:02	25.7	0.01	
LEV	00:20	00:02	25.7	0.01	
END	00:20	00:00	25.7	0.01	
Cycle time:	00:20				
Date:	12/12/2017 12:09:46				
	cycle completed				
Trk.	CC0003800059				

Data	Description
A	Sterilizer model
SN	Sterilizer serial number
Software rev.	Software revision number
Sterilizer Name	Surgery – practice – doctor name
Cycle	Name of the executed cycle
Number	Cycle counter
Sterilizat. temp.	Programmed sterilization temperature
Sterilizat. time	Programmed Plateau/Sterilization
Date (above)	Cycle start date and time
START	Cycle start
PV1, PP1, PV2, PP2, PV3, PP3	Pressure and vacuum pulses
PPH	Phase of pressure rise to sterilization conditions
PRS	Plateau/Sterilization phase start <ul style="list-style-type: none"> <li>■ MIN, MAX temperature</li> <li>■ MIN, MAX pressure</li> </ul>
PRE	Plateau/Sterilization phase end
DVS	Drying phase start
DRY	Drying phase end
LEV	Pressure leveling phase
END	Cycle end conditions

<b>Data</b>	<b>Description</b>
<b>Cycle time</b>	Cycle time
<b>Date (below)</b>	Cycle end date and time
<b>"Cycle completed"</b>	Cycle outcome
<b>Trk.</b>	Tracking code for traceability management



# Maintenance

## CONTENTS

This section deals with the following subjects:

Warnings for maintenance operations .....	57
Ordinary maintenance .....	57
Monthly or 50-cycle maintenance .....	59
400-cycle maintenance .....	64
800-cycle or biannual maintenance .....	66
800-cycle maintenance .....	72
4000 cycle or five-year maintenance .....	74
Extraordinary maintenance .....	75
Disposal .....	76

## Warnings for maintenance operations

### WARNINGS



**WARNING!** Turn the sterilizer OFF and remove the power cord before beginning any maintenance. Follow all health, safety, cross-infection and cross-contamination protocols. Maintenance operation shall be done at illumination level of 215 lx ( $\pm 15$  lx) to 1500 lx ( $\pm 15$  lx). Before making any operation, ward off unauthorized personnel from the working area.



**CAUTION!** Before accessing the chamber and the connected parts, be sure that the sterilizer is cold.

**Notice:** Follow the instructions in this chapter when carrying out any maintenance on the sterilizer.

## Ordinary maintenance

### MAINTENANCE BY THE USER

Frequency <sup>1</sup>	Cycles <sup>1</sup>	Operation
Monthly	50	Cleaning the door gasket and the chamber face side. See "Cleaning the door gasket and the chamber face side" on page 59 Clean the chamber, steam diffuser plate, trays and the rack. See "Cleaning the chamber and the chamber accessories" on page 60 Cleaning the chamber filter. See "Cleaning the chamber filter" on page 61 Cleaning the external surfaces of the sterilizer. See "Cleaning the external surfaces of the sterilizer" on page 63
6 month	800	Clean both water tanks. See "800-cycle or biannual maintenance" on page 66.

Frequency <sup>1</sup>	Cycles <sup>1</sup>	Operation
Yearly <sup>2</sup>	400 <sup>2</sup>	Replace the bacteriological filter. See "400-cycle maintenance" on page 64. Replace the dust filter. See "400-cycle maintenance" on page 64
Yearly <sup>2</sup>	800 <sup>2</sup>	Replace the door gasket. See "800-cycle maintenance" on page 72.
5 years	4000	General check and service. See "4000 cycle or five-year maintenance" on page 74.

**Note 1:** Whichever occurs first.

**Note 2:** Even if the maximum cycle number is not reached, it is recommended to replace the consumable parts every year, or if they appear worn or damaged, or if the filters are clogged or discolored.

## EXPIRED MAINTENANCE

The sterilizer monitors the wear of consumables by counting the number of cycles executed since the last replacement.



When the number of cycles is close to the maximum, a pre-alert about the concerned consumable is displayed. Please check that you have the requested spare part available, buy one if not. When the maximum number of cycles has been met, a message to replace the consumable will be displayed.

If you can not replace the consumable immediately, the sterilizer will operate anyway but the message will appear again some cycles later.

When you have replaced the consumable tap  to confirm: the executed cycle counter is reset.

## REPLACE THE CONSUMABLE BEFORE THE MAINTENANCE DUE DATE

If you replace the consumables before the request of replacement appears, you should manually reset the counters through the following procedure.

- 1 On the homepage tap  > 
- 2 Select the consumable you want to replace: a message appears showing the current worked hours of the part.
- 3 When you have replaced the consumable tap  to confirm: the executed cycle counter is reset.

## Monthly or 50-cycle maintenance

### CLEANING THE DOOR GASKET AND THE CHAMBER FACE SIDE

Proceed as follows:

- 1 Clean the seal seat and the chamber face side with a damp, lint-free cloth moistened with clean water.

**Notice:**

Do not use abrasive products, cutting tools or sharp objects.

If you use a detergent solution, be careful not to get in contact with the plastic body of the front cover.

- 2 Rinse with clean water.

**Note:** when the seal is new it might be necessary to hold the door gently closed at the sterilization start.

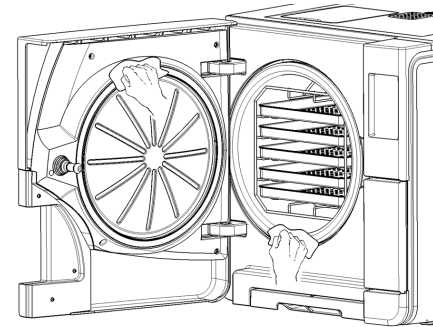

## CLEANING THE CHAMBER AND THE CHAMBER ACCESSORIES

Proceed as follows:

- 1** Remove the trays, the chamber rack and the steam diffuser plate.
- 2** Clean the chamber with a damp sponge and a mild detergent solution paying attention not to bend or damage the temperature probe inside the sterilizer chamber.
- 3** Rinse with water.
- 4** Clean the trays, the chamber rack and the steam diffuser plate with a damp sponge and a mild detergent solution.
- 5** Rinse with water.
- 6** Reposition all pieces of the chamber accessories properly.



**WARNING! Ensure that the steam diffuser plate is correctly placed and engaged, as this is essential for the sterilization process.**

**Note:** The trays, the tray holder and the steam diffuser plate may also be cleaned in a washer disinfectant.

## CLEANING THE CHAMBER FILTER

Proceed as follows:

- 1** Allow the sterilization chamber to cool down.
- 2** Empty the sterilizer chamber by removing the trays and the rack.
- 3** Turn the filter cap at the back of the chamber (bottom/center) counter-clockwise.

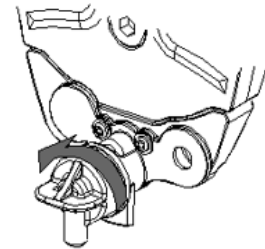
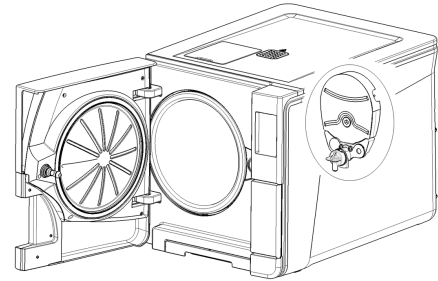

- 4 Remove the filter cap and the cartridge filter.
- 5 Rinse the cartridge filter with tap water.

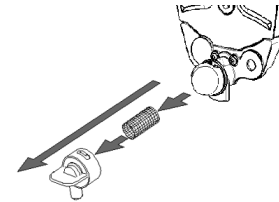

- 6 Insert the cartridge filter in the filter cap.

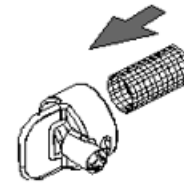

- 7 Insert the filter cap with the cartridge filter in its original position.

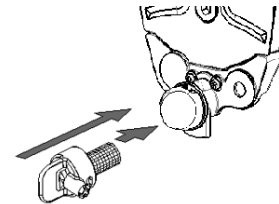

- 8 Lock the filter cap by turning it clockwise.

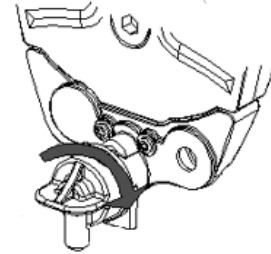

## CLEANING THE EXTERNAL SURFACES OF THE STERILIZER

Proceed as follows:

- 1 Clean all external sterilizer covers with a slightly damp cloth moistened with water.  
**Notice:** Never use disinfectants, detergents or abrasive products.

## 400-cycle maintenance

### REPLACING THE BACTERIOLOGICAL FILTER

**Notice:** If you replace this consumable before the maintenance due date you have to reset the cycle counter. See "Replace the consumable before the maintenance due date" on page 58.

Proceed as follows:

- 1** Open the service door.
- 2** Unscrew the bacteriological filter by hand (counter-clockwise).
- 3** Screw on the new bacteriological filter (clockwise) and tighten it snug.

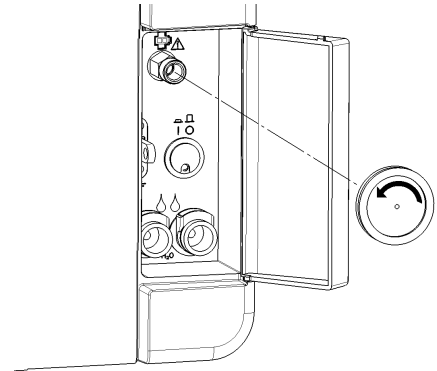



## REPLACING THE DUST FILTER

**Notice:** If you replace this consumable before the maintenance due date you have to reset the cycle counter. See "Replace the consumable before the maintenance due date" on page 58.

Proceed as follows:

- 1** Open the chamber door.
- 2** Pull out the dust filter handle from underneath the sterilizer.

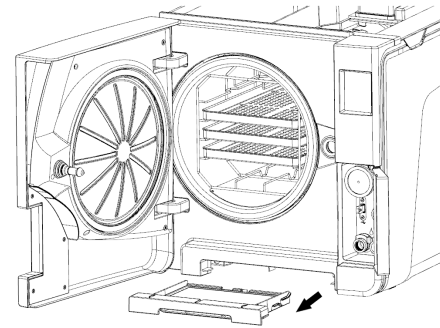

- 3** Lift the used filter from the handle and remove it.

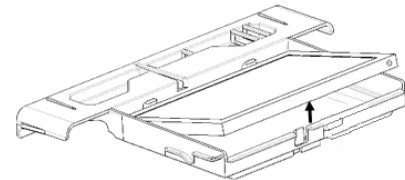

- 4 Insert the new filter into the handle.

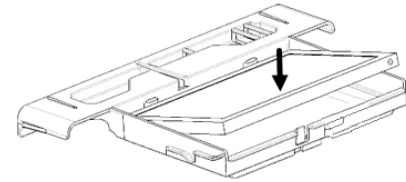

- 5 Slide the handle back into its original position.
- 6 Close the chamber door.

## 800-cycle or biannual maintenance

### SEQUENCE OF PROCEDURES TO CLEAN THE WATER TANKS

To clean the water tanks, proceed as follows:

- 1 "Prepare the sterilizer for cleaning the water tanks" on the next page.
- 2 "Access to the water tanks" on the next page.
- 3 "Clean the water tanks" on page 69

## PREPARE THE STERILIZER FOR CLEANING THE WATER TANKS

Proceed as follows:

- 1** Switch OFF the sterilizer and disconnect the mains cable.
- 2** Completely drain both water tanks (see "Draining the used and clean water tank" on page 75).
- 3** To drain the detergent solution during the subsequent cleaning, leave the drain tube attached to the drain port of the tank you want to clean.

## ACCESS TO THE WATER TANKS

Proceed as follows:

- 1** Lift the water tank cover.

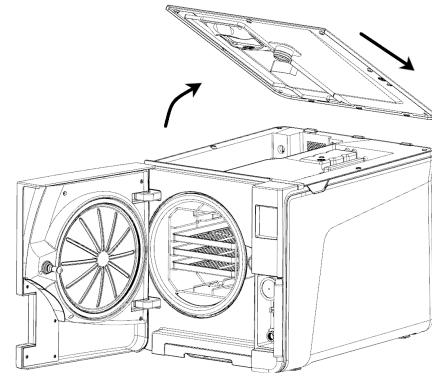

- 2** Remove the internal tank cover.
- 3** Clean and dry the internal tank cover and its rubber membrane to eliminate any condensate.

**Notice:** Never use disinfectants, strong detergents or abrasive products. Use a slightly damp cloth moistened with water.

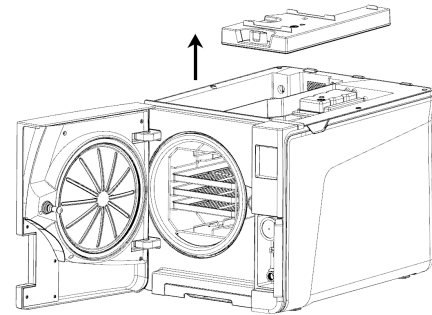

## CLEAN THE WATER TANKS

**Notice:** Do not touch the water level sensors. If misplaced or misaligned from their original position, the operation of the sterilizer could be impaired.

Proceed as follows:

- 1** Clean the internal tank surfaces with a soft sponge and a mild detergent solution.  
**Notice:** Never use disinfectants, strong detergents or abrasive products. Use a small non-abrasive brush to clean the areas that are difficult to reach.
- 2** Rinse the internal tank surfaces.
- 3** Wait until the drain tube has drained all the detergent solution and dry the internal tank surfaces.
- 4** Detach the drain tube, attach it to the drain port of the other tank and repeat steps 1, 2, 3.

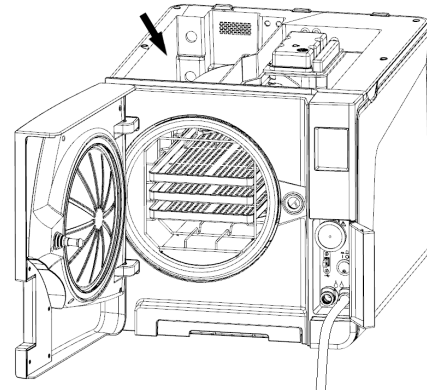

- 5** Remove the internal filters.
- 6** Clean the metal cartridges of the internal filters with tap water.
- 7** Reposition the internal filters.

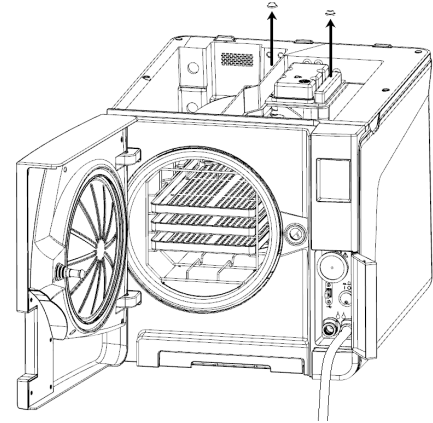

- 8 Reposition the internal tank cover and then the water tank cover.
- 9 Detach the drain tube.

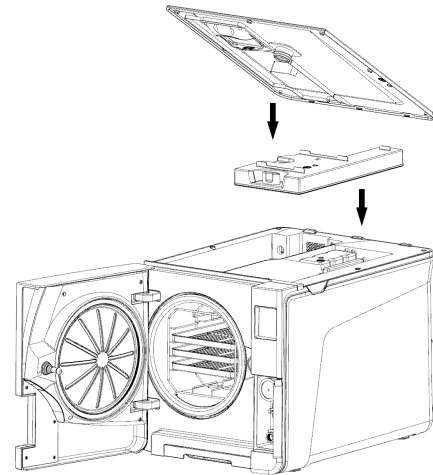

## 800-cycle maintenance

### REPLACING THE DOOR GASKET

**Notice:** If you replace this consumable before the maintenance due date you have to reset the cycle counter. See "Replace the consumable before the maintenance due date" on page 58.

Proceed as follows:

- 1** Fully open the chamber door.
- 2** Remove the used door gasket by hand.
- 3** Carefully clean the seal seat and the chamber face side with a damp, lint-free cloth.
- 4** Moisten the new seal with water to facilitate its placement.

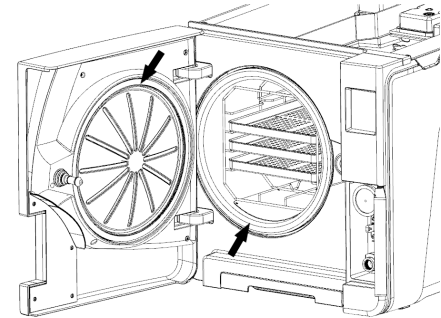



**5** Insert the new seal and press first up and down.

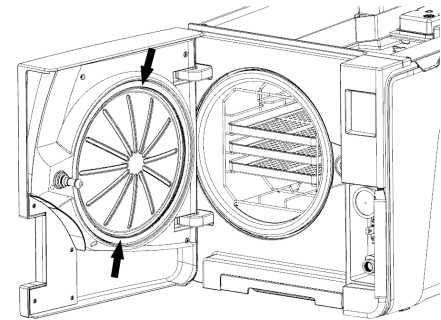

**6** Press left and right and then the entire seal circumference to ensure its perfect placement.

**Notice:** A steam discharge can damage the sterilizer plastic parts. Ensure the seal does not stick out.

**7** Wipe any residual water and run a Vacuum and Helix test to check for perfect tightness of the seal. See "Vacuum test" on page 42 and "Helix test" on page 40.

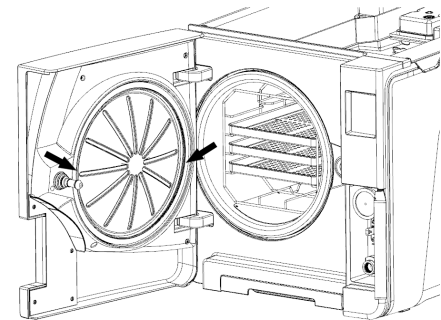

## 4000 cycle or five-year maintenance

### GENERAL CHECK AND SERVICE REQUIRED

**Notice:** Regular service is imperative to ensure continuous and effective operation of the sterilizer.

A general check and service should be carried out every 4000 cycles or five years by an authorized service technician. The service required includes the following:

- the replacement of consumables and other important internal components
- a check of the entire sterilizer with special care for the safety systems
- the cleaning of areas and components that cannot be accessed by the user.

### ACTIONS REQUIRED FOR EACH ELEMENT

For each element, the actions to be carried out are the following:

Element	Replace	Clean	Check
Solenoid valves	x	-	-
Vacuum pump internal parts	x	-	-
Sterilization chamber and external surfaces	-	x	-
Chamber filter	-	x	-

Element	Replace	Clean	Check
Internal parts, with particular care for the condenser fins and the main board	-	x	-
Steam diffuser plate	-	x	-
Pneumatic connections	-	-	x
Electrical connections	-	-	x
Temperature and pressure calibration	-	-	x
Door locking system	-	-	x
Pressure safety valve	-	-	x
Safety systems	-	-	x

## Extraordinary maintenance

### DRAINING THE USED AND CLEAN WATER TANK

If you left accidentally the tanks full for more than seven days or if you plan not to use the sterilizer for at least seven days, you have to drain the tanks.

- 1** Open the sterilizer service door.
- 2** Put a container below the sterilizer (5 l (1.3 gal) minimum) and place the end of the drain tube in it.
- 3** To drain the used water, insert the drain tube connector in the grey port.
- 4** To drain the clean water, insert the drain tube connector in the blue port.
- 5** When the water has been completely drained, press the release button to remove the drain tube and close the service door.

# Disposal

## DISPOSAL RESPONSIBILITY



- Separate the various components according to the materials they are made of.
- Drop the sterilizer with a company that specializes on the recycling of related products.
- Do not abandon the sterilizer in unsecured places.
- Always refer to current/applicable laws and rules in the country of use.

The same instructions apply to disposal of all used consumable parts.

## MATERIALS

The sterilizer is mainly built from fiber-reinforced polymers, metals and electric / electronic components.

# Diagnostics

## CONTENTS

This section deals with the following subjects:

Errors .....	77
Troubleshooting .....	82
Emergency door opening .....	88

## Errors

### CHECKS AND ACTIONS

**Notice:** For any error not listed in this table, call technical service.

Code	Description	Actions
<b>0xx</b>	Load cannot be considered sterile. See "End of a sterilization cycle" on page 51	Repeat the cycle.
	Check if the mains switch or network circuit breaker is OFF.	If the problem persists, call service.
	Check if the mains cable is properly connected.	
	Switch the sterilizer OFF and ON.	
	Set date and time, then switch the sterilizer OFF and ON.	
	Check the dust filter and ensure that the sterilizer fan is not blocked.	
<b>10x</b>	See error "13x to 16x" on the next page.	Repeat the cycle. If the problem persists, call service.

Code	Description	Actions
<b>12x</b>	Wait before opening the chamber door. Allow the sterilization chamber to cool down. See error "13x to 16x" below.	Repeat the cycle. If the problem persists, call service.
<b>13x to 16x</b>	Check water level in the clean water tank. Reset the safety thermostat..	Repeat the cycle. If the problem persists, call service.
	Switch the sterilizer OFF and ON.	
	Clean the door gasket and the chamber face side.	
	Check if the load placed in the sterilization chamber complies with the MAXIMUM WEIGHT LIMITS.	
	Clean the chamber and the chamber furniture from residuals of detergents, disinfectants and other chemicals. Replace the clean water if it is suspected to be contaminated with chemicals. Ensure all the load is clean rinsed and free from any chemicals before sterilizing.	
	Start a vacuum test to check the tightness of the pneumatic circuit.	
<b>18x</b>	Chamber filter clogged. Remove and clean the chamber filter. See error "13x to 16x" above.	Repeat the cycle. If the problem persists, call service.
	Bacteriological filter clogged. Check and replace if necessary.	
<b>19x</b>	Clean the door gasket and the chamber face side.	Repeat the cycle. If the problem persists, call service.
<b>2xx</b>	Switch the sterilizer OFF and ON.	Repeat the cycle. If the problem persists, call service.
	Wait for the chamber to cool down. Reset the safety thermostat (see "Extraordinary maintenance" on page 75).	

Code	Description	Actions
<b>3xx</b>	Check the door gasket. Clean or replace it if necessary.	Repeat the cycle. If the problem persists, call service.
	Clean the chamber face side.	
	Clean the chamber filter.	
	Check if chamber filter is properly locked in the cap.	
	Check the load does not exceed the MAXIMUM WEIGHT LIMITS.	
<b>4xx</b>	Clean water error (bad quality or low water level). Drain and refill the clean water tank.	Repeat the cycle. If the problem persists, call service.
<b>5xx</b>	Check if there are hurdles on the door locking area (chamber rack, loads, objects, ...).	Repeat the cycle. If the problem persists, call service.
	Check the door gasket (wrong placed).	
	Check if the door can move freely without touching the trays or the load when closing.	
	Switch the sterilizer OFF and ON.	
<b>990</b>	The cycle has been aborted by the user.	Re-process the load.



## MESSAGES AND ALERTS

**Notice:** For any error not listed in this table, call technical service.

Message/Alert	Description	Action
<b>Fill clean water tank.</b>	There is not enough water in the tank to perform a cycle.	Fill the water tank as requested.
<b>Drain used water tank.</b>	The used water tank is full.	Drain the water tank as requested.
<b>Please close the door.</b>	The door must be locked, but you didn't close it.	Close the door so it can be locked.

Message/Alert	Description	Action
<b>Non-conform water</b>	The clean water quality is bad (conductivity between 15 and 50 $\mu\text{S}/\text{cm}$ ).	You may run a cycle but the water must be replaced soon, otherwise the unit will automatically lock-out to prevent damage.
<b>Unacceptable water</b>	The clean water quality is very bad (conductivity more than 50 $\mu\text{S}/\text{cm}$ ).	Running a cycle is inhibited to prevent damage. Replace the clean water.
<b>Door Gasket must be replaced in ... cycles. Have you ordered the Door Gasket?</b>	These are pre-alerts advising that one of the consumables has to be replaced within a small number of cycles.	Tap <input checked="" type="checkbox"/> if you have the consumable available for replacement. Tap <input type="checkbox"/> if you don't have the consumable in stock and must order one. In this case, the pre-alert will appear again after some cycles. See "Maintenance" on page 57.
<b>Bact. Filter must be replaced in ... cycles. Have you ordered the Bact. filter?</b>		
<b>Dust Filter must be replaced in ... cycles. Have you ordered the Dust filter?</b>		
<b>4000 cycle maintenance must be performed in ... cycles. Have you already booked the 4000 cycle service?</b>		
<b>Possible leak detected. Please run Vacuum Test.</b>	Air was detected in the chamber: a vacuum leak is suspected. The cycle was completed but a vacuum test is required.	Run a vacuum test. Call for service if an anomaly is detected.
<b>Remote data storage Please check settings.</b>	Error when saving the files in the network.	Check the settings, the network resource and the memory space available on it.
<b>Remote data storage File lost.</b>	Some cycle reports couldn't be saved in the network because the sterilizer memory is limited (see "Sterilization cycle report" on page 52).	No action possible. The cycles were overwritten in the sterilizer database before being saved, and there is no way to recover them.



Message/Alert	Description	Action
<b>Door Gasket replacement is due.</b> <b>Have you replaced the door gasket?</b>	These messages advise that one consumable must be replaced.	Replace the consumable and tap  to reset the counter [See "Maintenance" on page 57]. If you don't replace the consumable, press  . In this case, you may still use the sterilizer but the message will appear again after some cycles.  <b>CAUTION!</b> Operating the sterilizer with expired consumables could be dangerous and could damage the sterilizer.
<b>Bact. Filter replacement is due..</b> <b>Have you replaced the bacteriological filter?</b>		
<b>Dust Filter replacement is due.</b> <b>Have you replaced the dust filter?</b>		
<b>4000 cycle service</b> <b>Please call your technical support to organize service.</b>	This message advises you that the target of 4000 cycles has been achieved and the relevant maintenance step is to be performed.	Call technical service for the 4000 cycle maintenance.

# Troubleshooting

## MANAGING ERRORS

If during a sterilization cycle an error occurs do the following:

- 1 Wait until the end of the reset phase.



**CAUTION!** Do not switch off the sterilizer during the reset phase: it takes some minutes to reset the system and reach safe conditions in the sterilizer chamber.

- 2 When the **OPEN** button appears, tap it to unlock the door.
- 3 Confirm the opening of the door.

**Notice:** Water could be present in the chamber when opening the door: prevent spilling (e.g., place a towel below the chamber door).

## VIEW AND SAVE THE ERROR LOG

- 1 On the homepage tap > > : a list of the last errors appears.
- 2 Tap to save the list in the USB pen drive.

## ERROR PAGE

During the sterilization cycle, the sterilizer is continuously monitored by a control system. If an anomaly is detected, the cycle is aborted automatically, and the sterilizer starts a reset phase.

The following page appears:

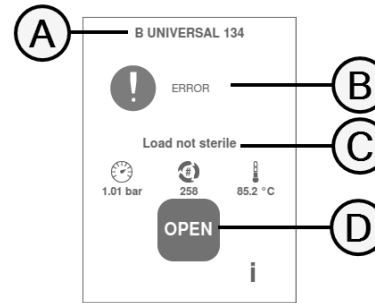

Part	Description
A	Current sterilization cycle
B	Error number, See "Errors" on page ??.
C	Warning messages.
D	Open button that appears after the reset phase had finished.

## WARNING MESSAGES

Message	Description
Load not sterile	The load is not sterile. <b>WARNING! Do not use items on patients!</b>
Drying interrupted	The load might be wet. <b>WARNING! Wet items are for immediate use only!</b>

## RESET THE SAFETY THERMOSTAT

The sterilizer is fitted with a safety thermostat to prevent it from overheating. If the safety thermostat operates because of too high temperatures, the error 240 or a timeout error is displayed. The thermostat must be reset manually. Proceed as follows:

- 1** Switch the sterilizer OFF and remove the mains cable.
- 2** Wait for the sterilizer to cool down.
- 3** Open the chamber door.
- 4** Remove the dust filter and move the sterilizer closer to the shelf edge.
- 5** Push the reset button of the thermostat switch: a click sound indicates that the thermostat switch has been reset.
- 6** Insert the dust filter back into its original position.

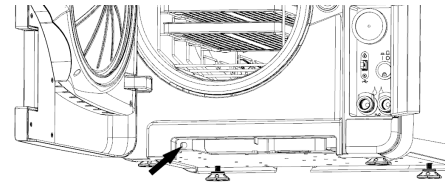
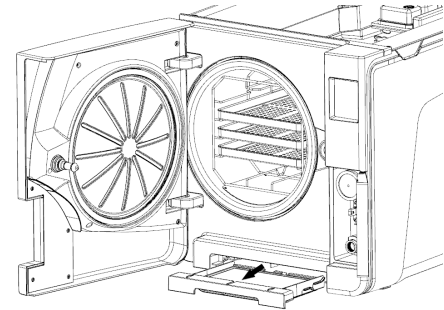

- 7** Close the chamber door.
- 8** Connect the mains cable and place the sterilizer back into its original position.
- 9** Switch the sterilizer ON.
- 10** Wait for the sterilizer to finish the error reset phase and follow the instructions on the display.

**Note:** If the thermostat operates repeatedly, call technical service.

## TROUBLESHOOTING TABLE

**Note:** If your problem is not resolved, call your authorized service provider.

**Notice:** Before sending the sterilizer for technical service, remove the mains cable, empty both water tanks and use the original or appropriate packaging.

Problem	Possible cause	Solutions
The sterilizer remains switched OFF.	The mains switch or network circuit breaker is OFF.	Activate the mains switch or network circuit breaker (ON).
	No voltage at the socket.	Check the electric circuit.
	The power cord is not connected properly.	Check and connect the power cord properly.
Water is leaking at the front of the sterilizer.	Leaks through the chamber door gasket.	Clean or replace the door gasket. Clean the chamber face side.
	Internal leak.	Call technical service.
The cycle commences but there is no pressure/temperature rise.	The safety thermostat switch is open.	Reset the safety thermostat switch. See "Extraordinary maintenance" on page 75.
	Electric - electronic fault.	Call technical service.
At the end of the cycle, there is residual water in the chamber.	Sterilizer not properly leveled.	Properly level the surface the sterilizer is placed on.
	Overloaded chamber.	Comply with the maximum load weight limits for each type of load. Always use the chamber rack for trays and cassettes. See "Load maintenance and preparation" on page 44
	Chamber filter clogged.	Remove and clean the chamber filter.
	Chamber filter cap not well-positioned.	Mount the chamber filter cap properly (see "Ordinary maintenance" on page 57)
	Load incorrectly placed.	See "Load maintenance and preparation" on page 44

Problem	Possible cause	Solutions
Corrosion or spots on instruments.	Tap water on instruments when placed in the sterilizer.	Ensure that instruments are dry before they are placed in the sterilizer.
	Use of water of poor quality or water containing chemical substances.	Drain both water tanks. Use water of good quality. See "Water quality" on page 102.
	Organic or chemical residues on the instruments.	Clean, rinse and dry instruments before placing them in the sterilizer. See "Load maintenance and preparation" on page 44
	Chamber, trays, chamber rack dirty.	Clean the chamber and wash the chamber furniture.
	Contact between instruments of different materials.	Ensure that instruments of different materials do not touch (aluminum, carbon or stainless steel, etc.); place them on different trays or cassettes or pouch them. See "Load maintenance and preparation" on page 44
	Scale deposits on the chamber.	Clean the chamber and use water of good quality. See "Water quality" on page 102.
Instruments are turning brown or black.	Incorrect temperature selected.	Select a sterilization cycle featuring a lower sterilization temperature. Follow the instructions of the instrument manufacturer.
The cycle report printer does not work.	Printer not properly connected or not powered.	Check the data and the power connection to the printer.
No cycles are stored in the cycle history menu.	An electronic board was replaced by service.	None. The memory of the old board cannot be restored. Save periodically the history on the USB pen drive.
When starting a cycle, the chamber door locks but re-opens immediately. The "Open the door" message appears.	Door gasket not properly placed; seal sticking out.	Ensure that the door gasket is evenly inserted on the entire circumference.
	Door jammed by external objects or by the load itself.	Remove any objects interfering with the chamber door. Check the door does not force against the load or the chamber furniture.

Problem	Possible cause	Solutions
When the sterilizer is connected to an automated water supply system: there is no clean water in the tank, but the automatic water filling does not fill the water	Water fill system not connected.	Connect the water fill system to the sterilizer. See "Water quality" on page 102.
	When the water fill system attempted to fill the tank, water was temporarily unavailable.	Since water tank filling is attempted only once in-between cycle execution, this event inhibits water feeding. Switch the sterilizer OFF and then ON again. Check the external water supply system. Check for water leaks from the sterilizer.
	Faulty MIN water level sensor in the clean water tank.	Call service.
The sterilizer enters into standby mode immediately after opening the chamber door.	The chamber door has not been opened after the previous cycle had finished and the standby mode delay has expired.	Press the standby button to exit.
At the end of the cycle the display reads "Open the door" but opening the door is impossible.	The chamber is in vacuum due to an internal malfunction.	See "Emergency door opening" on the next page. Switch the sterilizer OFF: this releases any internal pressures allowing the chamber door to be opened. Call technical service if the problem persists.
	The bacteriological filter is blocked.	Remove the bacteriological filter to get the pressure released. Replace the filter. <b>Note:</b> The bacteriological filters need to be replaced every 400 cycles.
The sterilization process phase of a sterilization cycle was longer than expected.	The chamber temperature dropped below the minimum threshold and the software performed a successful recovery.	Wait for cycle completion. If the problem occurs frequently, call technical service.
Warning about USB saving (HTML and SCL files).	The USB pen drive is not connected or not properly connected to the sterilizer.	Check presence and connection of the USB pen drive. If the problem persists, call service.
Warning about programmed maintenance.	A component shall be replaced for the programmed maintenance of the sterilizer.	Call service to order the requested component (door gasket, dust filter, bacteriological filter... ). See "Ordinary maintenance" on page 57

## Emergency door opening

### WARNING ABOUT OPENING THE DOOR IN EMERGENCY



**WARNING!** High pressure. Risk of explosion, jet of hot steam, sudden opening of the door. Carry out the following procedure only if necessary and only when **NO RESIDUAL PRESSURE IS IN THE CHAMBER**. Any attempt to open the door while the unit is still hot or under pressure could expose the operator and the surrounding personnel to serious risk.



**CAUTION!** High temperature. Risk of burns. Carry out the following procedure only when the sterilizer has completely cooled down. The sterilizer should be unplugged from the mains power supply for at least 3 hours before executing this procedure.

**Notice:** Carry out this procedure only as indicated and with the sterilizer in the indicated conditions. Any attempt to open the door in a different way can seriously damage the sterilizer.

### OPENING TOOL

The door locking system is electrically activated. In case the door remains locked due to a black-out or an electric fault, an auxiliary unlocking procedure is available.

For this reason, two 9V batteries size PP3 or 1604 are required.



## OPEN THE DOOR IN EMERGENCY

- 1** Unplug the sterilizer and wait at least three hours.
- 2** Take the emergency door opening tool included in the sterilizer box.
- 3** Firmly open the service door.
- 4** Unscrew the bacteriological filter by hand (counter-clockwise).

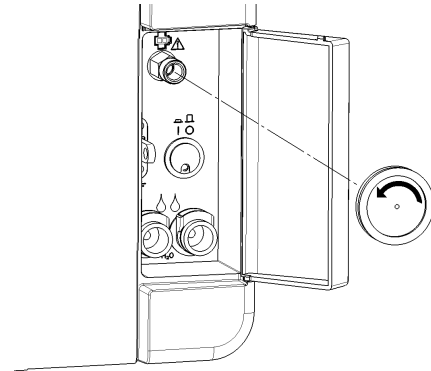

- 5** Plug two batteries into the connectors.
- 6** Holding the service door pulled, plug the plastic connector into the socket behind the bacteriological filter.
- 7** As soon as the door opens, unplug the plastic connector to prevent system overload and consequent damage.

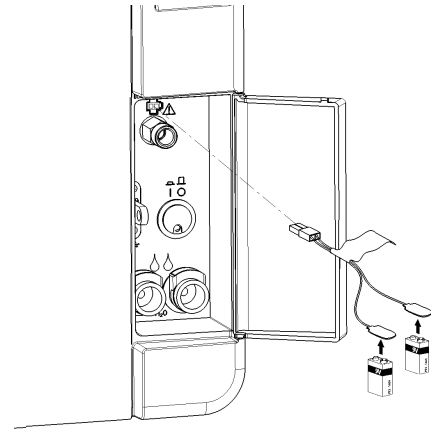

# Technical data

## CONTENTS

This section deals with the following subjects:

Sterilization cycles .....	91
Sterilization cycle phases .....	95
Technical data .....	98
Recommendations for validation .....	100
Diagrams .....	101
Water quality .....	102
Accessories, spare parts, consumables .....	103
Authorized W&H service partners .....	109

## Sterilization cycles

### WARNINGS

For your safety and for the safety of your patients:



#### **WARNING!**

**Never process objects different from those specified in the cycle program table and never exceed the maximum load weight limits specified in it as this could impair the sterilization process. Such actions could result in non-sterile conditions at the end of the cycle, could expose people to the hazard of cross-infections, are considered as an improper use of the sterilizer for which the manufacturer cannot be hold responsible.**

**All indications of sterile load or successful completion of the cycle that are given on the display at the end of the cycle are not valid if the type and quantity of the load are not complied with.**

**Processing bagged items with the S Naked 134 cycle will result in wet bags/pouches at the end of the cycle, exposing the items to contamination due to improper storage. The display reminds the maximum permitted load before starting a cycle.**

## STANDARD STERILIZATION CYCLES AVAILABLE

There are four sterilization cycles available, all of them complying with the European Standard EN13060:

- three B-type cycles
- one S-type cycle (optional, activated with S Naked cycle activation code. See "S Naked 134 cycle activation" on page 48)

Cycle type	Cycle name	Purpose
B	<b>B Universal 134</b>	For all your general items like hand instruments, handpieces, forceps, etc.
	<b>B Extended 134</b>	Features an extended sterilization time, if this is required for your load or mandated in your country.
	<b>B Universal 121</b>	For all items that cannot withstand the high temperatures of the 134 cycles, such as textiles and plastics.
S	<b>S Naked 134 (optional)</b>	For fast processing of unwrapped instruments only, including dental turbines and handpieces, solid and hollow B (simple hollow items). It is not suitable for textiles, porous or bagged/wrapped items. The instruments sterilized with this cycle cannot be stored: they must be used immediately after being sterilized.

## COMMON STERILIZATION CYCLE DATA

	Sterilization cycles			
	B Universal 134	B Extended 134	B Universal 121	S Naked 134 (optional)
<b>Sterilization temperature</b>	134 °C (273 °F)	134 °C (273 °F)	121 °C (250 °F)	134 °C (273 °F)
<b>Sterilization pressure</b>	3.03 bar 2.03 bar (g)	3.03 bar 2.03 bar (g)	2.04 bar 1.04 bar (g)	3.03 bar 2.03 bar (g)
<b>Duration of the Plateau/Sterilization phase</b>	4'	18' 30"	20' 30"	4'

Sterilization cycles				
	B Universal 134	B Extended 134	B Universal 121	S Naked 134 (optional)
Minimum duration of the drying phase (set by the user)	25'	25'	30'	7'
Load type	All unwrapped, bagged, single/double wrapped items: <ul style="list-style-type: none"> <li>■ Solid</li> <li>■ Hollow A (Narrow lumen)</li> <li>■ Hollow B (simple hollow item)</li> <li>■ Porous</li> </ul>			Unwrapped items: <ul style="list-style-type: none"> <li>■ Solid</li> <li>■ Hollow B (simple hollow item)</li> <li>■ Dental load (turbines and handpieces family ...)</li> </ul>

### TOTAL CYCLE DURATION

The total cycle time includes the drying time and may vary according to different elements, such as the following:

- type of load (solid or porous)
- load weight
- other factors

Values and cycle names could be different depending on country requirements.

	Load							
	Empty		Full		Typical (2.5 kg)		Eco (0.5 kg)	
	LINA 17	LINA 22	LINA 17	LINA 22	LINA 17	LINA 22	LINA 17	LINA 22
<b>B Universal 134</b>	43'30"	46'30"	49'30"	52'30"	45'30"	48'30"	25'30"	28'30"
<b>B Extended 134</b>	58'	61'	64'	67'	60'	63'	40'	43'
<b>B Universal 121</b>	63'	65'	71'	74'	67'	69'	-	-
<b>S Naked 134 (optional)</b>	20'	21'	26'	27'	23'	24'	-	-

**Note:** Values and cycle names could be different depending on country requirements.

## MAXIMUM LOAD FOR INSTRUMENTS

**Note:** The load given includes the trays, the containers and everything is put into the chamber, with the sole exclusion of the tray rack.

	Instruments					
	Bagged		Unwrapped		Porous	
	LINA 17	LINA 22	LINA 17	LINA 22	LINA 17	LINA 22
<b>B Universal 134</b>	3.5/5.5 kg <sup>1</sup>	4.0/6.0 kg <sup>2</sup>	3.5/5.5 kg <sup>1</sup>	4.0/6.0 kg <sup>2</sup>	0.5/1.5 kg <sup>3</sup>	0.5/2.0 kg <sup>4</sup>
<b>B Universal 134 ECO mode</b>	0.5 kg	0.5 kg	0.5 kg	0.5 kg	0.5 kg	0.5 kg
<b>B Extended 134</b>	3.5/5.5 kg <sup>1</sup>	4.0/6.0 kg <sup>2</sup>	3.5/5.5 kg <sup>1</sup>	4.0/6.0 kg <sup>2</sup>	0.5/1.5 kg <sup>3</sup>	0.5/2.0 kg <sup>4</sup>
<b>B Extended 134 ECO mode</b>	0.5 kg	0.5 kg	0.5 kg	0.5 kg	0.5 kg	0.5 kg
<b>B Universal 121</b>	3.5/5.5 kg <sup>1</sup>	4.0/6.0 kg <sup>2</sup>	3.5/5.5 kg <sup>1</sup>	4.0/6.0 kg <sup>2</sup>	0.5/1.5 kg <sup>3</sup>	0.5/2.0 kg <sup>4</sup>
<b>S Naked 134 (optional)</b>	-	-	4.0 kg	4.0 kg	-	-

**Note 1:** Duration reported in the table refers to 3.5 kg. It is possible to sterilize up to 5.5 kg by drying time extension.

**Note 2:** Duration reported in the table refers to 4.0 kg. It is possible to sterilize up to 6.0 kg by drying time extension.

**Note 3:** Duration reported in the table refers to 0.5 kg. It is possible to sterilize up to 1.5 kg by drying time extension.

**Note 4:** Duration reported in the table refers to 0.5 kg. It is possible to sterilize up to 2.0 kg by drying time extension.



**WARNING! Never exceed the maximum load weight limits as specified in the table as this could impair the sterilization process.**

## Sterilization cycle phases

### COMMON LEGEND OF THE STERILIZATION CYCLE PHASES

Following is the description of the sterilization phases.

Code	Description
PHE	Pre-heating of the sterilizer. This phase is not considered a part of the cycle.
HEA	Heating phase (heat the chamber and the load)
PV1 - PV2	Vacuum pulse (removal of air from the sterilizer chamber/load)
PP1 - PP2	Pressure pulse (steam generation)
PPH	Rise to the Plateau/Sterilization phase
PR	Process (Plateau/Sterilization phase)
DRY	Vacuum drying
LEV	Leveling. Pressure inside the sterilization chamber is leveled to the atmospheric pressure.
END	End of the cycle

## TYPE B STERILIZATION CYCLE PHASES

All type B sterilization cycles feature the same basic pressure profile as shown in the graph below. The duration and the temperature sterilization phase differ between the various cycles.

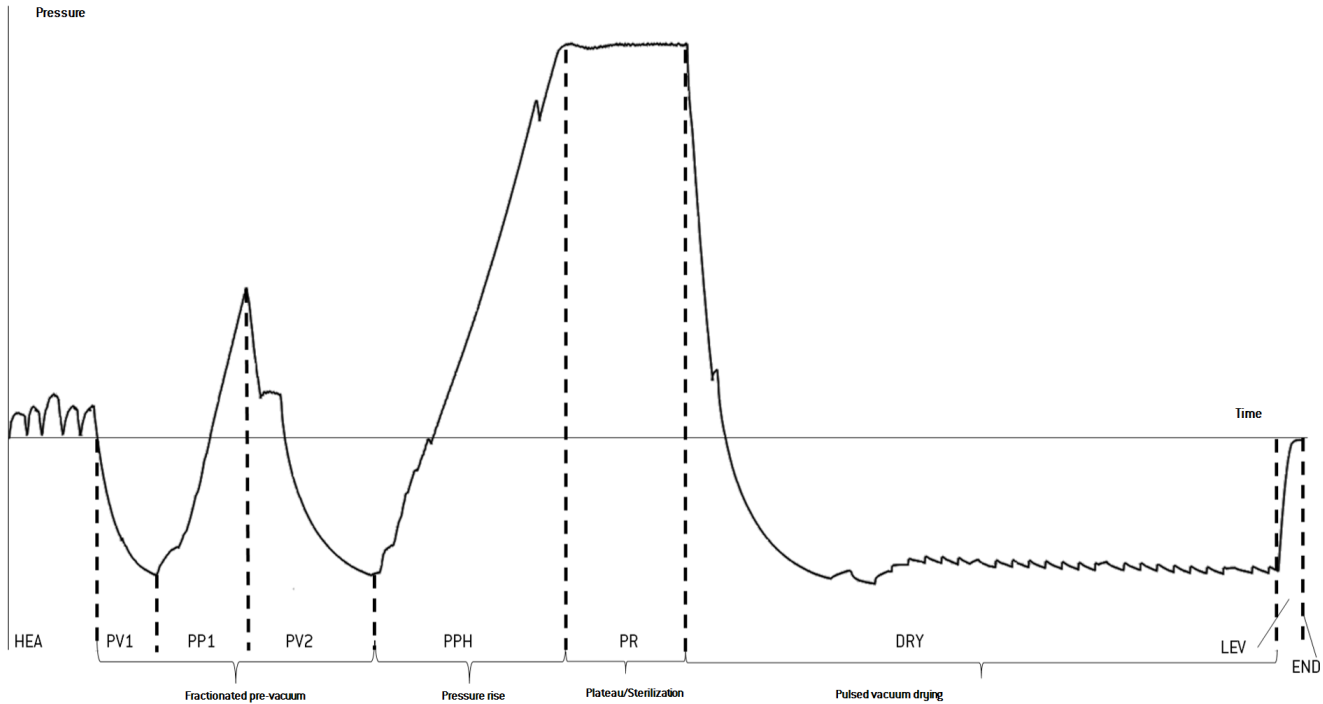



## TYPE S STERILIZATION CYCLE PHASES

The S Naked 134 cycle is specifically designed to sterilize unwrapped instruments, for immediate use on patients, not requiring a complete drying. Thus, the drying phase of this cycle is short and not assisted by vacuum, making this cycle the fastest available.

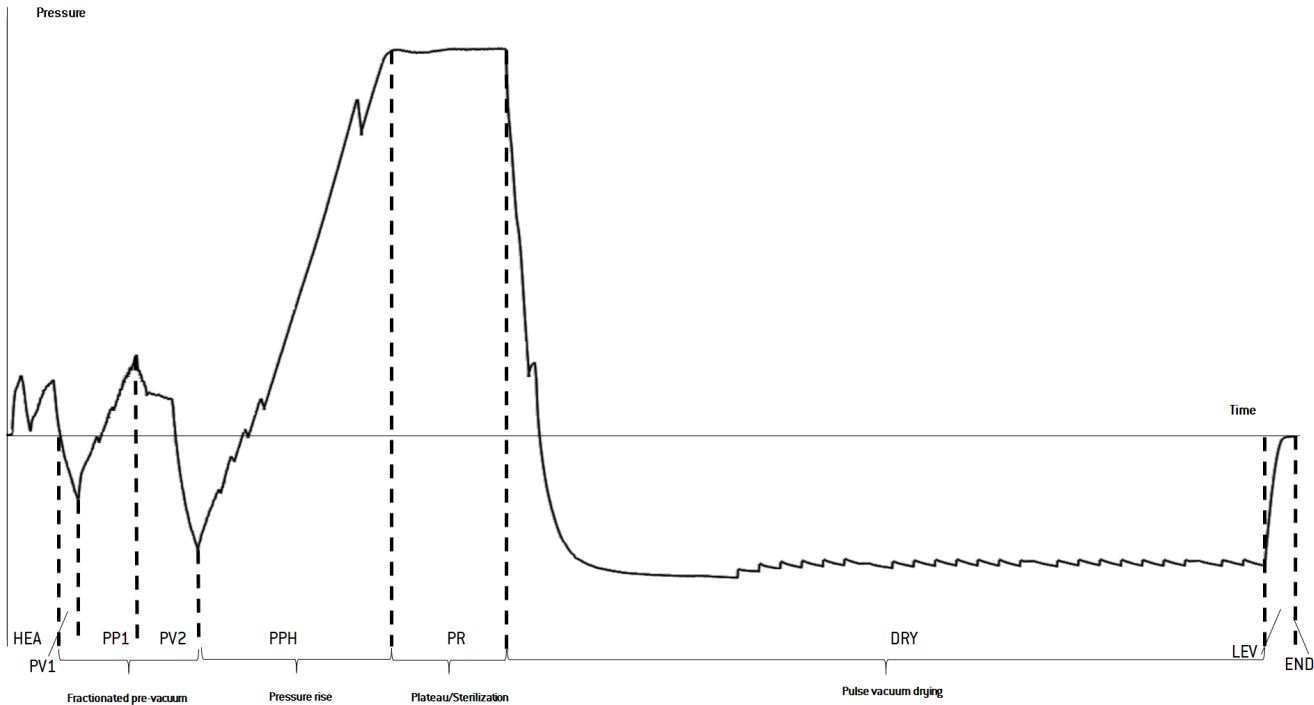

# Technical data

## WATER SUPPLY SYSTEM

<b>Temperature</b>	max. 35 °C (95 °F)
<b>Pressure</b>	min. 2 bar – max. 8.6 bar (min 29 psi - max. 124.7 psi)
<b>Flow</b>	min. 0.25 – max. 0.5 l/min (min. 0.066 - max. 0.132 gal/min)

## POWER SUPPLY SYSTEM

<b>Nominal voltage and Max. current</b>	200–240 V ac (±10%), 50 Hz, 10 A, single-phase 200–240 V ac (±10%), 60 Hz, 10 A, single-phase
<b>Overvoltage category</b>	II
<b>Protection required</b>	Suitable circuit breaker and a Ground Fault Circuit Interrupter (GFCI). All protection devices must be certified according to applicable standard. A grounded connection is essential.
<b>Communication with other devices</b>	1 USB port in the front 1 USB port at the rear (optional)
<b>Features</b>	Fully micro-processor controlled, process evaluation system according to EN13060. Programmable standby mode.
<b>Max. heat output</b>	3000 kJ/h

## INSTALLATION REQUIREMENTS

<b>Working temperature</b>	From +5 °C to +40 °C (from +41 °F to +104 °F)
<b>Working relative humidity</b>	Max. RH 80% up to 31 °C (88 °F), linearly decreasing to 50% at 40 °C (104 °F)

<b>Storage temperature / rel. humidity</b>	From -20 °C to +60 °C (from -4 °F to +140 °F)/0–90 % (with empty tanks)
<b>Max altitude</b>	3000 m asl
<b>Min. atmospheric pressure</b>	0.6 bar (8.7 psi)
<b>Overall dimensions</b>	W: 465 mm/H: 452 mm/D: 646 mm (W: 18.3"/H: 17.8"/D: 25.4")
<b>Min. space required</b>	W: 485 mm/H:502 mm/D:439 mm (W: 19,1"/H: 19,8"/D: 17,3")
<b>Size of the door movement</b>	W: 532 mm/H: 443 mm/D: 357 mm (W: 21"/H: 17,5"/D: 14")
<b>Weight empty</b>	LINA 17: 40 kg (88.2 lbs) LINA 22: 42 kg (92.6 lbs)
<b>Max. weight (fully loaded)</b>	LINA 17: 54 kg (119 lbs) LINA 22: 56.5 kg (124.6 lbs)
<b>Weight per support area</b>	LINA 17: 32 kN/m <sup>2</sup> LINA 22: 33.5 kN/m <sup>2</sup>
<b>Environment pollution</b>	Degree 2
<b>Usage environment</b>	Indoor

## STERILIZER CHAMBER

<b>Pressure safety valve</b>	2.6 bar (37.7 psi)
<b>Safety thermostats</b>	180 °C (356 °F)
<b>Total volume</b>	LINA 17: 17 l/0: 250 mm/D: 362 mm (4.5 gal, 0: 9.8"/D: 14") LINA 22: 22 l/0: 250 mm/D: 440 mm (5.8 gal, 0: 9.8"/D: 17")
<b>Usable space *</b>	LINA 17: W: 195 mm/H: 195 mm/D: 312 mm (W: 7.7"/H: 7.7"/D: 11.7") LINA 22: W: 195 mm/H: 195 mm/D: 400 mm (W: 7.7"/H: 7.7"/D: 15.4")
<b>Bacteriological filter</b>	0.3 µm

**Note\*:** Usable space with standard rack and trays. With optional racks and

trays, see "Accessories, spare parts, consumables" on page 103.

## STEAM GENERATOR

<b>Pressure safety valve</b>	5 bar (72.51 psi)
------------------------------	-------------------

<b>Safety thermostats</b>	230 °C (446 °F)
---------------------------	-----------------

## DISTILLED OR DEMINERALIZED WATER

<b>Water quality</b>	Fulfilling EN 13060 Ann. C (conductivity: < 15µS/cm, Total Dissolved Solids: < 10 ppm)
----------------------	--

<b>Average water consumption</b>	0.5 to 0.66 litres/cycle (0.13 to 0.17 gal/cycle)
----------------------------------	---

<b>Tank volume</b>	Clean water 4.8 l (1.27 gal), 2.8 l (0.74 gal) with air gap Used water 4.8 l (1.27 gal)
--------------------	--

## Recommendations for validation



### TEST VALIDATION POINTS

LINA sterilizers can be validated in accordance to EN17665-1.

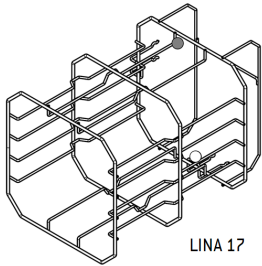
For further details please refer to the Qualification/Validation guide for sterilization cycles of the manufacturer.



LINA 17

Part	Description
	Hottest points
	Coldest points

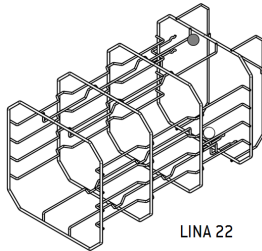

LINA 22

# Diagrams

## CONNECTION DIAGRAMS

Data communication

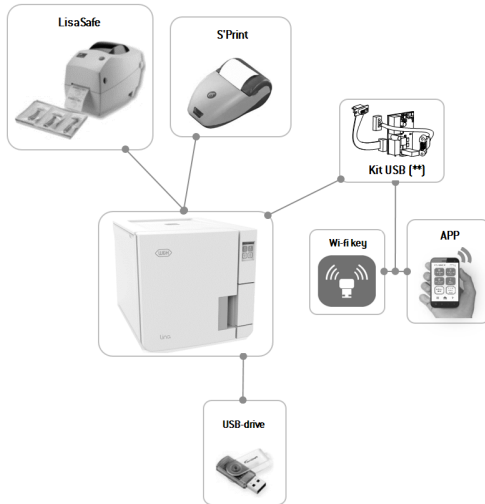

**Note (\*\*):** Rear serial connection.

Water system

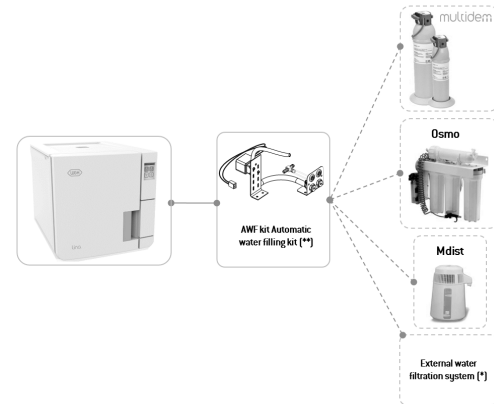

**Note (\*):** The water filtration system must be fitted with a backflow preventing device complying to IEC 61770 and to national and local regulations.

For water requirements see "Technical data" on page 98.

# Water quality

## FEED WATER SPECIFICATIONS (EN 13060)

**Notice:** Do not use rust inhibitor or any other agents in the clean water tank.

This sterilizer uses distilled or demineralized water to generate steam for the sterilization process. The table below lists the maximum content of minerals and the specifications for the water used for steam sterilization according to EN13060 ANNEX C.

Contaminants/minerals/qualities	Value/Specification
Total Dissolved Solids	< 10 mg/l
Silicon oxide, SiO <sub>2</sub>	< 1 mg/l
Iron	< 0.2 mg/l
Cadmium	< 0.005 mg/l
Lead	< 0.05 mg/l
Heavy metals (excl. iron, cadmium, lead)	< 0.1 mg/l
Chloride	< 2 mg/l
Phosphate	< 0.5 mg/l
Conductivity (at 20°C)	< 15 µS/cm
pH value	5–7



Contaminants/minerals/qualities	Value/Specification
Appearance	colorless, clean, free from sediment
Hardness	< 0.02 mmol/l
Chemical additives	<b>No chemicals or additives must be added to the water used for the steam sterilization process,</b> even if they are specifically claimed for use in steam generators, or for steam production, or as additives for sterilization, disinfection, cleaning or corrosion protection.



**Notice:**

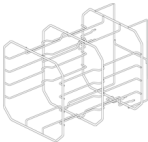

The use of water with a conductivity greater than 15µS/cm (10 ppm) may affect the sterilization process and damage the sterilizer. The use of water with a conductivity greater than 50µS/cm, or not complying with the specifications in the table above, may strongly affect the sterilization process and seriously damage the sterilizer. The manufacturer’s warranty is void if the sterilizer was used with water containing contaminant or chemical levels exceeding those listed in the table above.

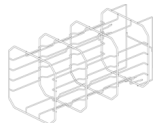

# Accessories, spare parts, consumables

## LIST OF ACCESSORIES AND SPARE PARTS

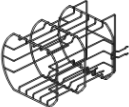

Picture	Part	Part number
	<p><b>Standard chamber rack for 5 aluminium trays for LINA 17</b></p> <p>Usable space - Cassette size (mm):</p> <ul style="list-style-type: none"> <li>■ 188 x 21 x 312</li> <li>■ 188 x 28 x 312</li> <li>■ 188 x 28 x 312</li> <li>■ 188 x 28 x 312</li> <li>■ 188 x 22 x 312</li> </ul>	 F523031X
	<p><b>Note:</b> rack rotated 90°.</p> <p><b>Standard chamber rack for 3 cassettes /containers* for LINA 17</b></p> <p>Usable space - Cassette size (mm):</p> <ul style="list-style-type: none"> <li>■ 190 x 50 x 312</li> <li>■ 190 x 50 x 312</li> <li>■ 190 x 50 x 312</li> </ul>	 F523031X

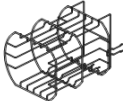

Picture	Part	Part number
	<p><b>Standard chamber rack for 5 aluminium trays for LINA 22</b></p> <p>Usable space - Cassette size (mm):</p> <ul style="list-style-type: none"> <li>■ 188 x 21 x 400</li> <li>■ 188 x 28 x 400</li> <li>■ 188 x 28 x 400</li> <li>■ 188 x 28 x 400</li> <li>■ 188 x 22 x 400</li> </ul>	 F523032X
	<p><b>Note:</b> rack rotated 90°.</p> <p><b>Standard chamber rack for 3 cassettes /containers* for LINA 22</b></p> <p>Usable space - Cassette size (mm):</p> <ul style="list-style-type: none"> <li>■ 190 x 50 x 400</li> <li>■ 190 x 50 x 400</li> <li>■ 190 x 50 x 400</li> </ul>	 F523032X

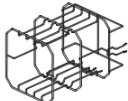

Picture	Part		Part number
	<p><b>Optional chamber rack for 3 cassettes /containers* for LINA 17</b></p> <p>Usable space - Cassette size (mm):</p> <ul style="list-style-type: none"> <li>■ 205 x 35 x 300</li> <li>■ 210 x 35 x 300</li> <li>■ 205 x 35 x 300</li> </ul>		F523020X
	<p><b>Optional chamber rack for 3 cassettes /containers* for LINA 22</b></p> <p>Usable space - Cassette size (mm):</p> <ul style="list-style-type: none"> <li>■ 205 x 35 x 380</li> <li>■ 210 x 35 x 380</li> <li>■ 205 x 35 x 380</li> </ul>		F523021X



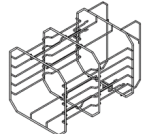

Picture	Part		Part number
	<p><b>Optional chamber rack for 4 cassettes/containers* for LINA 17</b></p> <p>Usable space - Cassette size (mm):</p> <ul style="list-style-type: none"> <li>■ 190 x 32 x 300</li> <li>■ 210 x 32 x 300</li> <li>■ 210 x 32 x 300</li> <li>■ 190 x 32 x 300</li> </ul>		F523012X
	<p><b>Optional chamber rack for 4 cassettes /containers* for LINA 22</b></p> <p>Usable space - Cassette size (mm):</p> <ul style="list-style-type: none"> <li>■ 190 x 32 x 380</li> <li>■ 210 x 32 x 380</li> <li>■ 210 x 32 x 380</li> <li>■ 190 x 32 x 380</li> </ul>		F523015X

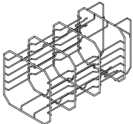



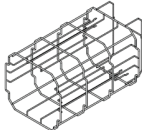

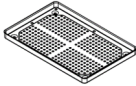
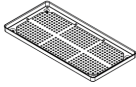



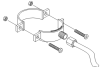



Picture	Part	Part number
	<p><b>Optional chamber rack for 2 cassettes /containers* for LINA 17</b></p> <p>Usable space - Cassette size (mm):</p> <ul style="list-style-type: none"> <li>■ 190 x 70 x 300</li> <li>■ 190 x 70 x 300</li> </ul>	 F523016X
	<p><b>Optional chamber rack for 2 cassettes /containers* for LINA 22</b></p> <p>Usable space - Cassette size (mm):</p> <ul style="list-style-type: none"> <li>■ 190 x 70 x 380</li> <li>■ 190 x 70 x 380</li> </ul>	 F523017X

Picture	Part	Part number
	<p><b>Optional chamber rack for 6 aluminium trays for LINA 17</b></p> <p>Usable space - Cassette size (mm):</p> <ul style="list-style-type: none"> <li>■ 188 x 19 x 312</li> <li>■ 188 x 21 x 312</li> <li>■ 188 x 21 x 312</li> <li>■ 188 x 21 x 312</li> <li>■ 188 x 21 x 312</li> </ul>	 F523033X
	<p><b>Note:</b> rack rotated 90°.</p> <p><b>Optional chamber rack for 3 cassettes /containers* for LINA 17</b></p> <p>Usable space - Cassette size (mm):</p> <ul style="list-style-type: none"> <li>■ 190 x 50 x 312</li> <li>■ 190 x 50 x 312</li> <li>■ 190 x 50 x 312</li> </ul>	

Picture	Part	Part number
	<p><b>Optional chamber rack for 6 aluminium trays for LINA 22</b></p> <p>Usable space - Cassette size (mm):</p> <ul style="list-style-type: none"> <li>■ 188 x 19 x 400</li> <li>■ 188 x 21 x 400</li> <li>■ 188 x 21 x 400</li> <li>■ 188 x 21 x 400</li> <li>■ 188 x 21 x 400</li> </ul>	 F523034X
	<p><b>Optional chamber rack for 3 cassettes /containers* for LINA 22</b></p> <p>Usable space - Cassette size (mm):</p> <ul style="list-style-type: none"> <li>■ 190 x 50 x 400</li> <li>■ 190 x 50 x 400</li> <li>■ 190 x 50 x 400</li> </ul>	 F523034X

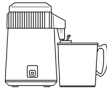
Picture	Part	Part number
	<p><b>Optional chamber rack for 2 aluminium trays and 3 wider aluminium trays for LINA 22</b></p> <p>Usable space - Cassette size (mm):</p> <ul style="list-style-type: none"> <li>■ 188 x 22 x 400</li> <li>■ 215 x 21 x 400</li> <li>■ 215 x 28 x 400</li> <li>■ 215 x 28 x 400</li> <li>■ 188 x 22 x 400</li> </ul>	 F523035X
	<p><b>Optional chamber rack for 3 cassettes /containers* for LINA 22</b></p> <p>Usable space - Cassette size (mm):</p> <ul style="list-style-type: none"> <li>■ 190 x 50 x 400</li> <li>■ 190 x 50 x 400</li> <li>■ 190 x 50 x 400</li> </ul>	 F523035X
	<p><b>Standard aluminium tray for LINA 17</b></p> <p>(186 x 19.5 x 287 mm)</p>	F523204X
	<p><b>Standard aluminium tray for LINA 22</b></p> <p>(186 x 19.5 x 379 mm)</p>	F523205X
	<b>Tray holder</b>	F523001X

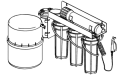

Picture	Part	Part number
	<b>Drain tube kit with fittings</b>	A812110X
	<b>Drain tube</b>	S230900X
	<b>Mains cable</b>	U38012XX
	<b>USB pen drive</b>	V000004X
	<b>Cycle report printer</b>	19721108
	<b>USB-serial adapter (for the connection of the cycle report printer)</b>	A801503X
	<b>Label printer LisaSafe (label printer only)</b>	19721109
	<b>LisaSafe Connection Kit</b> <ul style="list-style-type: none"> <li>■ USB connection cable</li> <li>■ 1 roll of 2100 labels</li> <li>■ 1 wax/resin ribbon</li> <li>■ activation code instructions</li> </ul>	19721123

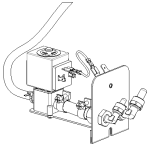
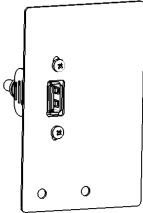
Picture	Part	Part number
	<b>QR code / Bar code reader for labels</b>	19721132
	<b>Dist - water distiller</b>	19723101
	<b>Multidem C27 - water demineralizer (only with AWF kit)</b>	19723112
	<b>Osmo - water demineralizer (osmotic principle) (only with AWF kit)</b>	19723100
	<b>Safety bracket kit</b>	X051125X
	<b>Emergency door opening tool</b>	F372106X
-	<b>Kit helix test (PCD plus 30 strips)</b>	T801003X

Picture	Part	Part number
	<b>AWF Kit</b>	X051500X
	<b>USB Kit</b>	X051405X

**Note\***: The rack, rotated 90°, accepts 5 standard aluminium trays.

## CONSUMABLES

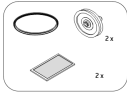
Picture	Part	Part number	When replace it
	<b>Bacteriological filter</b>	W322400X	Every 400 cycles
	<b>Door gasket</b>	F460504X	Every 800 cycles
	<b>Dust filter</b>	F364511X	Every 400 cycles
	<b>400/800 cycle consumable kit</b> Components: <ul style="list-style-type: none"> <li>■ 1 door gasket</li> <li>■ 2 bacteriological filters</li> <li>■ 2 dust filters</li> </ul>	X050328X	Refer to each single component above
	<b>250 helix strips</b>	T800205X	Before stocks are exhausted

## ACTIVATION CODES

Activation code	Description	Part number
<b>S Naked</b>	Activates the S Naked cycle	19730005
<b>Remote data storage</b>	Activates the Remote data storage	19730008
<b>Traceability</b>	Activates the <b>User Management</b> and <b>Options</b> menus	19730011
<b>All in One</b>	Activates: <ul style="list-style-type: none"> <li>■ S Naked cycle</li> <li>■ Traceability</li> <li>■ Remote data storage</li> </ul>	19730013

**Note:** use only accessories recommended by W&H.

## Authorized W&H service partners

A list and a map with your nearest W&H service partner are available at [www.wh.com](http://www.wh.com).

# Documentation forms

## CONTENTS

This section deals with the following subjects:

W&H installation check-list .....	110
Helix test documentation form .....	112

## W&H installation check-list

### QUESTIONS

N.	Question	Answer	
<b>Responsibility</b>			
1	Was the head of the clinic/practice present during all the in-service?	Yes	No
<b>Packaging and content</b>			
2	Is the packaging of the sterilizer undamaged?	Yes	No
3	When unpacked, is the sterilizer undamaged?	Yes	No
4	Are all the contents of the package available (sterilizer ship-with)?	Yes	No
5	Are all the ordered accessories available with the sterilizer?	Yes	No
6	Have you removed all the protection covers from the sterilizer and from all the ship-with?	Yes	No

N.	Question	Answer	
<b>Completeness of the Instructions for Use</b>			
7	Were all sections of the Instructions for Use of the sterilizer covered and explained during the in-service?	Yes	No
<b>Workplace suitability</b>			
8	Is the allocated countertop for the sterilizer levelled and flat?	Yes	No
9	Are the recommended ventilation indications of the allocated area for the sterilizer respected?	Yes	No
10	Are the required minimum clearances respected?	Yes	No
11	Have you explained which water quality is required for the use of the sterilizer? Check and measure the $\mu$ S of the water.	Yes	No
<b>Involvement of the Head of the clinic/practice</b>			
12	Have you shown the Head of the clinic/practice the procedure for filling and draining the main and used water tanks?	Yes	No
13	Have you shown the Head of the clinic/practice how to program the sterilizer?	Yes	No
14	Have you shown the Head of the clinic/practice the cycle options?	Yes	No
15	Have you shown the Head of the clinic/practice what the messages and alarms mean?	Yes	No
16	Have you shown the Head of the clinic/practice how to manually abort a cycle?	Yes	No

N.	Question	Answer	
		Yes	No
17	Have you shown the Head of the clinic/practice the maintenance program and procedures?	Yes	No
18	Have you shown the Head of the clinic/practice how to use all of the accessories?	Yes	No
19	Have you shown the Head of the clinic/practice the advantages of having a USB connection for a pen drive?	Yes	No
21	Have you suggested to the Head of the clinic/practice to periodically backup the data, stored on the USB pen drive and/or in a PC, on another safe support?	Yes	No
22	Have you shown the head of the clinic/practice the advantages of having a Wi-Fi connection (remote data saving)?	Yes	No
23	Have you explained to the head of the clinic/practice the correct load type for each available sterilization program?	Yes	No
24	Have you shown the head of the clinic/practice how to prepare and place the load in the sterilizer chamber?	Yes	No
25	Have you explained to the head of the clinic/practice to use only original parts and accessories on the sterilizer?	Yes	No
26	Have you shown and explained to the head of the clinic/practice the safety advise section?	Yes	No
<b>Check</b>			
27	Have you executed a Vacuum test?	Yes	No
28	Have you executed a B Universal 134 cycle program with the tray rack and trays inserted?	Yes	No
29	Are all connections to the sterilizer well positioned and plugged (accessories, etc...)?	Yes	No

## INSTALLATION INFORMATION

<b>RIK-1 Serial Number:</b>	
<b>Date:</b>	
<b>Purchased from:</b>	
<b>Installed by:</b>	
<b>Dr./Clinic name:</b>	
<b>Address:</b>	
<b>Phone:</b>	
<b>Receiver's signature:</b>	
<b>Installer's signature:</b>	

## ADDRESSES FOR SENDING THE INSTALLATION CHECK-LIST

Send a copy of the installation check-list duly filled-in to both of the following addresses:

<b>Fax:</b>	+43 6274 6236-55
<b>Mail</b>	Ignaz-Glaser-Straße 53, Postfach 1 5111 Bürmoos Austria

# Helix test documentation form

## INSTRUCTIONS

Use this page to create a logbook tracing the effectiveness of the sterilization cycle during the whole lifespan of your sterilizer.

## FORM

Date	Cycle n.	Operator	Released		Signature	Chemical indicator
			Yes	No		
			Yes	No		
			Yes	No		
			Yes	No		
			Yes	No		
			Yes	No		
			Yes	No		



Date	Cycle n.	Operator	Released		Signature	Chemical indicator
			Yes	No		
			Yes	No		
			Yes	No		
			Yes	No		
			Yes	No		
			Yes	No		
			Yes	No		
			Yes	No		
			Yes	No		
			Yes	No		
			Yes	No		
			Yes	No		
			Yes	No		
			Yes	No		
			Yes	No		

Date	Cycle n.	Operator	Released		Signature	Chemical indicator
			Yes	No		
			Yes	No		
			Yes	No		
			Yes	No		
			Yes	No		
			Yes	No		
			Yes	No		
			Yes	No		

<https://stomshop.pro/>



**Manufacturer**

 **W&H Sterilization Srl**

via Bolgara, 2  
Brusaporto (BG)

Italy

www.wh.com

+39 035 66 63 000



RIK-1

Instructions for Use

ENG

Rev03

11/05/2020

Subject to changes

