

Table of contents

What is OPTISHADE STYLEITALIANO	2	
Contents of the box	3	
Before starting	4	
App Download	4	
3 Main parts of OPTISHADE STYLEITALIANO	5	
Assembling	6	
Connecting Cable	6	
Device connection	7	
Calibration	7	
Before measuring	9	
During measuring	10	
Sweet Spot Indicator	11	
Optimal positioning	12	
Correct orientation	13	
Reading an OPTISHADE STYLEITALIANO measurement	16	
Measure screen functions	18	
After measuring	19	
What if?	19	
Light contamination	20	
OPTISHADE STYLEITALIANO goes to sleep	21	
Cleaning and disinfection	22	
How to know if a measurement is correct	24	
Do's	25	
Don't	26	
The compare functions	28	
On screen controls	30	
Accumulative errors	31	
Calibration card	32	
Reading color coordinates	34	
Color comparison simulation	36	
Perception in the dental field	37	
Interpreting color difference	38	
Trouble shooting	39	
Tips	40	
Matisse	www.stomshop.pro	41



www.stomshop.pro

What is **OPTISHADE STYLEITALIANO**

OPTISHADE STYLEITALIANO is a unique and innovative dental colorimeter. It is specifically designed for measuring the color of teeth, dental restorations, restorative materials and its appearance in the mouth.

The anatomical Capture Guide Cone helps to achieve a reliable positioning and avoids as much as possible light contamination in order to read with high repeatability the color of the tooth.

OPTISHADE STYLEITALIANO, besides giving the precise numerical color coordinates, compares the measurements with a comprehensive database of commercial shade guides.

OPTISHADE STYLEITALIANO works exclusively with an iPhone, iPad or iPod (not supplied) via an App available for free on AppStore.

Caution

It is highly important to read this booklet with attention and understand each point in it.

Your **OPTISHADE STYLEITALIANO** is an advanced technology and very delicate device that needs to be manipulated with the greatest care. Any issue resulting from a wrong or abusive or not enough careful use of your **OPTISHADE STYLEITALIANO** is not covered by the warranty (warranty : 1 year).

Contents

- 1 **OPTISHADE STYLEITALIANO** unit complete with Capture Guide Cone and Calibration Cap
- 1 lightning cable for connection **OPTISHADE STYLEITALIANO**/ iPhone-iPad
- 1 USB Charging Cable
- 4 Capture Guide Cones
- 4 Calibration Caps
- 1 Instruction for use booklet and 1 quick start guide
- **OPTISHADE STYLEITALIANO** App (free) to be downloaded on Appstore
- 30 days free licence of Matisse software



Note: If you want to connect to an iPad Pro, purchase the **OPTISHADE STYLEITALIANO** to USB-C cable. Sold separately.

- **OPTISHADE STYLEITALIANO** Cable / USB-C Art.no 70140-OS

www.stomshop.pro

Before first use

1. Fully charge the battery of your **OPTISHADE STYLEITALIANO** thanks to the supplied USB cable.

When battery is empty, a complete charge may take up to 5 hours. The battery of your **OPTISHADE STYLEITALIANO** is charged when the light at the connector turns to green.

Important: **OPTISHADE STYLEITALIANO** does not receive power from the iPhone or the iPad. Please make sure it's charged prior to each use.

When connecting or disconnecting the cable on your **OPTISHADE STYLEITALIANO**, please hold the connector and NOT the cable.

Beware insert or pull out the connector in the correct axis without twisting it or creating lateral forces or constraints.

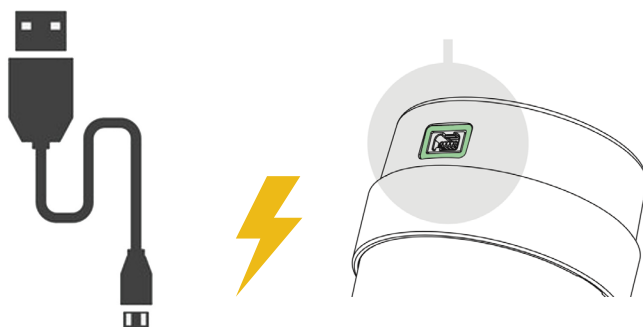

2. In the AppStore download the free **OPTISHADE STYLEITALIANO** App on your iPhone-iPad-iPod.



www.stomshop.pro

The 3 main parts of OPTISHADE STYLEITALIANO

The Calibration Cap **1** is snapped on the Capture Guide Cone **2**. Gently lift it for removing it.

WARNING! The calibration card is located inside the Calibration Cap. The calibration card is extremely fragile and sensitive. You should in no way touch it with your fingers nor risk to stain it. If you touch it with your fingers, please discard and use a new one. The Calibration Cap cannot be disinfected or sterilized. In case you are unsure about its cleanliness or in case of a risk of cross contamination, please immediately discard it and take a new one.

When the Calibration Cap is not used, save it in a bag protected from light or mount it onto the Capture Guide Cone.

The Capture Guide Cone is fixed by mean of a bayonet mount system on the base of the **OPTISHADE STYLEITALIANO 3**. For removing it from the base of the **OPTISHADE STYLEITALIANO**, keep the base in one hand and gently rotate the Capture Guide Cone a few degrees anti-clockwise with your other hand. Now the **OPTISHADE STYLEITALIANO** base separates easily. Never touch the glass with your fingers. Please check that is spotless and clean with microfiber.

WARNING! Never try to separate any of the components of the **OPTISHADE STYLEITALIANO** base. Breaking the seal cancels the manufacture's warranty.

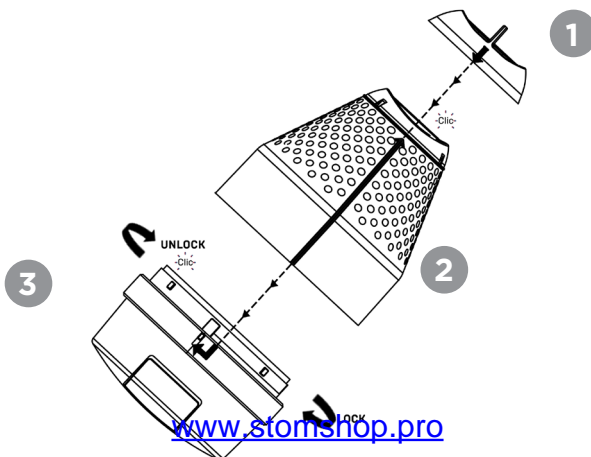

Assembling

Reassemble now the Capture Guide Cone on the **OPTISHADE STYLEITALIANO** base. Refer to the sketch on page 5.



1° Make sure to align the polished longitudinal line of the cone on the **OPTISHADE STYLEITALIANO** base and lock it by gently turning a few degrees clockwise.

2° On the Capture Guide Cone, you'll see a polished line ending with an arrow. This arrow has to be aligned to the polished longitudinal line on the Calibration Cap. Snap it on in alignment.

ATTENTION! Each component has only one possible mounting position. It is recommended to train a little bit for a good understanding of mounting principles.

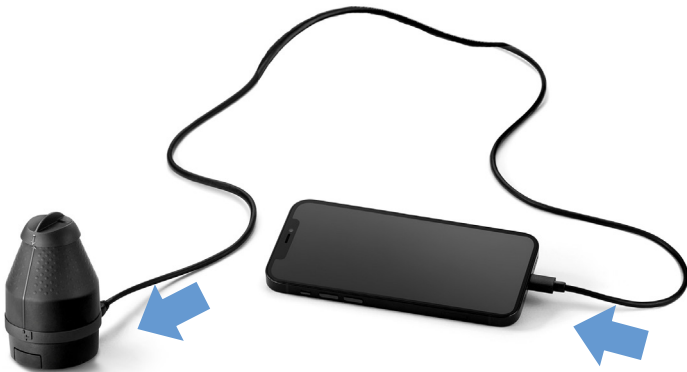

Connecting Cable

Once your **OPTISHADE STYLEITALIANO** is assembled properly, connect it to your iPhone-iPad by mean of the supplied lightning cable.

Beware insert and pull out the connector in the correct axis without twisting it or creating lateral forces or constraints.

Device connection (turning **OPTISHADE STYLEITALIANO** on)

Open the App **OPTISHADE STYLEITALIANO** (the reading is always in landscape mode). A red banner appears on the top of the screen and invites you to press the main button on your **OPTISHADE STYLEITALIANO** for 3 seconds.

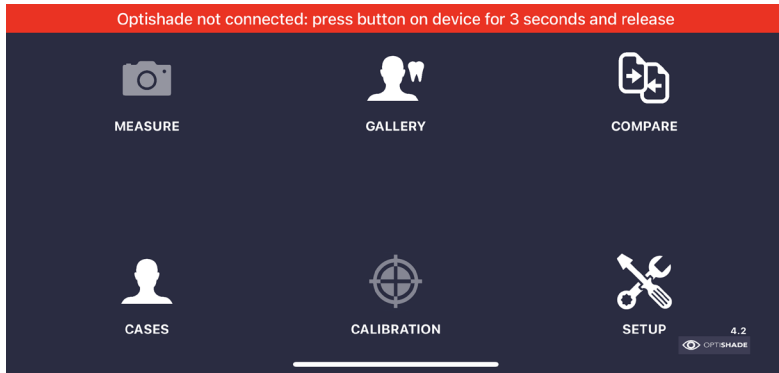

Calibration

Pop up will open and ask you to calibrate your **OPTISHADE STYLEITALIANO**. Make sure that the Calibration Cap is correctly mounted on the Capture Guide Cone and click on "calibrate".



www.stomshop.pro

If the callibration fails, check that the calibration cap is in position and that it is clean. If this occurs, it is necessary to disconnect the device and charge for few seconds.

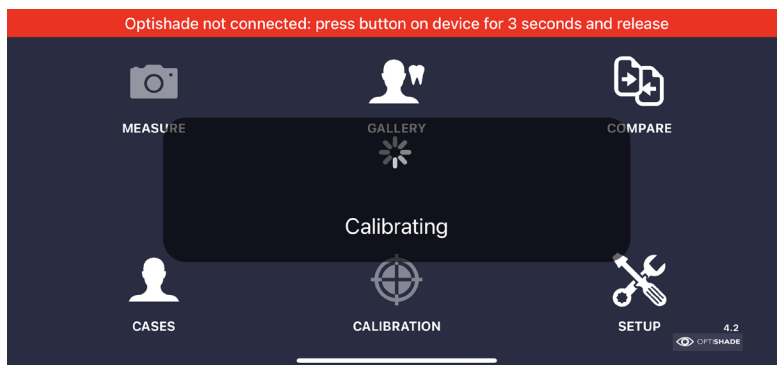

When the calibration is successful, the red banner will turn green and **OPTISHADE STYLEITALIANO** will appear connected and displaying the level of the battery.

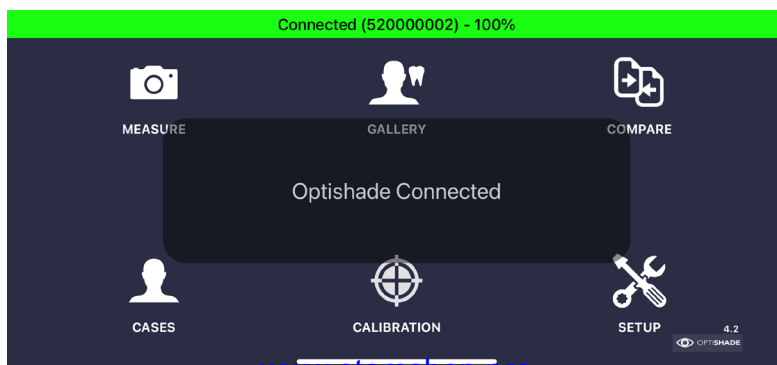

www.stomshop.pro

Capturing a tooth color with **OPTISHADE STYLEITALIANO**

BEFORE measuring:

1. Make sure **OPTISHADE STYLEITALIANO** is charged.
2. Connect and calibrate **OPTISHADE STYLEITALIANO** (page 6, 7 and 8).
3. Stay in the app's home page, don't leave the app or lock your screen.
4. Place **OPTISHADE STYLEITALIANO** and iPhone/iPad in a safe place and place the calibration card always facing down.
5. Clean the teeth that will be measured (delicate plaque/stain removal even if the tooth looks clean).
6. Patient SHOULD open the mouth ONLY when asked, to avoid teeth dehydration.
7. Reduce ambience light (close drapes/curtains, turn off unit light/ceiling light) or eliminate it completely if possible.
8. Position your device (iphone - tablet) near the subject. If unable to do so ask the patient to hold it near their face with the screen pointing towards you.
9. With one hand hold **OPTISHADE STYLEITALIANO**, with the other, mildly retract your patient's upper lip.

WARNING: consider that **OPTISHADE STYLEITALIANO** is contaminated from the moment you remove the calibration card.

Capturing a tooth color with **OPTISHADE STYLEITALIANO**

DURING measuring:

1. When on the Home Screen, click on the icon “measure”. **OPTISHADE STYLEITALIANO** lights will turn on and the video will start in the screen.
2. Ask the patient to open the mouth half way. Opening too much will make the positioning of **OPTISHADE STYLEITALIANO** difficult, opening too little will display undesired elements (as the lower teeth).
3. Ask the patient to hold their breath: **OPTISHADE STYLEITALIANO** is susceptible to fog, even if very slight, this would ruin the measurement. If there is any suspicion of fogging, stop the measurement, blow air inside the cone and start again.
4. Do a perfect positioning by orienting **OPTISHADE STYLEITALIANO**'s line perpendicular to the tooth axis. Move up-down, rotate left- right (page 12). Stabilize **OPTISHADE STYLEITALIANO**'s with the same fingers you are retracting the lip with.
5. Measure one tooth at a time: locate the target tooth in the center of the image (page 11) and shoot.
6. Right after clicking a message displaying “callibrating image”will appear. Stay still until it dissapears. The target square will appear in the middle of the screen, indicating the messurement was completed.
7. **OPTISHADE STYLEITALIANO** lights will automatically turn-off after the measurement, this will prevent your device from draining the battery.

Sweet Spot Indicator

The best area for color measurements is located in the center of the image. In this region, the colors are more stable and easier to compare.

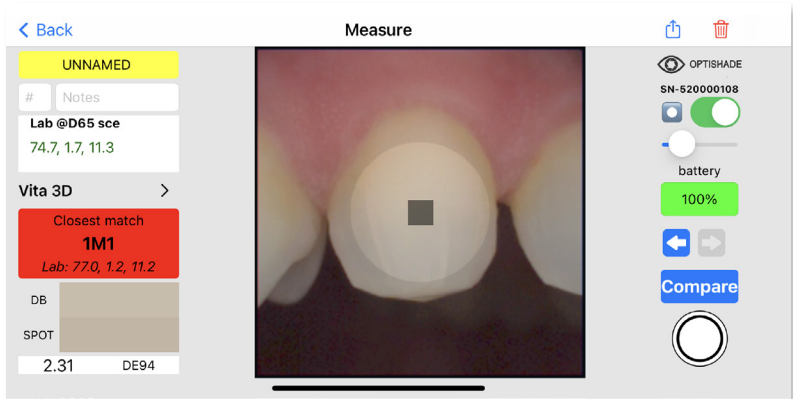

Perfect framing: Areas far from the center are less accurate and not suggested for color estimation. As the target tooth has to be perfectly centered in the image.

The Sweet Spot function can be used while measuring and while reading. In both situations is very useful. This digital simulation does not interfere with the color coordinates, it just indicates where the measurements are optimal. The digital assistant can be toggled on and off, and its intensity can be regulated (see page 29).

Optimal positioning

The perfect positioning is one of the most challenging things to learn about **OPTISHADE STYLEITALIANO**. It is highly suggested to train in a model and in the own mouth to gain experience quickly.



Correctly centered



Too mesial



Too rotated clockwise



Too rotated counter-clockwise



Too high



Too low



Too distal

www.stomshop.pro

Correct measurement: Orientation

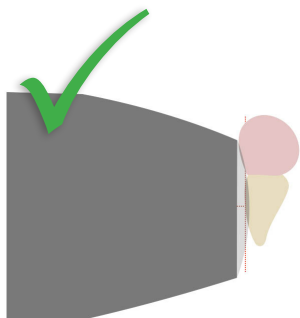

Perfectly parallel to the axis

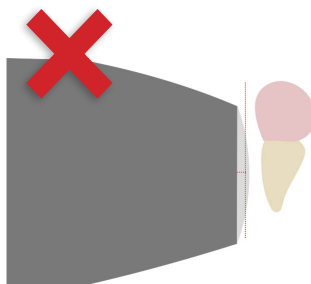

Too far

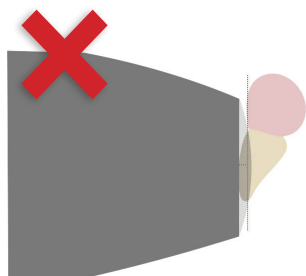

Too tilted to the front

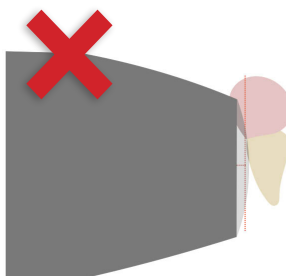

Too tilted backwards

Correct measurement: Orientation

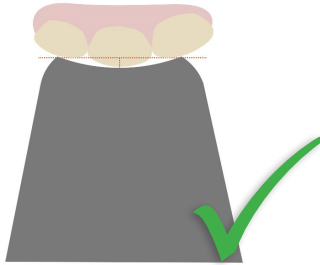

Aligned to the tooth surface by leaning on the neighbors

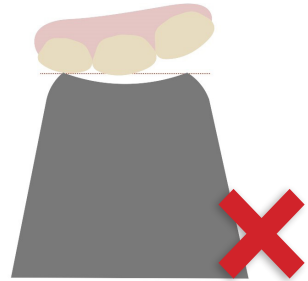

Too detached

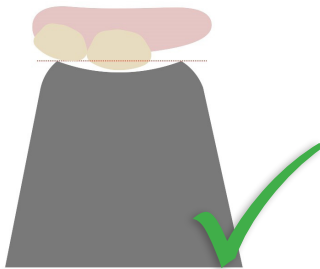

Aligned to the tooth surface even with a missing tooth

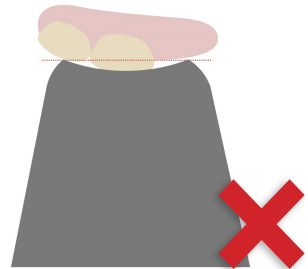

Too near

John Doe - 22/01/2021 14:00

John Doe

11 Pre Operator

Lab @D65 sce 73.3, 2.5, 16.8

Vita Classical

Closest match A2 Lab: 73.2, 3.0, 18.2

DB

SPOT 0.84 DE94

OPTISHADE SN-520000002

battery 100%

Compare

This screenshot shows the Optishade software interface. On the left, there is a sidebar with patient information: 'John Doe', '11 Pre Operator', and 'Lab @D65 sce 73.3, 2.5, 16.8'. Below this, it shows 'Vita Classical' with a 'Closest match A2' and 'Lab: 73.2, 3.0, 18.2'. There are also 'DB' and 'SPOT 0.84 DE94' fields. The main area displays a tooth image with a hand cursor pointing to a spot labeled '2'. Green arrows indicate the spot's position. On the right, there is a control panel with 'OPTISHADE SN-520000002', a battery indicator at '100%', and a 'Compare' button.

John Doe - 22/01/2021 14:00

John Doe

11 Pre Operator

Lab @D65 sce 73.3, 2.5, 16.8

Vita Classical

Closest match A2 Lab: 73.2, 3.0, 18.2

DB

SPOT 0.84 DE94

OPTISHADE SN-520000002

battery 100%

Compare

This screenshot is identical to the one above, showing the Optishade software interface. The main area displays a tooth image with a hand cursor pointing to a spot labeled '2'. Green arrows indicate the spot's position. On the right, there is a control panel with 'OPTISHADE SN-520000002', a battery indicator at '100%', and a 'Compare' button.

www.stomshop.pro

Reading an **OPTISHADE STYLEITALIANO** measurement

Immediately after shooting, the target square will appear in the center of the image. At the same time, the color correspondence will display in the “Closest Match” box. If the match with the database is green (under DE94 1.0), light squares will appear near the central measure, these squares are maximum 1.0 DE94 of the main measure.

Browsing an image:

- 1** The color measured with the target square will be graphically displayed in “SPOT” and numerically shown in the “Lab” field. Data base box will display the nearest match (i.e. A2).
- 2** The selection can be moved with the tip of the finger. It is not mandatory to position your finger over the square. If you need visibility to place the selection in a precise position, the selection can be moved with the finger located in another area of the screen.
- 3** Previous-Next button: Will display the previous or next image. If there is no previous or next image, the relative arrow will be colored gray.
- 4** Lab @D65 sce: means the Lab coordinates generated with **OPTISHADE STYLEITALIANO** are aligned with a spectrophotometer inside the dental color space with a specific illuminant and the specular component excluded.
- 5** If the displayed Lab @D65 sce numbers are not in color green, they don't belong inside the dental color space.

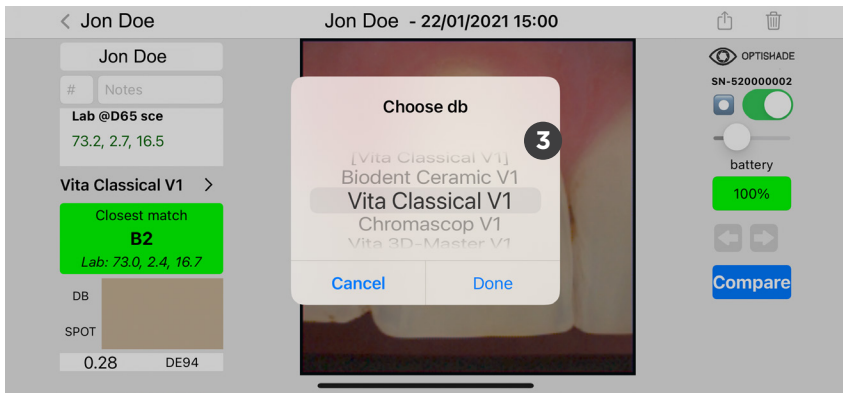
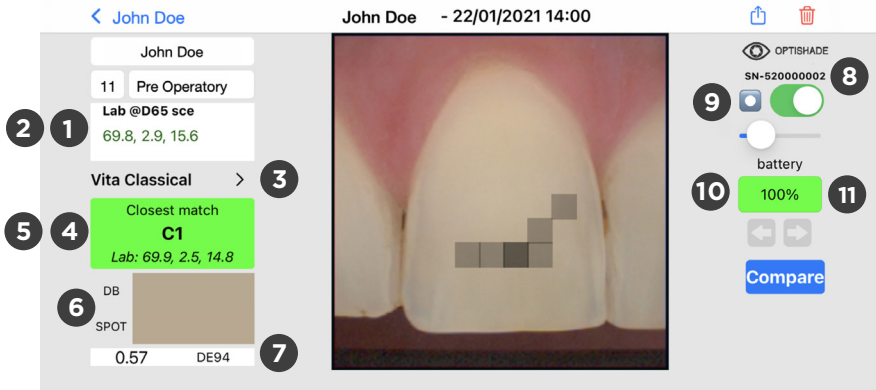

How to add more shade guides to your OPTISHADE *STYLEITALIANO*

SCAN ME for more color databases and updated shade guides in your APP!

www.stomshop.pro

Reading an OPTISHADE STYLEITALIANO measurement

- 1 Lab @D65 sce: coordinates where L* is brightness, a* is Red-Green and b* is Yellow-blue.
- 2 LCH @D65 sce: clicking in the "Lab" rectangle switches to LCH Coordinates where L* is brightness, C* is chroma and H* is hue.
- 3 Database selection: dropdown menu which will list all the color databases that **OPTISHADE STYLEITALIANO** can compare to, as Vita Classical, Vita 3D, Chromascop, etc... Select one and **OPTISHADE STYLEITALIANO** will give you the closest match according to the selected database. There are databases for intra-oral measurement and extra-oral measurement.
- 4 Closest match: compares with all the entries in the color database and gives the closest match.
- 5 Second Option: click on the "CLOSEST MATCH" rectangle and it will switch to the second nearest option found in the database.
- 6 Color simulation and comparison: shows two colored rectangles, on top "DB" which displays the color found in the Data Base and "Spot" that displays the color detected in the target square (current selection).
- 7 Color difference: expressed in DE94 (best fitting formula for color difference inside the dental color space) shows numerically how different the colors from the DB and SPOT are.
- 8 Serial: **OPTISHADE STYLEITALIANO** device serial number with which the measure was taken.
- 9 Sweet Spot: When it is activated it shows a circle inside the measurement screen. This area besides helping centering perfectly the tooth, indicates where the measurements are more precise and accurate.
- 10 Battery: level of the battery during the measurement.
- 11 Battery color: there are four possible colors for this indicator.
 1. green: Battery level is good
 2. orange: Not much charge left, but still ok for measurement
 3. red: battery level is not enough to measure, device must be recharged
 4. purple: battery level decreased significantly the device must be recalibrated. If it turns to purple while you are shooting, you can complete the current measurement as possible

www.stomshop.pro

Optimizing **OPTISHADE STYLEITALIANO** color measures

AFTER measuring:

1. Disconnect **OPTISHADE STYLEITALIANO** and place it in a safe place.
2. Remove the Capture Guide Cone and disinfect it.
3. Pass a disinfecting wipe over **OPTISHADE STYLEITALIANO** glass and backside ***WARNING:** Beware there is no moisture infiltration in your device.
4. Check that the glass is perfectly free from contamination (fingerprints, scratches, dust).
5. Position a clean cone and close it with a calibration card.
6. Charge the device.
- 7. IMPORTANT!** Recalibrate prior to new measurements when changing the Capture Guide Cone.

What if?

1. If **OPTISHADE STYLEITALIANO** prompts you to calibrate after it is contaminated, place a clean cone and calibrate again.
2. If you decide to place the Calibration Cap over the contaminated Capture Guide Cone, throw away the calibration card immediately afterwards.
3. If there is any probability of having contaminated the Calibration Cap or if its surface has been compromised (has visible contaminants or it has been accidentally touched) replace it with a new one and calibrate even if the system doesn't ask you to.
4. If **OPTISHADE STYLEITALIANO** video is not starting, the device is probably not properly connected. Reconnect and follow the screen instructions.

www.stomshop.pro

Optimizing **OPTISHADE STYLEITALIANO** color measures

Light contamination: external light is the common enemy of most color measuring systems. Although **OPTISHADE STYLEITALIANO** is designed to avoid this disadvantage as much as possible, light can filtrate through the surroundings of the cone.

OPTISHADE STYLEITALIANO measures the color in context, which means that the tooth color is measured including the gum reflection and the nearby structures.

- Avoid strong light in the environment.
- Avoid being near windows.
- Avoid strong artificial light, especially the one from the dental chair.
- When measuring models, light contamination is more likely to happen.
- Turn off the dental chair light during **OPTISHADE STYLEITALIANO** measurements, even if it's not pointing in the area you are working.

Optishad goes to sleep

After following the disinfection instructions precisely:

1. Place a clean cone.
2. Place a Calibration Cap.
3. Charge **OPTISHADE STYLEITALIANO**.
4. Put it in a safe place.



www.stomshop.pro

Cleaning and disinfection

Calibration Cap:

Don't touch in any way the calibration card (white reference). The Calibration Cap cannot be disinfected nor sterilized. In case of a doubt about its cleanliness, discard the Calibration Cap and replace it with a new one. When the Calibration Cap is not in use, store it in a bag or a box protected from light and dust. Unless you have a doubt regarding cleanliness or reliability of a Calibration Cap (in which case you must discard it), our advice is to use a new one every month.

Capture Guide Cone:

This component is supplied non-sterile and is not sterilizable. After each patient it must be cleaned with the traditional disinfection products. Make sure that the Capture Guide Cone is dry inside and outside before use.

2nd calibration:

WARNING VERY IMPORTANT! In the case that a new calibration of your **OPTISHADE STYLEITALIANO** is required for the same patient, always use a new Capture Guide Cone in order not to risk a contamination of the calibration card. If you decide to keep the same Capture Guide Cone for a second calibration, always discard the Calibration Cap at the end of the measure for not risking cross contamination with the next patient. Unless one of the previous reasons forces you to change the Capture Guide Cone before, our advice is to use a new one every month.

OPTISHADE STYLEITALIANO base:

The base of your **OPTISHADE STYLEITALIANO** must be cleaned very gently by mean of a micro-fiber tissue. You may disinfect the surface of the glass with a disinfecting wipe. It is important that the surface of the glass is always clean, dry, free of dust and stains.

Beware for not risking any infiltration of liquid inside the base of your **OPTISHADE STYLEITALIANO**. Make sure to always use a disinfection wipe that is just humid and NOT wet/damp.

VERY IMPORTANT! Any damage caused by an infiltration of liquid inside the base of your **OPTISHADE STYLEITALIANO** is not covered by the manufacturer's warranty.

www.stomshop.pro

7

John Doe

John Doe - 11/02/2021 09:47

John Doe

#11 Pre Operatory

Lab @D65 scc
74.6, 0.7, 11.8

Vita Classical >

Closest match
B1
Lab: 74.7, 0.7, 13.2

DB

SPOT

0.92 DE94

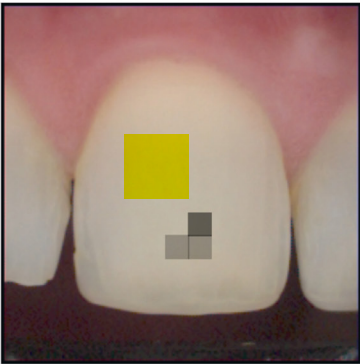

OPTISHADE
SN-52000002

battery 100%

Compare

1

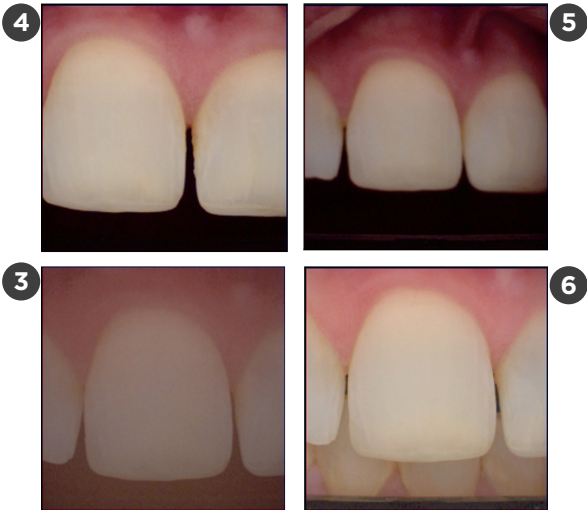

www.stomshop.pro

How to know if a measurement is correct

There are several indicators to know if your measure is correct

- 1** Power health: battery indicator should display green, otherwise there is risk of error.
- 2** Polarization: if you see reflections, make sure they don't come from external light contamination.
- 3** Position and framing: Teeth that are not perfectly centered in the image, are unlikely to have a good color measure. Areas far from the center are less precise.
- 4** Focusing: out of focus images are highly unlikely to be in the correct position for measuring.
- 5** Desaturated image: glass has fog.
- 6** Background not dark: either the tongue is too close, a foreign object near or external light is contaminating the scene.
- 7** Name, date and time is often useful to understand if something went right or wrong with your measure (as in teeth dehydration).

Do's

Keep **OPTISHADE STYLEITALIANO** charged, do not let the battery drain. Measurements are more precise and consistent with a full battery. With a full battery, the system requests to calibrate less often.

Visually analyze your calibration card, if it has debris, scratches or has been touched accidentally by external objects, replace it immediately. A contaminated card will compromise the full system.

Keep the Calibration Cap always on a clean cone.

Measure shade guides, crowns, veneers and other aesthetic restorations in a realistic model (a model that recreates the gum, the background and the neighbor teeth).

Do not

Do not measure segregated shade guides, it is extremely difficult to place them in a correct position, and you will probably get values that do not correspond with the code in your shade guide.

Do not measure gray cards, color checkers or other color references. **OPTISHADE STYLEITALIANO**'s cone is not designed for measuring flat samples and the Lab values will surely differ from the ones declared by the manufacturer of the color sample. If you need to measure flat colors for research purposes, contact us.

- jordi@styelitaliano.org

Do not judge the accuracy of the device by measuring Shade guides. Shade-guides differ among them, those values found in the DB of **OPTISHADE STYLEITALIANO** are close to the official values. It is common to find differences especially in close colors such as A2, B2, A3,5, B4 belonging to various shade guides.



www.stomshop.pro

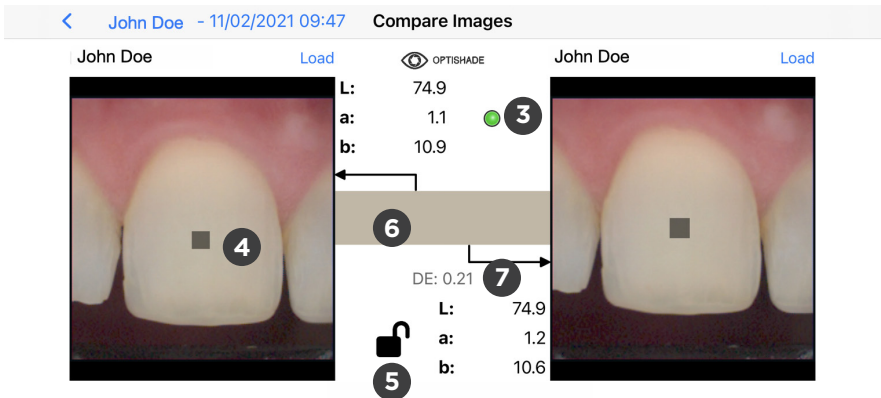
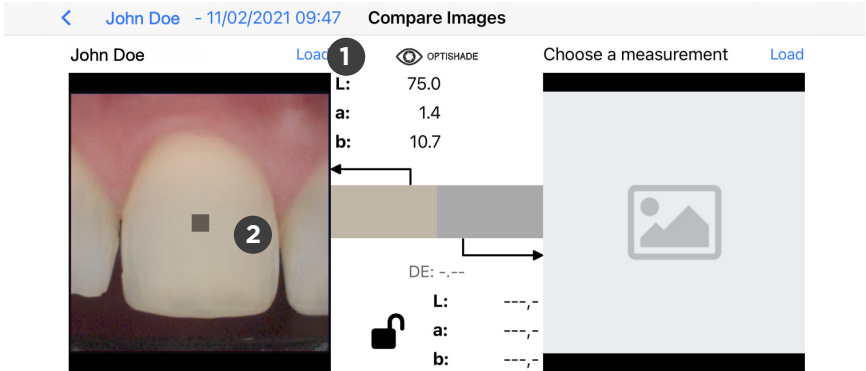

The COMPARE functions

You can access this feature from

- home screen
- any open image

- 1** Click Load to select an image from the gallery or click anywhere in the gray square with the image icon.
- 2** Once an image is open, the target square will appear in the center of the image. In order for the comparison tool to start working, it is necessary to load an image on the right.
- 3** Indicator: a colored circle will appear in the upper central part:
 - green: the two images were taken by the same device, therefore, a correct comparison can be done.
 - yellow: images were taken by two different devices, therefore, you need to consider inter device errors.
- 4** Select: you can move the measuring target square around the screen with your finger.
- 5** Lock: an open lock allows to move the selection in each image independently. A closed lock will make both squares move at the same time in the same direction. Target square can be moved on any image.
- 6** Color comparison: shows two colored rectangles, corresponding to the left and right target square. This allows the user to see a re-creation of the color difference. The division is hardly visible with small color differences (i.e. below 1.0 DE94).
- 7** Color difference: expressed in DE94 (specific formula for color difference) shows numerically the difference in the colors of the left and right target squares. It remains empty if there is only one image open.

< John Doe
John Doe - 11/02/2021 09:47
6
3

John Doe

11 Pre Operatory

Lab @D65 sce
74.6, 0.7, 11.8

Vita Classical >

Closest match
B1
Lab: 74.7, 0.7, 13.2

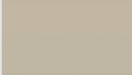
DB 

SPOT

0.92 DE94



OPTISHADE

SN-52000002

7

8 battery

100%

1 2

5 Compare

4 

OPTISHADE *STYLEITALIANO* on screen controls

- 1 Previous: arrow pointing left brings you to the previous image of the case you are currently in. The default collection is UNNAMED. If the arrow is not highlighted blue, no other image is available in that collection.
- 2 Next: arrow pointing right brings you to the next image of the case you are currently in. The default collection is UNNAMED. If the arrow is not highlighted blue, no other image is available in that collection.
- 3 Delete: immediate image elimination, an extra dialogue will appear for confirming the image elimination.
- 4 Virtual shooting button: will appear ONLY if it is possible to make a measurement. If it does not appear, go back to the home screen. Depending on the type of work, it is suggested to take more than one measurement.
- 5 Compare: sends you to the compare function described in page 27.
- 6 Share: opens a dialogue, with all the iOS capabilities to share one or more **OPTISHADE *STYLEITALIANO*** measures, among which, email, airdrop, messenger, WhatsApp, Telegram, iMessage and many more.
- 7 Sweet spot on-off (page 11)
- 8 Sweet spot intensity (page 11)

www.stomshop.pro

Accumulative errors

Color measuring requires extreme precision, several factors can result in less precise measurements.

OPTISHADE STYLEITALIANO intrinsic error: This device is able to get $L^*a^*b^*$ coordinates within the dental color space with a precision of 0,2-0,4 in the same device (intra-device). Error between different devices are of 0,3-0,5 (inter-device).

If not careful, other issues can increase measurement errors:

1. Dirty calibration card
2. Non optimal battery charge
3. Calibration, several measures have been done without recalibrating, probably the warning message has been ignored
4. Bad positioning
5. External light contamination
6. Fog

Once we control all of these factors, the error can be minimized.

Calibration card

The Calibration Cap is the support for the calibration card. It is designed to protect the white reference from light contamination and direct touch.

A simple touch with the finger, ruins the calibration card and it should be replaced.

It should be mounted on the Capture Guide Cone at all times except during measuring.

While not mounted place it on a flat surface facing down.

Keep away from direct light.

Never touch the white reference.

If dust is visible, remove it by blowing air.

Please replace the Calibration Cap often. Once every month is recommended by the manufacturer.



www.stomshop.pro

Reading color coordinates

The $L^*a^*b^*$ color space describes numerically all colors in three dimensions. L^* is for brightness and a^* and b^* for the color components green-red and blue-yellow, respectively.

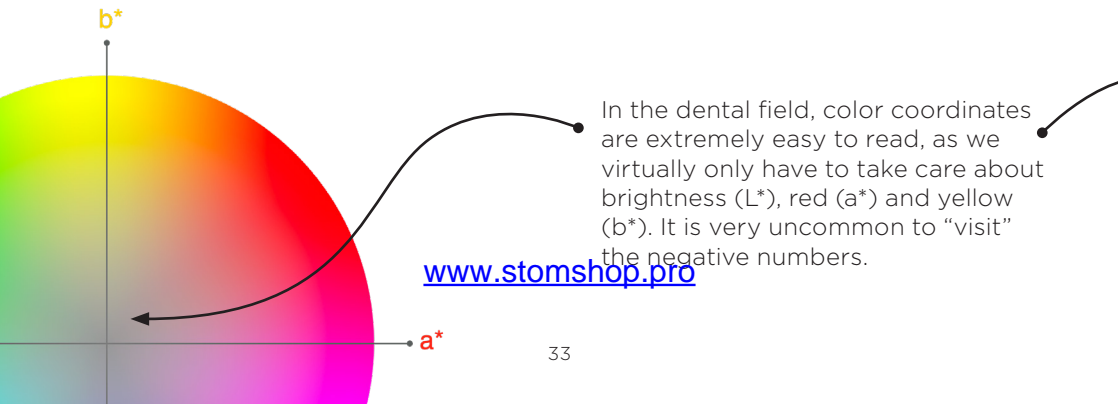
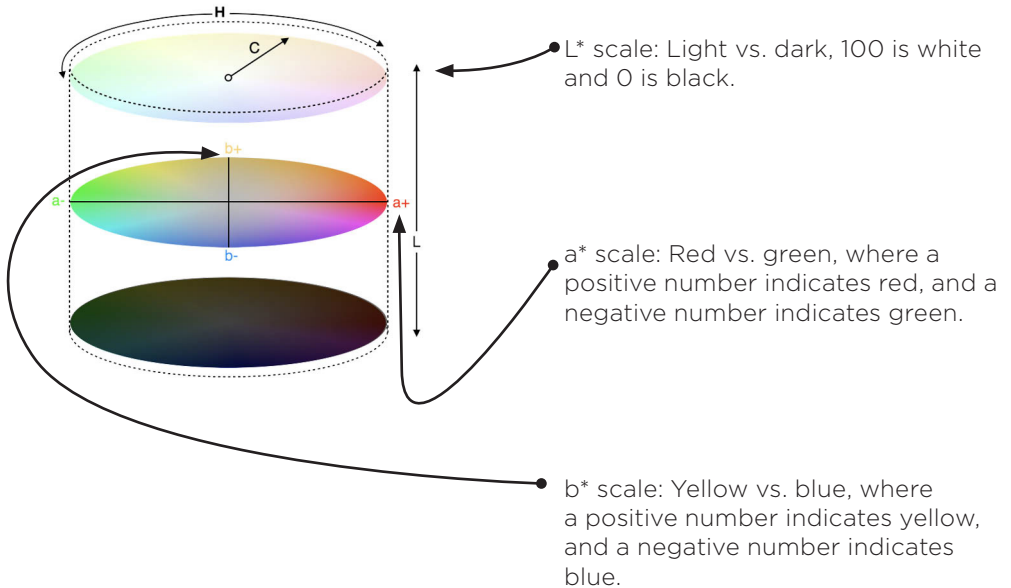

The L*a*b* scales rise above language barriers enabling anyone to easily communicate color independently of the device, and it provides the necessary information to calculate color differences.

OPTISHADE STYLETALIANO communicates in Lab coordinates and LCH, making the communication very intuitive and precise.

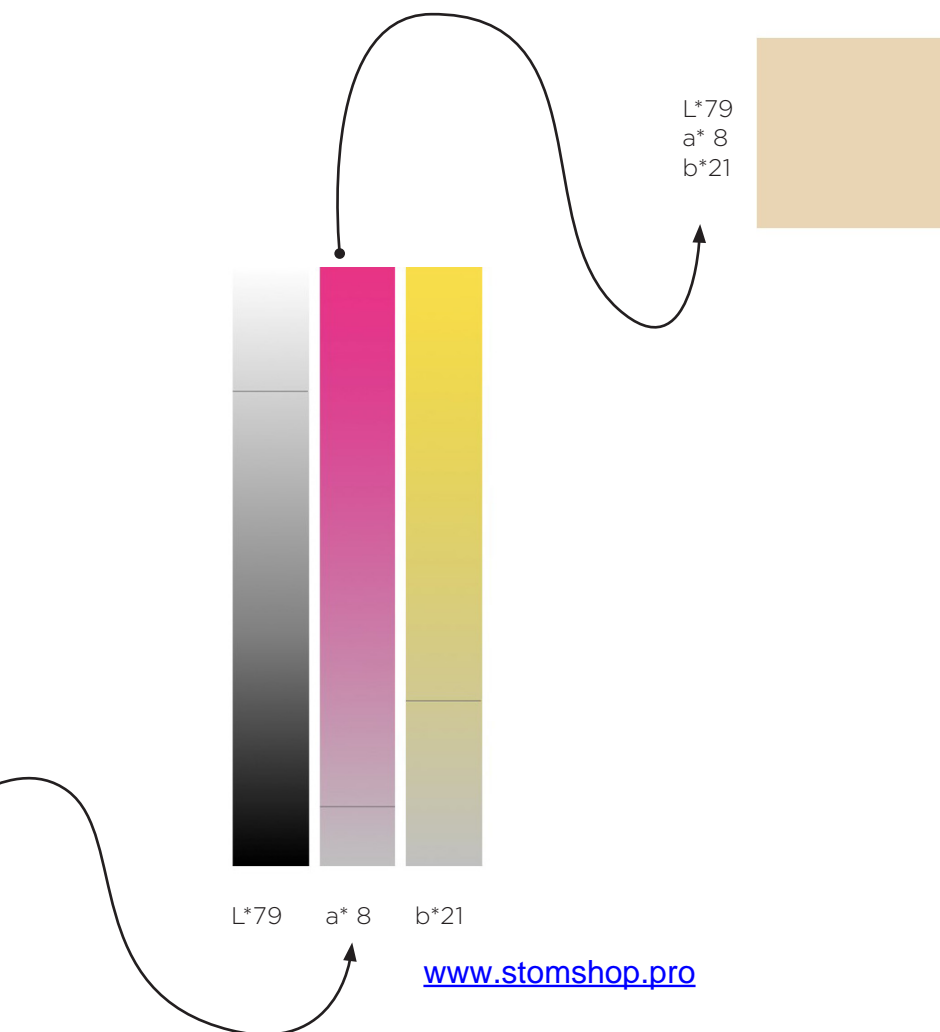



Database Reference

Spot (measurement area)



L*72.9	→	L*76.3	→	3.4% Whiter
a*-0.5	→	a* 2.9	→	More reddish
b* 13.2	→	b* 15.6	→	Slightly yellower

Lab coordinate of the shade guide loaded in the database

Lab coordinate of the measurement area

www.stomshop.pro

Color comparison simulation

- 1 Colored rectangles show a close color interpretation of the measurements.
- 2 The first rectangle (DB) shows the closest color found on the pre-loaded (shade guide) database.
- 3 The second rectangle shows the color of the actual measurement (target square).

This simulation lets you understand the difference between the Reference (DB) and the target square (Spot) and have a realistic vision of how different are the two colors being analyzed.

Color division in the simulation is horizontal, it might not be visible with small color differences (i.e. under 1.0 DE94).

This is a very powerful tool when interpreting color and understanding the differences, they might have.

ΔE_{94} PERCEPTION IN THE DENTAL FIELD

0	Identical perceived colors
<0,67	Excellent match
0,67 to 1	Very good match
1 to 1,6	Good match
1,6 to 2,7	Acceptable mismatch
2,7 to 4,7	Evident mismatch
>4,7	Unacceptable mismatch

Interpreting color difference

DELTA E is a metric for expressing how the human eye perceives color difference. DE94 or ΔE_{94} formula for graphic arts, is a color difference, that behaves in the most uniform way along all axes of the dental color space.

On a typical scale, the DE94 value will range from 0 to about 200. Zero difference is the exact same perceived color.

Our specific tolerances are shown in page 37. When measuring, **OPTISHADE STYLEITALIANO** highlights the database match with different colors. Green when an excellent match is achieved, orange is a good match, and in red all the different mismatches.

Trouble shooting

Calibration failed: it means that you calibrated without the Calibration Cap, or the card or the glass is dirty. You will need to disconnect and charge **OPTISHADE STYLEITALIANO** for a few minutes.

Video will not start: **OPTISHADE STYLEITALIANO** may have no battery, charge the device and try again.

Video will not start: **OPTISHADE STYLEITALIANO** disconnected. Go to the home screen and reconnect.

OPTISHADE STYLEITALIANO is not connecting: Charge **OPTISHADE STYLEITALIANO**, restart the app and try again. Check if the cable is not damaged or if the connection cable is loose.

Charging slot shows an orange light: there is an error in the battery. Disconnect **OPTISHADE STYLEITALIANO**, wait 5 minutes and connect again, light should turn to red. If light remains orange, please contact us.

Calibration taking too long: there was an error or light contamination during calibration. Check the calibration card, check that the glass is clean. Restart the app.

Battery 300%: it means your **OPTISHADE STYLEITALIANO** is connected with a non authorized accessory. This compromises the accuracy of your measurements.

Tips

You can take a picture by pressing the button on the back of **OPTISHADE STYLEITALIANO** or with the virtual button on the screen. Both have the same function.

Use the app with sound, there are acoustic indicators while measuring. Acoustic signals tell you if the battery is draining.

Keep a cone with a Calibration Cap already mounted and in a safe place free of light, dust and moisture. This will be handy in case **OPTISHADE STYLEITALIANO** prompts you to calibrate during a procedure.

In the app Set-up “current DB” allows to set your default shade guide.

Find video tutorials in the setup section.

Use iOS 14 or higher and keep it updated.

Update **OPTISHADE STYLEITALIANO** app when an update is available. Automatic update's function is suggested to be turned on.

Back-up your iPhone or iPad, **OPTISHADE STYLEITALIANO** information is contained in the iOS device back-up.

Use “second Option” often, it is useful to understand more about the color you are reading and the correspondence you are obtaining.



OPTISHADE

&

matisse[®]

MATISSE 30 Days Free licence

Registration process

Matisse Software offers a 30Day Free Trial. Go to www.matisse.ai, click on TRY 30 DAYS FREE and sign in with your email and a password.

During the trial period you'll receive emails with tutorials and tips on real cases. You'll also have the opportunity to book a short Zoom Call with a Matisse trainer to assist you step by step in one of your cases using Matisse Software.

www.stomshop.pro

What is Matisse

Matisse is a software for ceramic mixing and layering, it is embedded with comprehensive data and artificial intelligence technology to simplify the process of dental shade matching. The software Matisse that is compatible with **OPTISHADE STYLEITALIANO** provides complete solutions for teeth restoration: from shade taking and shade reading to generating recipes with the most commonly used ceramic brands. The recipes that Matisse provides consist only of pure ceramic powders to create restorations that mimic the histo-anatomy of the natural tooth by taking three important parameters into consideration:

- The color information of the preparation
- The color information of the target tooth
- The total amount of space available for the restoration

The end result is a restoration with no observable color differences in the patient's mouth.

”Matisse aims in minimizing remakes, while ensuring optimal results that would leave your clients and patients mesmerized”



www.stomshop.pro

How to use Matisse software with OPTISHADE *STYLEITALIANO*

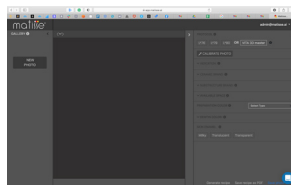
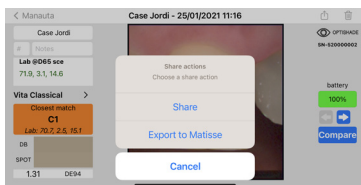

1. Send the **OPTISHADE *STYLEITALIANO*** image to your email by using: **EXPORT TO MATISSE.**

2. Go to www.matisse.ai and click on **NEW PHOTO.** Select the **OPTISHADE *STYLEITALIANO*** file.

In order to receive a customized recipe, follow the steps on the right side of the software:

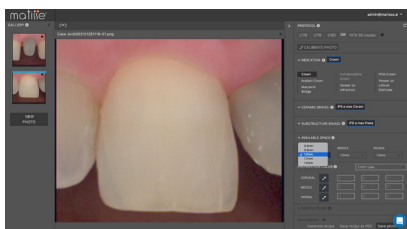

3. Select the **CASE INDICATION.**
4. Select the **CERAMIC BRAND.**
5. Select the **SUBSTRUCTURE BRAND.**
6. Fill in the **TOTAL AVAILABLE SPACE.**
7. Measure the **PREPARATION COLOR.**
8. Measure the **DENTIN COLOR.**
9. Select the **ENAMEL.**

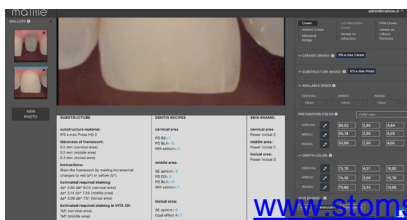

10. Click on **GENERATE RECIPE.**
*see next page for further explanation

www.stomshop.pro

Practical application of the recipe

Matisse is providing a dentine mix for the given area, this dentine mix is created according to the **OPTISHADE STYLEITALIANO** Measurement. Below is an example of the complete recipe.

	Framework	Dentin	Enamel
Brand	IPS e.max press	IPS e.max ceram	IPS e.max ceram
Recipe	HO0 0.3mm	PD B2 x 1 PD BL4 x 15 MM Salmon x 4	Power incisal 2

* Smile Line ceramic portioners are suggested to prepare the dentine recipes

Proceeding with the case **OPTISHADE STYLEITALIANO** is used in each step to evaluate the color with the compare mode.

< Case Jordi - 25/01/2021 11:16 Compare Images

Case Jordi Load OPTISHADE Case Jordi Load

L: 75.1
a: 4.1
b: 16.7

DE: 1.00

L: 74.6
a: 5.0
b: 15.9

www.stomshop.pro