



Microline

Extremely lightweight and exceptional clarity.

Panoramic

Highest-rated flip-ups with a wider field of view.



Legacy

Greatest-value flip-up on the market.

For any questions or problems, please contact your local distributor or call DenMat Customer Care at 1-800-433-6628 between the hours of 8am to 5pm (Pacific Time) Monday-Friday. Outside the U.S., please call 1-805-347-7990.



 Den-Mat Holdings, LLC
1017 W. Central Avenue
Lompoc, CA 93436 USA
denmat.com

EC	REP	MDSS GmbH Schiffgraben 41 30175 Hannover, Germany
----	-----	---



Flip-up Loupe and Frame Directions for Use

Instructions, warranty and cleaning for
PeriOptix Flip-up loupe system and frame

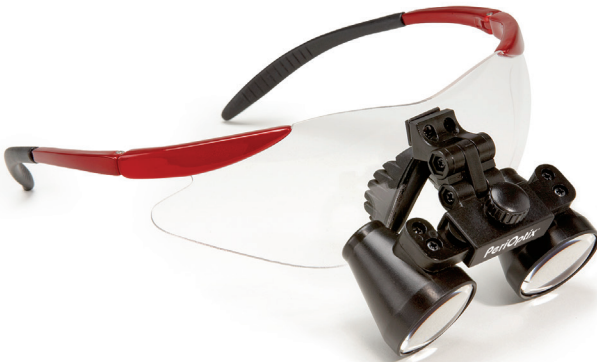

Please note that your loupe system arrives complete and requires no assembly!

Contents

Inspect contents. If any item is missing, contact DenMat Customer Support.

1. Loupe Optics
2. Frame
3. Case
4. Lens Covers (Legacy Optics only)
5. Microfiber Cleaning Cloth
6. Anti-Fog Cleaner
7. Glasses Strap
8. Phillips Screwdriver (Legacy) or Hex Screwdriver (Panoramic)

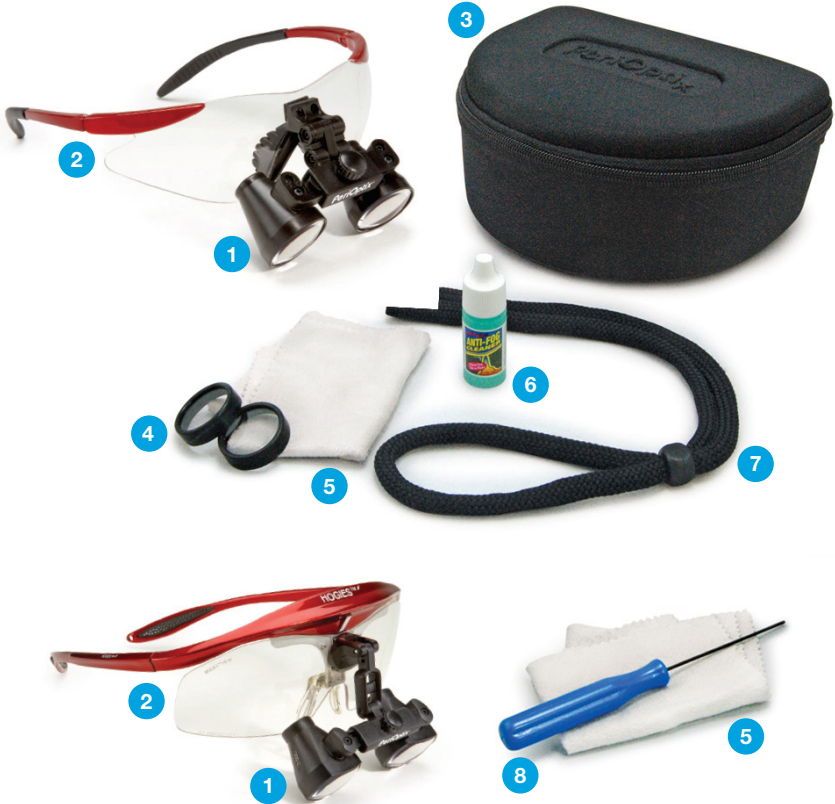

Warranty

DenMat warrants its products to be free of original defects in material and workmanship and to perform in accordance with specifications for the following terms:

Limited Lifetime Warranty

All Loupe optics, Solaris and Mini headlight element. All working parts of the loupe hinge mechanism.

One-Year Limited Warranty

All Loupe frames except Rimz and Mirage. All components of Solaris and Mini headlight system.

Six-Month Limited Warranty

Rimz and Mirage frames.

Warranty Exclusions:

- Breakage or failure due to tampering, misuse, neglect, accidents, modification or shipping.
- If the instrument is not used in accordance with manufacturer's recommendations or instructions.
- If repaired or serviced by other than DenMat or a DenMat authorized representative.

Prompt inspection and reporting of missing or damaged product should be reported to shipping carrier and DenMat within 3 days of receipt of product.

If DenMat products or any component thereof is found to be defective or at variance with the manufacturer's specifications during the warranty period, DenMat will repair or replace the instrument or component(s) at no cost to the purchaser. This warranty only applies to products purchased new from DenMat or its authorized distributors or representatives.

5. Securing Declination Angle

Securing the declination angle will allow you to flip-up your loupe optics so that they pivot only on the upper joint.

- 5.1 To do so, securely tighten the lower hinge joint with a Phillips screwdriver. Increase or decrease the tension by tightening or loosening the upper screw.
- 5.2 Declination angle will be secured when optics are flipped up

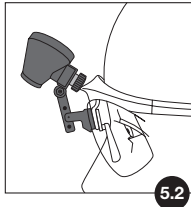
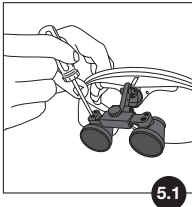

6. Cleaning and Disinfecting Lenses and Shields

Use the supplied cloth to clean the optical lenses and shields. A lightly moistened cloth with alcohol or eyeglass lens cleaner can also be used. **DO NOT WET OR IMMERSE THE OPTICAL LENSES IN WATER OR LIQUID.** For all other components such as the frames, nose pad and hinges, clean with an alcohol or disinfectant wipe. It is recommended that lens covers are used on the front of the loupes. These can be removed, cleaned thoroughly, dried and replaced on the loupes.



- DO NOT SUBMERGE PRODUCT OR SUBJECT TO SURFACE SATURATION WITH ANY LIQUID OR ULTRASONIC CLEANER. Your product is not waterproof.
- DO NOT CLEAN VIA AUTOCLAVE, CHEMICLAVE, GLUTARALDEHYDE, IODOPHOR, OR ANY OTHER STERILIZATION METHOD.
- NO MODIFICATION OF THIS EQUIPMENT IS ALLOWED

7. Storage

When not using your loupes, store in the supplied carrying case with the lens covers in place (Legacy optics only). Avoid moisture and store in a dry environment.

Loupe Terminology

A. Declination Angle

B. Convergence Angle

C. Interpupillary Distance (IPD) — distance between the pupils

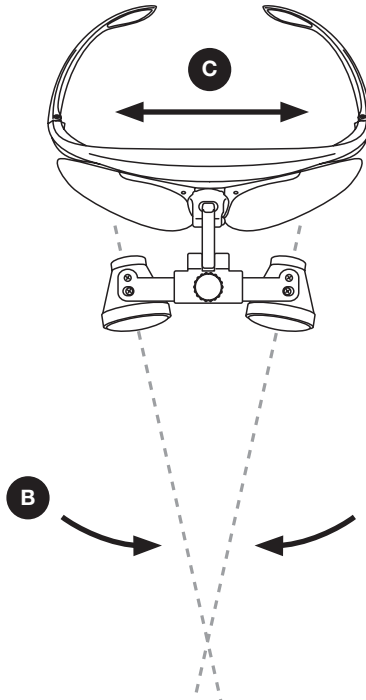
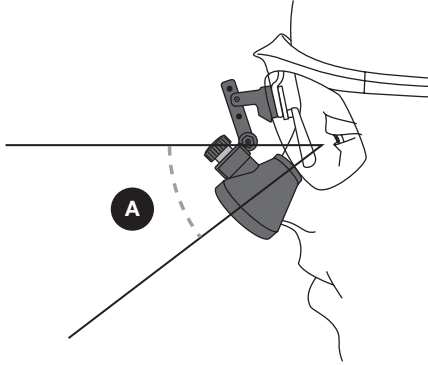

Indications

The loupe system may be used to magnify a specific working field. Loupe optics are designed for multiple use and are non-sterile.

Precautions

The loupe optics should be worn as close as possible to your eyes to achieve the greatest field of view and declination angle. When adjusting, the loupe barrels should be against or close to the eye shield with the loupes between pointing at a steep downward angle.

Incorrect loupe position decreases field of view and declination angle.



Correct loupe position

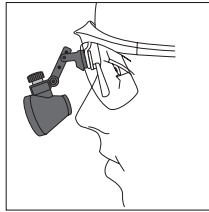

Incorrect loupe position

Step-By-Step Directions

1. Focusing

- 1.1 Loupe optics have a preset focal distance. An easy way to determine the working distance of the loupe optics is to view your thumbs while moving them in and out of focus.

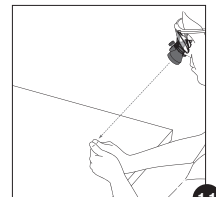

Determine focal distance **1.1**

2. Adjusting IPD (Interpupillary Distance)

- 2.1 With the Optilock® feature, the only adjustment that is usually needed is to set the IPD (Interpupillary Distance). While focusing on an object, pull up on the Interpupillary Adjustment Knob and rotate, moving the optics apart and together. Look at the outside rings of the field of view when adjusting the IPD.
- 2.2 Focus on an object with the optics far apart.
- 2.3 Bring the optics together until a single circle is observed. When a single circle is observed the IPD is set.

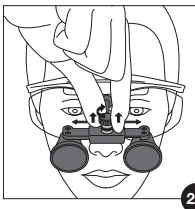

2.1

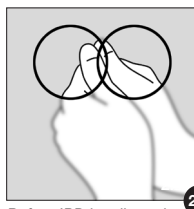

Before IPD is adjusted **2.2**

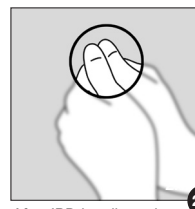

After IPD is adjusted **2.3**

3. Convergence Angle Test

The convergence angle of the loupe optics is preset at the factory to the working distance. Normally no adjustment is required.

- 3.1 To test the convergence angle, draw a single dot on a piece of paper. Focus on the dot with the loupe optics at the proper working distance. The convergence settings should not require adjustment unless two dots are seen.
- 3.2 Two horizontal dots indicate horizontal misalignment. Proceed to step 4 to correct the convergence angle.
- 3.3 In the rare case that two vertical dots indicate a vertical misalignment, the loupes should be returned to PeriOptix for adjustment.

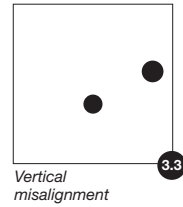
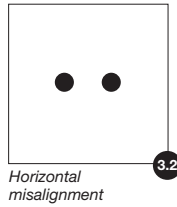
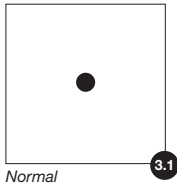

4. Adjusting Convergence Angle

Before adjusting the convergence angle, set the IPD (see step 2). Then, follow the instructions in step 3. There is a convergence error if two horizontal dots are seen. Rotate the lens barrels to eliminate the horizontal convergence error.

- 4.1 To adjust the horizontal convergence angle, first look downward at the loupe optics from the top to see if the barrels are equally angled.
- 4.2 Barrels out of alignment will appear asymmetrical.
- 4.3 For Legacy optics, if a barrel seems out of alignment, loosen both convergence adjustment screws with a phillips screwdriver. For Panoramic optics, use the provided hex screwdriver.
- 4.4 Adjust one or both barrels so they are pointing slightly and equally inward.
- 4.5 Slightly tighten both screws to keep them in alignment. Focus on the dot from Step 3. If two dots are still seen, repeat steps 4.1 through 4.5 until one dot is seen and both barrels are pointing inward equally. Once set, tighten both convergence screws on each barrel.

