

# Polishing Compact Unit **WP-Ex 10 II**



**USER MANUAL**

**Dear customer,**

Thank you for choosing a product from the Wassermann range. Wassermann Dental-Maschinen incorporates the highest standards of quality and the latest technology. In order to enjoy maximum performance and years of trouble-free operation, please read this user manual carefully before you connect this device and start work, and operate the device according to the recommended guidelines. The operation safety and the functionality of this device can only be guaranteed if you follow both the general safety guidelines and the applying laws to prevent accidents as well as the precautions given in this user manual. We are not liable for any damages which occur due to inappropriate usage or faulty operation of this device.



Make sure that anyone using this device has read and understood this user manual.

Keep this user manual in a safe place where it can be referred to as required at any time.



The unit complies with the relevant EU guidelines.



The unit is subject to the EU guidelines 2012/19/EU (WEEE Directive).

**Company address:**

Wassermann Dental-Maschinen GmbH

Rudorffweg 15-17

21031 Hamburg, Germany

Phone : +49 (0)40 730 926 -20/ -24 Fax.: +49 (0)40 730 37 24

export@wassermann-dental.com

www.wassermann.hamburg

www.facebook.com/WassermannDentalmaschinen

## Contents

1 Features.....	4
2 Safety Symbols used in this Manual.....	4
3 Safety Guidelines.....	5
4 Responsibility for Operation or Damage.....	6
4.1 Warranty.....	6
5 Application.....	7
6 Before Starting.....	7
6.1 Transport.....	7
6.2 Installation.....	8
6.3 Storage.....	8
7 Installation/ Start-up.....	9
7.1 Installing and Removing the Brush Spindles.....	9
8 Operation.....	9
8.1 General Operating Instructions.....	9
8.2 Handling of the Unit.....	10
9 Troubleshooting.....	11
10 Care and Maintenance.....	12
10.1 Cleaning.....	12
10.2 Maintenance.....	13
10.2.1 Filter and Changing the Filter.....	13
10.2.2 Changing the Integrated LEDs.....	14
10.2.3 Changing the Fuse.....	15
The fuse of the WP-Ex 10 II is located next to the socket of the supply line plug.....	15
10.3 Repairs.....	15
10.4 Spare Parts.....	15
10.5 Service Hotline 0049 (0)40 730 926 -20/ -24.....	15
10.6 Scope of Delivery/ Accessories.....	16
11 Technical Data.....	16
12 Disposing of the Unit.....	17
12.1 Information on Disposal for Countries within the EU.....	17
13 EU Declaration of Conformity.....	18

## 1 Features

- Compact and powerful polisher for daily use in the laboratory in the smallest space
- Shaft end has 9 mm standard taper for mounting the brush spindle (right)
- Powerful, long-life and maintenance-free squirrel-cage motor
- 2 switching steps, 1,500 resp. 3,000 min<sup>-1</sup>
- Micro-fine dust filter bag, large capacity and easy to replace
- Jacket-cooled motor, dust protected
- Impact-resistant, adjustable safety glass viewing protection
- Integrated daylight LEDs
- Daylight LED spot available as special accessory
- High quality workmanship, most parts made of stainless steel
- Easily removable full rubber polishing trough
- Low-noise, with extraction suitable for continuous use
- Numerous storage options
- Emergency off-switch and restart protection guarantee safety at work

## 2 Safety Symbols used in this Manual



### **Warning!**

This is a warning of risk situations and dangers.

Failure to observe this warning could be life-threatening. These warnings has to be observed.



### **Information!**

This symbol draws your attention to specific features that has to be observed.

### 3 Safety Guidelines

Configuring and operating this equipment requires **precise knowledge** and **observance** of the instructions in this **user manual**. The equipment is designed only for its intended application.



**WARNING:**

Servicing and repairs should be carried out only by authorised specialists.  
Disconnect the power plug before starting any maintenance work.



Make sure that the equipment is connected to the correct power source.



- The retaining brackets (white) have to be above the filter frame so that the filter bag is fixed in place, and the cover must be closed.
- The **main switch** also functions as **safety switch**. If the power supply is interrupted, **the switch will go into centre position** in order to prevent an uncontrolled operation of the motor when the power supply is restored.  
**Reset** is effected in two steps:  
Step 1: Switch rocker into OFF position.  
Step 2: Reset circuit breaker. Main switch into ON position.
- The fuse of the **WP-Ex 10 II** is located next to the socket of the supply line plug.

## 4 Responsibility for Operation or Damage

The responsibility for operating the device lies exclusively with the owner or user if said device is incorrectly serviced, maintained or altered by persons not employed by an authorised dealer or if the device is used in a manner contrary to its specified purpose. The unit has to be maintained and operated in accordance with this user manual. Wassermann Dental-Maschinen GmbH is not responsible for damage arising from the **nonobservance** of these instructions.

Warranty and responsibility provisions contained in the sales and supply conditions of Wassermann Dental-Maschinen GmbH are not extended by these instructions.

### 4.1 Warranty



The warranty period for our equipment is 12 months. If faults occur within the warranty period, contact your dental depot or get in touch directly with our service department.

Your equipment should only be operated in perfect condition. If faults occur which could harm operators or third parties, the unit should not be used until it has been fixed.

This warranty does not cover damage caused by improper use, external mechanical causes, transport damage or interference with the unit by unauthorized persons.

## 5 Application

The polishing unit serves for the polishing of dentistry work. Thanks to the integrated suction feature, optimal operation is guaranteed.

Only use the device for this type of application.

## 6 Before Starting

### 6.1 Transport

Before transporting the unit, ensure that it has been unplugged from the power socket. Make sure that it is packed correctly in order to avoid accidental damage.



Be sure to check for any transport damage when unpacking the goods. Note down any damage if found.

## 6.2 Installation

Open the box, remove the packing materials, and carefully lift out the device and accessories. Check the included accessories.



For transport ex works the polishing motor is supported by a stable paperboard block. Please remove this transit support before using the unit.



The device has to stand horizontally on a steady and even surface. Install the device in a place where it will not block the working area and the functionality (take the dimensions into account). Make sure that there are about 10 cm of free space on each side to guarantee air circulation (heat dissipation).



Do not install the unit outdoors or in places without proper ventilation. Before start-up, be sure the device reaches room temperature.

## 6.3 Storage

The unit location is very important when it comes to workplace safety, even if it is only to be set up there for a short period. The room should be dry, well ventilated and vibration-free. An even temperature and wooden supports also help. The unit should not be stored or set up outdoors. If the unit is to be stored for an extended period, protect it from moisture and dust.



## 7 Installation/ Start-up



**Before** starting the unit:

### 7.1 Installing and Removing the Brush Spindles

Use compressed air to blow away dust and dirt from the brush spindle.

Remove the disassembly nut by turning it clockwise (left hand thread). Remove grease from the shaft extension and re-mount the disassembly nut by turning it counter-clockwise. When doing so make sure the disassembly nut is fully tightened.

Installing the brush spindle:

Install the brush spindle according to its labelling, R=right.

Use a hammer and a piece of plastic to tap the spindle lightly and carefully onto the end of the taper.

**There is a risk of damage to the ball bearing caused by external forces. This terminates the warranty.**

**Finally**, insert the power plug into the socket, making sure that the mains and the unit operate on the same voltage.

When the motor is operating, the spindle must to turn centrically. If this is not the case, please repeat the process.

## 8 Operation

### 8.1 General Operating Instructions

All instructions for using the unit, whether in verbal or written form, are based on our own experience and experimentation and can only be regarded as guidelines.

## 8.2 Handling of the Unit

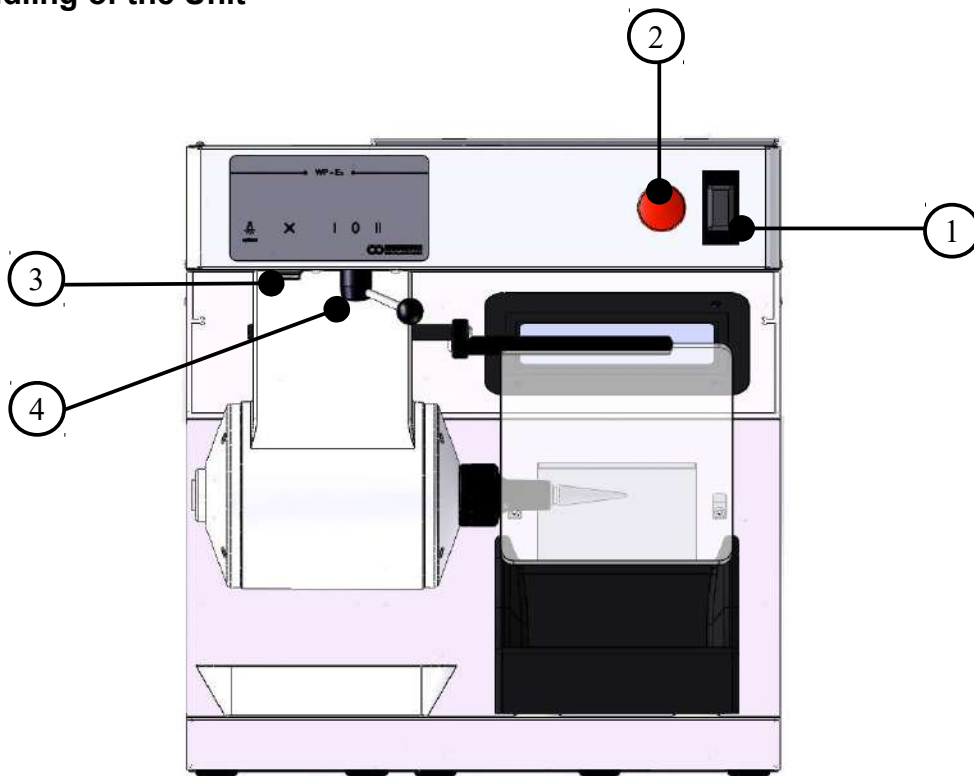

- ① Main / Protection switch: The device is powered. The lighting is on.
- ② Emergency off: After pushing the emergency off [2] and a check of all facts, the unit can be restarted by switching on the main switch [1].  
\* **Reset** is effected in two steps:  
Switch rocker [1] into OFF position.  
Reset circuit breaker. Main switch [1] into ON position.
- ③ Rocker switch: On / Off switch suction
- ④ Toggle switch: Position I = Speed 1500 min<sup>-1</sup>  
Position 0 = Motor turn off  
Position II = Speed 3000 min<sup>-1</sup>

- The **WP-Ex 10 II** is powered by switching on the main switch [1].



The **main switch** also functions as **safety switch**. If the power supply is interrupted, **the switch will go into centre position** in order to prevent an uncontrolled operation of the motor when the power supply is restored.

**Reset** is effected in two steps:

Step 1: Switch rocker [1] into OFF position.

Step 2: Reset circuit breaker. Main switch [1] into ON position.

- The suction can be turned on or off manually with the rocker switch [3].
- With the toggle switch [4] two speed settings can be chosen.

## 9 Troubleshooting

Fault	Cause	Solution
Spindle does not hold	Spindle loose	Set the spindle in place by lightly tapping with a hammer
Spindle cannot be loosened	Spindle is too firmly attached to the cone	Contact our service department
No or very little suction capacity	Filter bag full	Replace filter bag
Ball bearing noise	Ball bearing defective	Contact our service department
Light does not work	LEDs defective	Replace the LEDs
Device does not work	Rocker actuator [1] into centre position	Switch rocker [1] into OFF position. Reset circuit breaker. Main switch [1] into ON position.
	Fuse defective	Check the fuse. Disconnect the power plug before starting any maintenance work. Change the fuse if necessary: REF 582013 FUSE 6.3 A M



If the above recommendations do not solve the problem, contact your dental depot or our service department.

## 10 Care and Maintenance

### 10.1 Cleaning



Disconnect the power plug before starting any maintenance work.

The identification plate has always to be kept in easily legible condition and has not to be removed.



Remove external dirt from time to time with some form of cold cleaner.

Use only cold cleaners to avoid damaging the paintwork or removing the lettering. The equipment should be cleaned at regular intervals to ensure trouble-free operation.

It requires only normal cleaning (sponge, damp cloth, mild detergent) and no further chemical additives.



Make sure the disassembly nut for the brush spindle remains clean within the hole. Pay particular attention when polishing with pumice.



When unscrewing the disassembly nut, pay attention to the fact that **the right side has a left-hand thread**.

## 10.2 Maintenance

The unit does not require any servicing. Just make sure that the device is kept clean and a matched filter change should take place according to the needs.

-  The unit is equipped with a extra large micro fine dust filterbag.  
If the suction power decreases, please change the filter!

### 10.2.1 Filter and Changing the Filter

Open the two clamps on the rear panel. Then the cover can be slided back and be removed. Turn the retaining brackets (white) above the filter frame sideways, so that the filter bag can be changed. Insert new filter bag, making sure that the filter bag is smoothly inserted into the unit. Afterwards the retaining brackets (white) have to be turned back above the filter frame so that the filter bag is fixed in place. Replace the cover, slide forward and secure with two clamps.

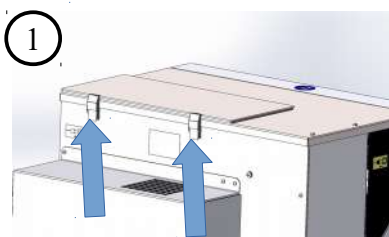

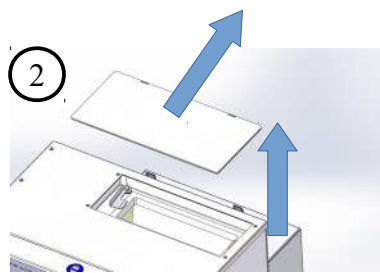

(Backview)

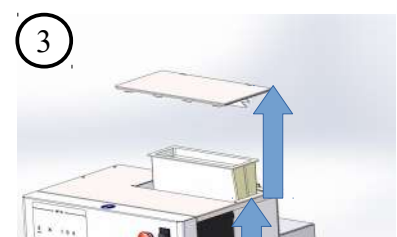

(Frontview)



(Frontview)

-  Loose the clamps
-  Lift the lid in the back slightly and push it backwards
-  Remove the cover and change the filter.

### 10.2.2 Changing the Integrated LEDs

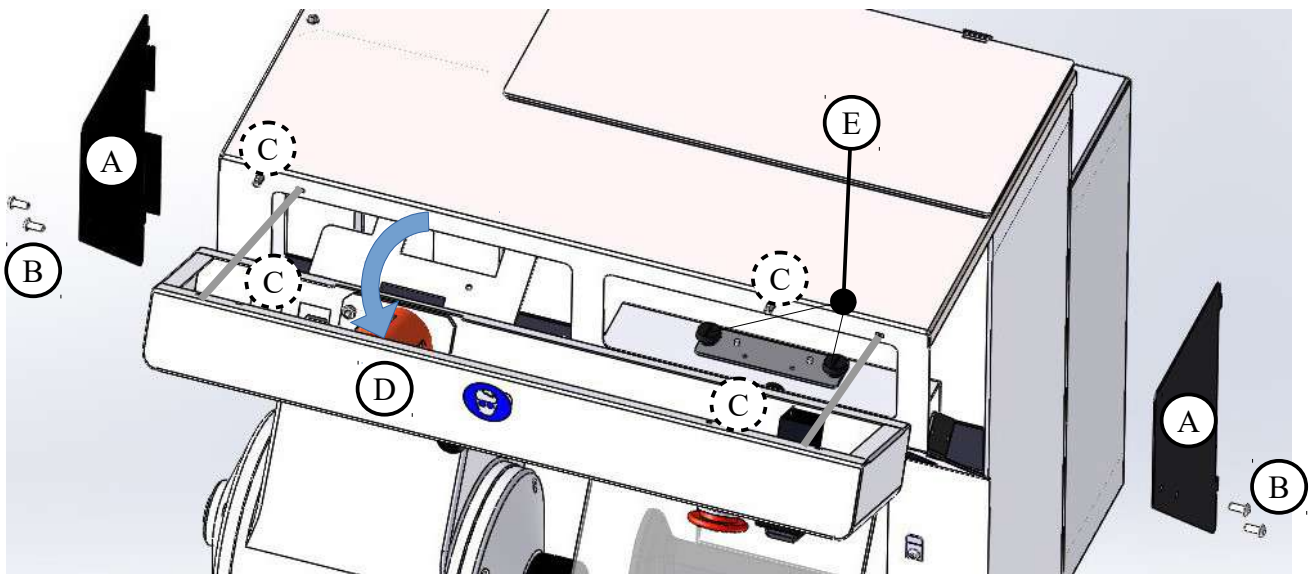

**Disconnect the power plug before starting any maintenance work.**



- To open the service covers [A] on the right and left side of the unit unscrew the four screws [B] by using an Allen wrench.
- Then loose the four knurled screws [C] of the cover [D] inside the unit .
- The cover has not to be removed completely. It can be carefully hinged down and placed on the engine.
- Resolve the plug connection of the LED power cable.
- Dissolve now the two knurled screws [E] and remove the defective LED strip from the white retaining plate.
- Then insert the plug of the new LED bar in the plug connector and tighten the new LED strip with the knurled screws [E].
- Now fold up the cover [D] and tighten the four knurled screws [C] inside the unit hand-screwed.
- Insert service covers [A] right and left and fix each with the two screws [B].

### **10.2.3 Changing the Fuse**

The fuse of the **WP-Ex 10 II** is located next to the socket of the supply line plug.  
Remove the damaged fuse and insert a new one.

### **10.3 Repairs**



Servicing or repairs to the unit has only to be carried out by qualified technicians.  
Only original spare parts are to be used. Responsibility for the product is voided  
if unauthorised persons alter it or if inappropriate components are installed.

### **10.4 Spare Parts**

If necessary please contact our service hotline phone.

### **10.5 Service Hotline 0049 (0)40 730 926 -20/ -24**

## 10.6 Scope of Delivery/ Accessories

Included parts	Item no.
Brush spindle right	152022
Polishing trough	146503
Supply line	592012
Storage bowl (W 257 x H 40 x D 198 mm)	830409
Micro fine dust filterbag	- - -

Accessories/ Spare parts	Item no.
Brush spindle right	152022
Brush spindle 125 mm right	152043
Stone holder right	152056
Drill chuck right 1-6 mm clamping	152049
Storage bowl (W 257 x H 40 x D 198 mm)	830409
Micro fine dust filterbag, 1 set =2 pieces	611005
Suction protective grid, 1 piece	146396
Daylight LED spot	146390
Fuse 6.3 A M	582013

## 11 Technical Data

<b>WP-Ex 10 II</b>	<b>Item no.: 146971</b>
Voltage	220–240 V / 50/60 Hz
Power consumption	2.2 A
Output	500 W
Fan capacity	445 m <sup>3</sup> / h (free-blowing)
W x H x D	455 x 485 x 505 mm
Weight	37 kg
Sound level	≤ 65 dB (A)
Speed	1500 / 3000 min <sup>-1</sup>

Other voltages on request.

The noise level of the unit amounts to ≤ 65 dB (A).

 Technical changes reserved.



## 12 Disposing of the Unit

The unit has to be disposed by an authorized recycling operation. The selected company has to be informed of all possibly health-hazardous residues in the unit.

### 12.1 Information on Disposal for Countries within the EU



To conserve and protect the environment, prevent environmental pollution and improve the recycling of raw materials, the European Commission adopted a directive that requires the manufacturer to accept the return of electrical and electronic units for proper disposal or recycling.

Within the European Union units with this symbol should not therefore be disposed of in unsorted domestic waste.

For more information regarding proper disposal please apply at your local authorities.

**13 EU Declaration of Conformity**

in accordance with 2014/35/EU (Low Voltage Directive) and 2014/30/EU (Electromagnetic Compatibility Directive) and 2006/42/EC (Machinery Directive) and 2011/65/EU (RoHS Directive)

Manufacturer: **W A S S E R M A N N** Product description: Polishing  
Dental-Maschinen GmbH Compact Unit for  
Rudorffweg 15-17 dental  
21031 Hamburg applications  
Germany

Model: WP-Ex 10 II Item no. 146971

Applicable standards: DIN EN 61010-1  
DIN EN 61000-6-3  
DIN EN 61000-6-1  
DIN 45635-1  
DIN EN 60335-1

Hiermit wird bestätigt, dass die oben bezeichnete Maschine den genannten EU-Richtlinien entspricht. Diese Erklärung wird ungültig, falls die Maschine ohne unsere Zustimmung verändert wird.

This is to confirm that the above mentioned machine complies with the described EU guidelines. This declaration becomes invalid if the machine is modified without our approval.

Cette machine est conforme aux normes en vigueur d'Union européenne. Cet avis est nul et non avenant si cette machine est modifiée sans notre accord.

Esta máquina, anteriormente mencionada, cumple con los límites requeridos por el reglamento UE. Ahora bien, esta declaración quedará invalidada en caso de realizar modificaciones al aparato sin nuestra aprobación.

Hiermee wordt bevestigd dat bovengenoemde machine voldoet aan de voorgeschreven EU normen. Deze verklaring verliest geldigheid als er zonder onze uitdrukkelijke toestemming wijzigen aan de machine worden aangebracht.

Place, date: Hamburg, 2021-05-20

Company stamp :



Signature: \_\_\_\_\_  
Sven Wassermann  
(Managing Director)



**WASSERMANN**  
DENTAL-MASCHINEN GMBH  
Rudorffweg 15-17 · 21031 Hamburg

Notes:



Wassermann Dental-Maschinen GmbH  
Rudorffweg 15–17 · 21031 Hamburg · Germany  
Phone: +49 (0)40 730 926-20/ -24 · Fax: +49 (0)40 730 37 24  
export@wassermann-dental.com · www.wassermann.hamburg



/WassermannDentalmaschinen