



Industrial design patent No.: CN 201130027363.1

Please read this manual before operating

# UDS-J2 LED ULTRASONIC SCALER

## INSTRUCTION MANUAL

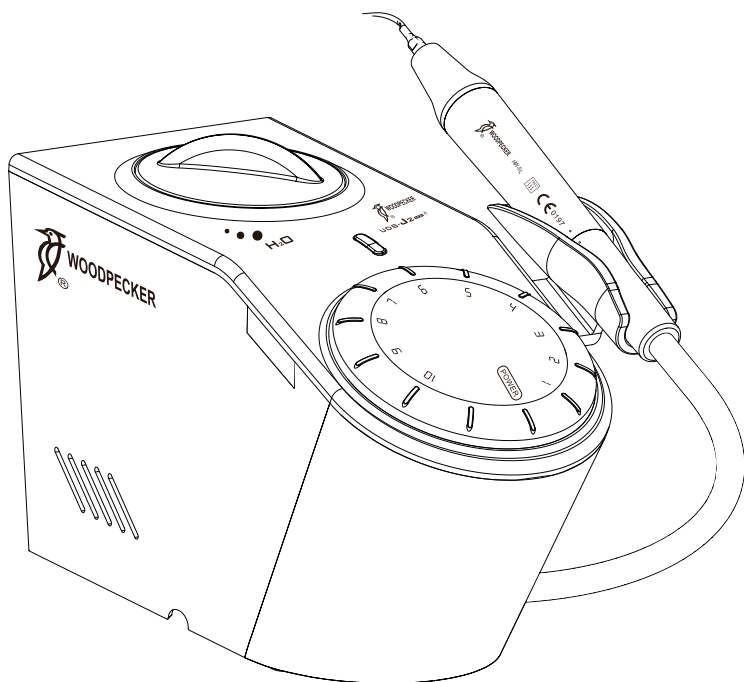

[www.glwoodpecker.com](http://www.glwoodpecker.com)

**GUILIN WOODPECKER MEDICAL INSTRUMENT CO., LTD.**

[www.stomshop.pro](http://www.stomshop.pro)

## Content

1. The installation and components of equipment .....	1
2. Installation and adjustment .....	4
3. Maintenance .....	5
4. Cleaning, Disinfection and Sterilization .....	8
5. Precaution .....	14
6. After service .....	15
7. Environmental protection .....	16
8. Manufacturer's right .....	16
9. Symbol instruction .....	16
10. Statement .....	17

## **1. The installation and components of equipment**

### 1.1 Instruction

Guilin Woodpecker Medical Instrument Co., Ltd. is a professional manufacturer in researching, developing and producing ultrasonic scalers. The product is mainly used for teeth cleaning and also an indispensable equipment for teeth disease prevention and treatment.

The ultrasonic scaler UDS-J2 LED has scaling, perio functions with the following features:

1.1.1 The handpiece is detachable and can be autoclaved to the high temperature of 134°C and the pressure of 0.22MPa.

1.1.2 Automatic frequency tracking ensures that the machine always works on the best frequency and more steadily.

1.1.3 Digital control, easy operation and more efficient for scaling.

### 1.2 Components

1.2.1 The components of machine are listed in the packing list.

1.2.2 Product performance and structural composition

Ultrasonic scaler UDS-J2 LED is composed of electrocircuit, water way and ultrasonic transducer.

1.2.3 Scope of application

Ultrasonic scaler UDS-J2 LED is used for the dental calculus elimination.

### 1.3 The main technical specifications

1.3.1 Technical specifications of ultrasonic scaler

- a) Main unit input: 220-240V~ 50Hz/60Hz 150mA
- b) Output primary tip vibration excursion:  $\leq 100\mu\text{m}$
- c) Output half-excursion force:  $< 2\text{N}$
- d) Output tip vibration frequency:  $28\text{kHz} \pm 3\text{kHz}$
- e) Output power: 3W to 20W
- f) Main unit fuse: T0.5AL 250V
- g) Water pressure: 0.01MPa to 0.5MPa
- h) Weight of main unit: 1.7kg
- i) Operating mode: Continuous operation
- j) Type of protection against electric shock: class II equipment
- k) Degree of protection against electric shock: Type BF applied part
- l) Applied part of the equipment: handpiece and tip
- m) Degree of protection against harmful ingress of water: Ordinary equipment, the foot switch is drip-proof equipment (IPX1)
- n) Degree of safety of application in the presence of a Flammable Anesthetic Mixture with air, Oxygen or Nitrous Oxide: Equipment not

suitable for being used in the presence of a flammable anesthetic mixture with air, oxygen or nitrous oxide.

#### 1.4 Instruction of the main components

Instruction and component sketch map

##### 1.4.1 Front of the main unit sketch map

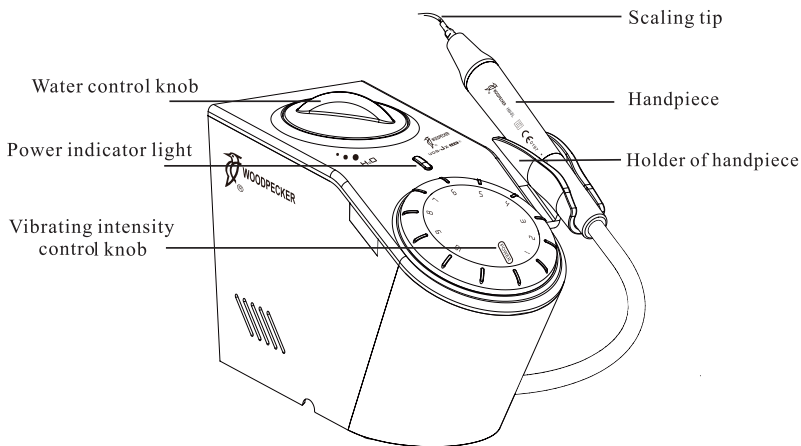

picture 1

##### 1.4.2 Back of the main unit sketch map

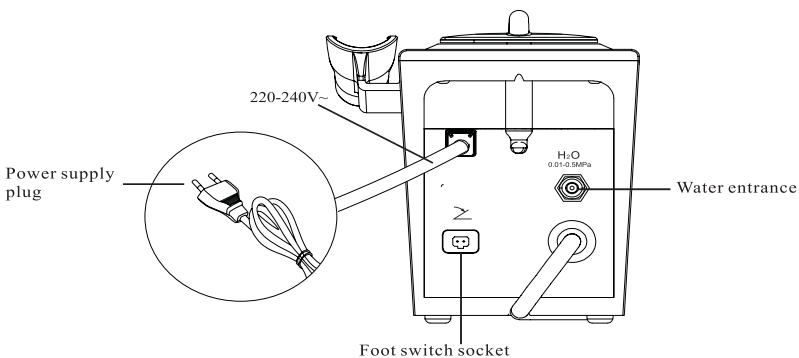

Picture 2

### 1.4.3 Sketch map for connection of water supply system

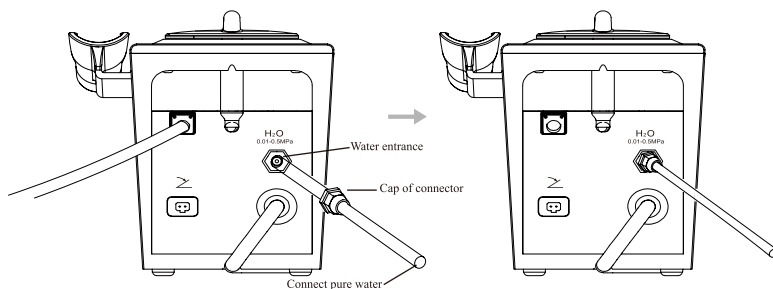

picture 3

### 1.4.4 Sketch map for connection of detachable handpiece

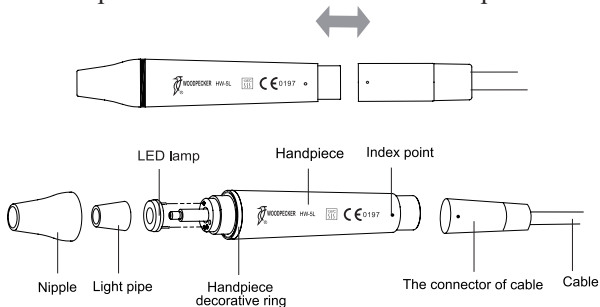

picture 4

### 1.4.5 Sketch map for how to install tip with wrench

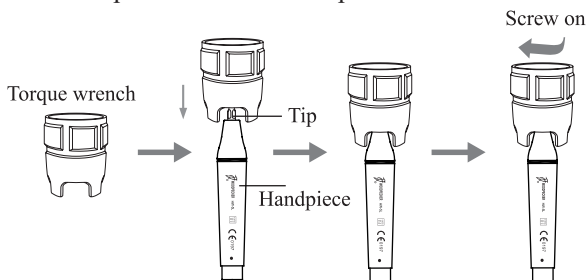

picture 5

## **2. Installation and adjustment**

### 2.1 Operation

2.1.1 Open the packing box, make sure that all the parts and accessories are complete according to the packing list, take the main unit out of the box, and put it on the the stable plane facing to the operator.

2.1.2 Turn the water control knob to the max according to the picture direction, Do not screw it over tight in case of damage. [ note 1]

2.1.3 Insert the plug of the foot switch to its socket. (see picture 2)

2.1.4 Connect one end of the water pipe to the water entrance, and the other end to the clean water source. (see picture 3)

2.1.5 Screw the scaling tip tightly to handpiece by torque wrench, then connect the handpiece and the connector of cable correctly. (see picture 4)

2.1.6 Choose the scaling tip according to the requirement, and fix the scaling tip with the wrench. ( see picture 5)

2.1.7 Turn on the power switch in the clockwise direction till hearing a "click" sound, and the power indicator lighted and the machine is ready for work.

2.1.8 Under normal working condition, the frequency of the tips is very high, light touch and a certain to-and-fro motion will eliminate the tartar without obvious heating, overexetion and overstay are forbidden.

2.1.9 Vibrating intensity: Adjust the vibrating intensity according to your need, usually adjust to the middle grade, and adjust the vibrating during the clinical treatment according to the patient's sensitivity and the rigidity of the tartar.

2.1.10 Step on the foot switch, the tip begins to vibrate, and the LED lamp on the top of the handpiece shines. Release the foot switch, the LED lamp keep shining for 10 seconds.

2.1.11 Water volume adjustment: Step on the foot switch, and the tip begins to vibrate, then turn the water control switch to fine spray to cool down the handpiece and clean the teeth.

2.1.12 The handpiece can be handled in the same gesture as a pen in hand.

2.1.13 Be sure not to make the end of the tip touch the teeth vertically, and not use too much pressure when the tip touch the surface of the teeth, in order not to hurt the teeth and the tip.

2.1.14 After finishing operation, keep the machine working for 30 seconds with the water supply to clean the handpiece and the tip.

2.1.15 Unscrew the scaling tip and pull out handpiece, then sterilize them.

**Note: Don't screw the scaling tips when stepping on the foot switch, and the machine is working.**

#### 2.2 Instruction for main components of detachable handpiece (showed in picture 4)

a) Nipple: The nipple can be removed. You can screw off the nipple and clean the pole with alcohol termly.

b) Decorative ring: can be disassembled and cleaned with alcohol regularly, can be autoclaved under the high temperature and pressure.

c) Handpiece: The main part of the whole handpiece, can be autoclaved under the high temperature and pressure.

d) The connector of the cable: Connect the handpiece with the water source and power supply of the main unit.

**Notice: Keep connector dry.**

### **3. Maintenance**

#### 3.1 Troubleshooting

Fault	Possible	Solutions
The scaling tip doesn't vibrate and no water flowing out when stepping on the foot switch.	The plug is in loose or wrong contact.	Connect the power plug well.
	The foot switch is in loose contact.	Connect the switch well.
	The fuse is broken.	Change a new T0.5AL 250V fuse.
The scaling tip doesn't vibrate, but there is water flowing out when stepping on the foot switch.	The scaling tip is in loose contact.	Screw it tightly (see picture 5)
	The connector plug of the handpiece with the circuit board is in loose contact.	Contact with the local distributor or manufacturer.
	Malfunction of the handpiece.	Contact with the local distributor or manufacturer.

Fault	Possible	Solutions
The scaling tip vibrates but there is no spray come out when stepping on the foot switch.	The water control switch is off.	Turn on the switch [note 1].
	There is impurity in the solenoid valve.	Contact with the local distributor or manufacturer.
	The water pipe is jammed.	Clean water pipe by multi-function syringe [note 2].
There is water flow out when turn off the power.	There is impurity in the solenoid valve.	Contact with the local distributor or manufacturer.
The handpiece generates heat.	The amount of spouting water is too little.	Turn the water control switch to a higher grade [note 1].
	The potentiometer is broken.	Change a new one.
The amount of spouting water is too little.	The water control knob is a low grade.	Turn the knob to a high grade [note 1].
	The water pressure is not enough.	Enhance the water pressure.
	The water pipe is jammed.	Clean water pipe with multi-function syringe [note2].
The vibration of the tip becomes weak.	The tip hasn't been screwed tightly or becomes loose because of vibration.	Screw the scaling tip tightly (picture 3).
	The coupling between the handpiece and the cable isn't dry.	Dry it by the hot air.
	The tip is damaged [ note 3 ].	Change a new one.



Fault	Possible	Solutions
The vibrating intensity control knob is seized up.	The potentiometer is damaged.	Contact with the local distributor or our company.
There is water seeping from the coupling between the handpiece and the cable.	The waterproof “O” ring is damaged.	Change a new "O" ring.

If the troubles still can't be solved, please contact with the local distributors or manufacturer.

### 3.2 Notice

[Note 1] The water control knob can adjust the water volume according to the symbol.

[Note 2] To clean the water pipe with the multi-function syringe of the dental unit (see picture 6):

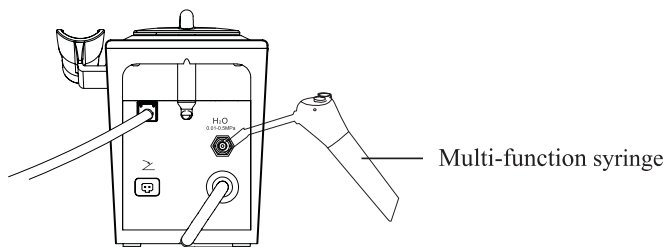

picture 6

- Snip the water pipe at a distance of 10cm to 20cm from the water entrance.
- Turn on the power switch, get through to the power.
- Connect the multi-function syringe of the dental unit to the water pipe.
- Screw off the scaling tip .
- Step on the foot switch.
- Turn on the switch of the multi-function syringe, press the air or water into the water pipe to clean and eliminate the impurity.

[Note 3 ] If the scaling tip has been screwed on tightly and there is fine spray too, the following phenomena show that the scaling tip is damaged:

- a) The vibrating intensity and the pulverization degree become weak obviously.
- b) During operating, there is some buzz when the scaling tip is working.

#### **4. Cleaning, Disinfection and Sterilization**

The cleaning, disinfection and sterilization of handpiece, tip, and wrench (include torque wrench and Endo wrench) are as follow.

Unless otherwise stated, they will be hereinafter referred to as “products”.

##### **Warnings**

The use of strong detergent and disinfectant (alkaline pH>9 or acid pH <5) will reduce the life span of products. And in such cases, the manufacturer takes no responsibility.

Do not clean the handpiece with ultrasound cleaning machine.

This device shall not be exposed to high temperature above 138°C.

##### **Processing limit**

The products have been designed for a large number of sterilization cycles. The materials used in manufacture were selected accordingly. However with every renewed preparation for use, thermal and chemical stresses will result in ageing of the products. The maximum number of sterilizations for handpiece is 600 times. For tips, it is 300 times. And for wrench, it is 1000 times.

#### 4.1 Initial processing

##### 4.1.1 Processing principles

It is only possible to carry out effective sterilization after the completion of effective cleaning and disinfection. Please ensure that, as part of your responsibility for the sterility of products during use, only sufficiently validated equipment and product-specific procedures are used for cleaning/disinfection and sterilization, and that the validated parameters are adhered to during every cycle.

Please also observe the applicable legal requirements in your country as well as the hygiene regulations of the hospital or clinic, especially with regard to the additional requirements for the inactivation of prions.

##### 4.1.2 Post-operative treatment

The post-operative treatment must be carried out immediately, no later than 30 minutes after the completion of the operation. The steps are as follows:

1. Let the Ultrasonic Scaler works for 20-30 seconds at maximum water volume to flush the handpiece and tip;
2. Remove the handpiece from the Ultrasonic scaler, and rinse away the

dirt on the surface of product with pure water (or distilled water/deionized water);

3. Dry the product with a clean, soft cloth and place it in a clean tray.

Notes

a) The water used here must be pure water, distilled water or deionized water.

#### 4.2 Preparation before cleaning

Steps

Tools: Torque wrench, tray, soft brush, clean and dry soft cloth.

1. Remove the tip from product with torque wrench provided by Guilin Woodpecker Medical Instrument Co., Ltd, and then put the tip and wrench into a clean tray.

2. Unscrew the nipple of product counterclockwise, remove the sealing ring, light pipe(if any) , and LED lamp(if any), and put them in the tray.

3. Use a clean soft brush to carefully brush the joints between product and the connector of cable, front thread, horn, nipple, seal ring, light pipe (if any) and LED lamp(if any) until the dirt on surface is not visible. Then use soft cloth to dry the product and accessories and put them into a clean tray. The cleaning agent can be pure water, distilled water or deionized water.

Disassembling steps

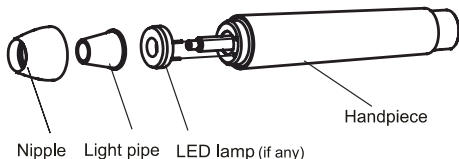

#### 4.3 Cleaning

The cleaning should be performed no later than 24 hours after the operation.

The cleaning can be divided into automated cleaning and manual cleaning. Automated cleaning is preferred if conditions permit.

##### 4.3.1 Automated cleaning

- The cleaner is proved to be valid by CE certification in accordance with EN ISO 15883.

- There should be a flushing connector connected to the inner cavity of the product.

- The cleaning procedure is suitable for the product, and the irrigating period is sufficient.

- Do not clean the handpiece with ultrasound.

It is recommended to use a washer-disinfector in accordance with EN ISO 15883. For the specific procedure, please refer to the automated

disinfection section in the next section “Disinfection”.

#### Notes

a) The cleaning agent does not have to be pure water. It can be distilled water, deionized water or multi-enzyme. But please ensure that the selected cleaning agent is compatible with the product.

b) In washing stage, the water temperature should not exceed 45 °C, otherwise the protein will solidify and it would be difficult to remove.

c) After cleaning, the chemical residue should be less than 10mg / L.

#### 4.4 Disinfection

Disinfection must be performed no later than 2 hours after the cleaning phase. Automated disinfection is preferred if conditions permit.

##### 4.4.1 Automated disinfection-Washer-disinfector

•The washer-disinfector is proved to be valid by CE certification in accordance with EN ISO 15883.

•Use high temperature disinfection function. The temperature does not exceed 134 ° C, and the disinfection under the temperature cannot exceed 20 minutes.

•The disinfection cycle is in accordance with the disinfection cycle in EN ISO 15883.

Cleaning and disinfecting steps by using Washer-disinfector

1. Carefully place the product into the disinfection basket. Fixation of product is needed only when the product is removable in the device. The products are not allowed to contact each other.

2. Use a suitable rinsing adaptor, and connect the internal water lines to the rinsing connection of the washer-disinfector.

3. Start the program.

4. After the program is finished, remove the product from the washer-disinfector, inspect (refer to section “Inspection and Maintenance”) and packaging (refer to chapter “Packaging”). Dry the product repeatedly if necessary (refer to section “Drying”).

#### Notes

a) Before use, you must carefully read the operating instructions provided by the equipment manufacturer to familiarize yourself with the disinfection process and precautions.

b) With this equipment, cleaning, disinfection and drying will be carried out together.

c) Cleaning: (c1) The cleaning procedure should be suitable for the product to be treated. The flushing period should be sufficient (5-10 minutes). Pre-wash for 3 minutes, wash for another 5 minutes, and rinse it for twice with each rinse lasting for 1 minute. (c2) In the washing stage, the water temperature should not exceed 45 °C, otherwise the protein will

solidify and it is difficult to remove. (c3) The solution used can be pure water, distilled water, deionized water or multi-enzyme solution, etc., and only freshly prepared solutions can be used. (c4) During the use of cleaner, the concentration and time provided by manufacturer shall be obeyed. The used cleaner is neodisher MediZym (Dr. Weigert).

d) Disinfection: (d1) Direct use after disinfection: temperature  $\geq 90^{\circ}\text{C}$ , time  $\geq 5$  min or  $A0 \geq 3000$ .

(d2) Sterilize it after disinfection and use: temperature  $\geq 90^{\circ}\text{C}$ , time  $\geq 1$  min or  $A0 \geq 600$ .

(d3) For the disinfection here, the temperature is  $93^{\circ}\text{C}$ , the time is 2.5 min, and  $A0 > 3000$ .

e) Only distilled or deionized water with a small amount of microorganisms ( $< 10$  cfu/ml) can be used for all rinsing steps. (For example, pure water that is in accordance with the European Pharmacopoeia or the United States Pharmacopoeia).

f) After cleaning, the chemical residue should be less than  $10\text{mg} / \text{L}$ .

g) The air used for drying must be filtered by HEPA.

h) Regularly repair and inspect the disinfectant.

#### 4.5 Drying

If your cleaning and disinfection process does not have an automatic drying function, dry it after cleaning and disinfection.

##### Methods

1. Spread a clean white paper (white cloth) on the flat table, point the product against the white paper (white cloth), and then dry the product with filtered dry compressed air (maximum pressure 3 bar). Until no liquid is sprayed onto the white paper (white cloth), the product drying is completed.

2. It can also be dried directly in a medical drying cabinet (or oven). The recommended drying temperature is  $80^{\circ}\text{C} \sim 120^{\circ}\text{C}$  and the time should be 15~40 minutes.

##### Notes

a) The drying of product must be performed in a clean place.

b) The drying temperature should not exceed  $138^{\circ}\text{C}$ ;

c) The equipment used should be inspected and maintained regularly.

#### 4.6 Inspection and maintenance

In this chapter, we only check the appearance of the product. After inspection, if there is no problem, the handpiece should be immediately reassembled, installing the sealing ring, LED, light guide, and cone head in sequence to the handpiece, and then tighten the cone head clockwise.

4.6.1 Check the product. If there is still visible stain on the product

after cleaning/disinfection, the entire cleaning/disinfection process must be repeated.

4.6.2 Check the product. If it is obviously damaged, smashed, detached, corroded or bent, it must be scrapped and not allowed to continue to be used.

4.6.3 Check the product. If the accessories are found to be damaged, please replace it before use. And the new accessories for replacement must be cleaned, disinfected and dried.

4.6.4 If the service time (number of times) of the product reaches the specified service life (number of times), please replace it in time.

#### 4.7 Packaging

Install the disinfected and dried product and quickly package it in a medical sterilization bag (or special holder, sterile box).

Notes

- a) The package used conforms to ISO 11607;
- b) It can withstand high temperature of 138 °C and has sufficient steam permeability;
- c) The packaging environment and related tools must be cleaned regularly to ensure cleanliness and prevent the introduction of contaminants;
- d) Avoid contact with parts of different metals when packaging.

#### 4.8 Sterilization

Use only the following steam sterilization procedures (fractional pre-vacuum procedure\*) for sterilization, and other sterilization procedures are prohibited:

- The steam sterilizer complies with EN13060 or is certified according to EN 285 to comply with EN ISO 17665;
- The highest sterilization temperature is 138 °C;
- The sterilization time is at least 4 minutes at a temperature of 132°C/134°C and a pressure of 2.0 bar ~ 2.3 bars.
- Allow a maximum sterilization time of 20 minutes at 134 °C.

Verification of the fundamental suitability of the products for effective steam sterilization was provided by a verified testing laboratory.

Notes

- a) Only products that have been effectively cleaned and disinfected are allowed to be sterilized;
- b) Before using the sterilizer for sterilization, read the Instruction Manual provided by the equipment manufacturer and follow the instructions.
- c) Do not use hot air sterilization and radiation sterilization as this may

result in damage to the product;

d) Please use the recommended sterilization procedures for sterilization. It is not recommended to sterilize with other sterilization procedures such as ethylene oxide, formaldehyde and low temperature plasma sterilization. The manufacturer assumes no responsibility for the procedures that have not been recommended. If you use the sterilization procedures that have not been recommended, please adhere to related effective standards and verify the suitability and effectiveness.

\* Fractional pre-vacuum procedure = steam sterilization with repetitive pre-vacuum. The procedure used here is to perform steam sterilization through three pre-vacuums.

#### 4.9 Storage

1. Store in a clean, dry, ventilated, non-corrosive atmosphere with a relative humidity of 10% to 93%, an atmospheric pressure of 70KPa to 106KPa, and a temperature of -20 °C to +55 °C;

2. After sterilization, the product should be packaged in a medical sterilization bag or a clean sealing container, and stored in a special storage cabinet. The storage time should not exceed 7 days. If it is exceeded, it should be reprocessed before use.

Notes:

a) The storage environment should be clean and must be disinfected regularly;

b) Product storage must be batched and marked and recorded.

#### 4.10 Transportation

1. Prevent excessive shock and vibration during transportation, and handle with care;

2. It should not be mixed with dangerous goods during transportation.

3. Avoid exposure to sun or rain or snow during transportation.

**The cleaning and disinfection of main unit are as follows.**

- Before each use, wipe the surface of the main unit, the connector of cable and cable with a soft cloth or paper towel soaked in 75% medical alcohol. Repeat the wipe for at least 3 times.

- Before each use, please let the Ultrasonic scaler works for 20-30 seconds at maximum water volume, then install the handpiece.

- After each use, please let the Ultrasonic scaler works for 20-30 seconds at maximum water volume, then remove the handpiece.

- After each use, wipe the surface of the main unit, the connector of cable and cable with a soft cloth soaked in clean water (distilled or deionized water) or a clean disposable wipe. Repeat the wipe for at least 3 times.

## **5. Precaution**

### 5.1 usage notice

5.1.1 Keep the scaler clean before and after operation.

5.1.2 The scaling tip, wrench and handpiece must be sterilized before each treatment.

5.1.3 Don't screw the scaling tip when stepping on the foot switch.

5.1.4 The scaling tip must be fastened. There must be fine spray coming out from the tip when operating.

5.1.5 Change a new one when the tip is damaged or worn excessively.

5.1.6 Don't twist or rub the tip.

5.1.7 While scaler is working, the heat of scaling tip will become higher if there is no water flowing out, please keep the water flow smoothly.

5.1.8 Don't use impure water source, and be sure not to use normal brine instead of pure water source.

5.1.9 If use the water source without hydraulic pressure, the water surface should be one meter higher than the head of the patient.

5.1.10 Keep the connector of handpiece and the socket of the cable dry before installing the handpiece.

5.1.11 Don't knock or rub the handpiece.

5.1.12 Please put the power plug into the socket easy to pull out, to make sure it can be pulled out in emergency.

5.1.13 When using the equipment, please keep the water get through smoothly, otherwise patient's tooth surface would be injured by overheat in the handpiece.

5.1.14 After finishing operation, turn off electrical source, and then pull out the plug.

5.1.15 As a professional manufacturer of medical instruments, we are only responsible for the safety on the following conditions:

I. The maintenance, repair and modification are made by the manufacturer or the authorized dealer.

II. The changed components are original of "WOODPECKER" and operated correctly according to instruction manual.

5.1.16 The screw thread of the scaling tips produced by other manufacturers maybe coarse, rusty and collapsed, which will damage the screw thread of the handpiece irretrievably. Please use "WOODPECKER" brand scaling tip.

5.1.17 Please select a suitable power when using different type of tips (refer to "TABLE OF OPERATING POWER OF THE TIPS").



## 5.2 Contraindication

5.2.1 The patient who has hemophilia is not allowed to use this equipment.

5.2.2 The patient or doctor who are with heart pacemaker is forbidden to use this equipment.

5.2.3 The heart disease patient, pregnant woman and children should be cautious to use the equipment.

## 5.3 Storage and maintenance

5.3.1 The equipment should be handled carefully and lightly. Be sure that it is far from the vibration, and is installed or kept in a cool, dry and ventilated place.

5.3.2 Don't store the machine together with the articles that are combustible poisonous, caustic, or explosive.

5.3.3 This equipment should be stored in a room where the relative humidity is  $\leq 93\%$ , atmospheric pressure is 70kPa to 106kPa, and the temperature is  $-20^{\circ}\text{C}$  to  $+55^{\circ}\text{C}$ .

5.3.4 Please turn off the power switch and pull out the power plug when the equipment is not used. If the machine is not used for a long time, please make it get through to the power and water once per month for five minutes.

## 5.4 Transportation

5.4.1 Excessive impact and shake should be prevented in transportation. Lay it carefully and lightly and don't invert it.

5.4.2 Don't put it together with dangerous goods during transportation.

5.4.3 Avoid solarization and getting wet in rain or snow during transportation.

## 5.5 Working condition

Environment temperature:  $+5^{\circ}\text{C}$  to  $+40^{\circ}\text{C}$

Relative humidity:  $\leq 93\%$

Atmosphere pressure: 70kPa to 106kPa

## **6. After service**

We offer one year free repair to the equipment according to the warranty card.

The repair of the equipment should be carried out by professional technician. We are not responsible for any irretrievable damage caused by the unprofessional person.



















## 7. Environmental protection

There are no harmful factors in our product. You can deal with it based on the local law.

## 8. Manufacturer's right

We reserve the rights to change the design of the equipment, the technique, fittings, the instruction manual and the content of the original packing list at any time without notice. If there are some differences between blueprint and real equipment, take the real equipment as the norm.

## 9. Symbol instruction

 <b>WOODPECKER</b> Trademark	 Consult the accompanying documents
<b>IPX1</b> Anti-drip device	<b>IPX0</b> Ordinary equipment
 Alternating current	 Foot switch interface
 Date of manufacture	 Manufacturer
 Class II equipment	 Type BF applied part
 serial number	 Used indoor only
 Adjustment for the water flow	 Appliance compliance WEEE directive
 Recovery	 Keep dry
 Handle with care	 $H_2O$ 0.01Mpa-0.5MPa Water entrance pressure
 Humidity limitation 10% 93%	 $+55^{\circ}C$ $-20^{\circ}C$ Temperature limitation
 Atmospheric pressure for working/storage 70kPa 106kPa	

## **10. Statement**

All rights of modifying the product are reserved to the manufacturer without further notice. The pictures are only for reference. The final interpretation rights belong to GUILIN WOODPECKER MEDICAL INSTRUMENT CO., LTD. The industrial design, inner structure, etc, have claimed for several patents by WOODPECKER, any copy or fake product must take legal responsibilities.

**TABLE OF OPERATING POWER OF THE TIPS  
(UDS-J2 LED )**

(The tips compatible with WOODPECKER & EMS Ultrasonic Scalers)

Scaling	
Tip Model	Power
G1	1-10
G2	1-10
G3	1-10
G4	1-10
G5	1-10
G6	1-10
G7	1-10
G8	1-10
G9	1-10
G10	1-10
G11	1-10

Periodontics	
Tip Model	Power
P1	1-7
P2L	1-2
P2LD	1
P2R	1-2
P2RD	1
P3	1-4
P3D	1-4
P4	1-4
P4D	1-4

Endodontics	
Tip Model	Power
E1	-
E2	-
E3	-
E3D	-
E4	-
E4D	-
E5	-
E5D	-
E8	-
E9	-
E10	-
E10D	-
E11	-
E11D	-
E14	-
E15	-

Cavity Preparation	
Tip Model	Power
SB1	1-7
SB2	1-7
SB3	1-7
SBL	1-7
SBR	1-7

Scan and Login website  
for more information



Guilin Woodpecker Medical Instrument Co., Ltd.  
Information Industrial Park, Guilin National High-Tech  
Zone, Guilin, Guangxi, 541004 P. R. China

Tel:

Europe Sales Dept.: +86-773-5873196

North/South America & Oceania Sales Dep.:+86-773-5873198

Asia & Africa Sales Dep.:+86-773-5855350 Fax: +86-773-5822450

E-mail: woodpecker@glwoodpecker.com, sales@glwoodpecker.com

Website: <http://www.glwoodpecker.com>

ZMN-SM-134 V1.1-2020318

[www.stomshop.pro](http://www.stomshop.pro)