



Precautions for Electrical Equipment in Use

Intended Use

This product is a light-curing machine for dental laboratory use. It is not to be employed for other uses.

Installation

- [1] Only properly qualified persons should operate this product.
- [2] Follow the following precautions when installing the product:
- (1) Install the product at a location that is not exposed to water.
 - (2) Install the product at a location without excess atmospheric pressure, temperature, humidity, sunlight, dust, salt content and sulfur content.
 - (3) Do not install the product at a sloping location.
Do not shake or impact the product (including in transportation).
 - (4) Do not install the product at storage location for chemicals or a location where gas is released.
 - (5) Pay attention to the frequency of the power supply, power voltage and allowable current value (or consumed power).
 - (6) Earth the product correctly.
 - (7) Install the product on the place easy accessible when disconnecting the power cord from the outlet.

Confirmation Before Use

- [1] Read the following precautions before use:
- (1) After checking on contact status, polarity character, dial setup and meter, check to confirm that the product can be operated.
 - (2) Check to confirm that the product is completely earthed.
 - (3) Check to confirm that all the cords are connected correctly and completely.
- [2] Follow the following directions after use:
- (1) After returning the operating switch and dial to their original position according to the prescribed steps, power down.

Storage

- (1) Pay attention to following storage directions:
 - Store the product in a location that is not exposed to water.
 - Store the product in a location without excess atmospheric pressure, temperature, humidity, sunlight, dust, salt content and sulfur content.
 - Do not store the product in a sloping location.
 - Do not shake or impact the product (including in transportation).
 - Do not store the product at storage location for chemicals or a location where gas is released.
- (2) After cleaning the accessories, power cords and electrodes, store them together.
- (3) Be sure to clean the equipment for next use.
- (4) Do not store in the place for hazardous substances and / or ignition material.

Services

- [1] In case of malfunction, do not attempt to repair the product yourself. Label the defect properly and bring the product to qualified professionals for repair.
- [2] Maintenance and Inspection
- (1) Be sure to conduct regular inspections of the equipment and parts.
 - (2) When reusing equipment after an interval of some time, check to confirm that it can be operated normally and safely before use.

DECLARATION OF CONFORMITY

Manufacturer: Yamamoto Precious Metal Co., Ltd.
3-7 Sanadayama-cho Tennoji-ku
Osaka, 543-0015
Japan

Authorised Representative: Crestec Europe B.V.
110 Teleportboulevard,
1043 EJ, Amsterdam,
The Netherlands

Product: LED CURE Master

Model: DLC-2000

We herewith declare that the above mentioned product meets the provisions of the following council directives..

The Directives Covered by this Declaration: LOW VOLTAGE DIRECTIVE 2006/95/EC
Electromagnetic Compatibility DIRECTIVE 2004/108/EC
The RoHS Directive 2011/65/EU

Applied Harmonized Standards: IEC 62471 :ed1
EN 61010-1:2010(3rd)
EN61326-1-2006
EN55011:2009+A1:2010
EN61000-3-2 :2006+A1 :2009+A2 :2009
EN61000-3-3 :2008
EN61000-4-2 :2009
EN61000-4-3 :2006+A1 :2008+A2 :2010
EN61000-4-4 :2012
EN61000-4-5 :2006
EN61000-4-6 :2009
EN61000-4-8 :2010
EN61000-4-11 :2004

The CE mark was first applied in : 2014

PLACE, DATE OF ISSUE Osaka, JAPAN, 2014-01-31

Shigenari YAMAMOTO
Executive Vice President

Authorised Representative

Crestec Europe B.V.

110 Teleportboulevard, 1043 EJ, Amsterdam, The Netherlands

Yamamoto Precious Metal Co., Ltd.

Head Office: 3-7 Sanadayama-cho Tennoji-ku Osaka 543-0015, Japan

Branch Office: Tokyo, Osaka, Sendai, Nagoya, Fukuoka, JAPAN

Factory and R&D: Kochi, JAPAN

P: +81-6-6761-8338 F: +81-6-6761-4743

E: contact@yamakin-gold.co.jp

<http://www.yamakin-global.com>



ISO 9001/13485
ISO 14001

CERTIFIED



Scope:
Headquarters and Kochi Plant



QA/QC/JP/0455
Scope : Kochi Plant

Maintenance

The following maintenance work should be done about once a week:



Before maintenance, switch off the power and pull out the plug.

When the exterior or the reflective plate of the product gets dirty, clean it with a soft cloth moistened with a diluted neutral detergent.

If any objects are in the chamber, this may interfere with the revolution of the table. Please remove them.

Cleaning and Replacement of Filter

A fan filter, which cools down the internal temperature, is attached on the bottom the product. Please vacuum off the dust on the filter using a vacuum cleaner.

If the dirt on the filter can no longer be removed or it is torn, it needs to be replaced. Please remove the filter cover and replace the old filter with a new one.

The replacement filter product is 1000M20 (5-pack). Please contact the distributor.

Use same type screws for the filter cover.

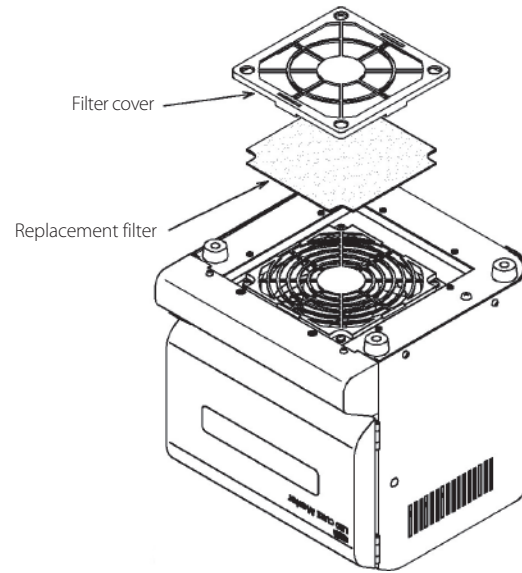

Disposal



This symbol on the product or on its packaging indicates that this product should not be disposed of with your other household waste.

For proper recycling of waste electrical and electronic equipment, take it to a designated collection points in accordance to Directive 2012/19/EU (WEEE).

The separate collection and recycling of your waste equipment will help to conserve natural resources and protect human health and the environment.

For more information, please contact your municipality, your household waste disposal service or the shop where you purchased the product.

Precautions

Before using the product, please read these 'Precautions' and follow them carefully for correct use.

Note on Labels

A number of different safety labels are displayed in the Precautions to ensure correct use and to prevent physical injury and property damage. Please make sure that you fully understand them before reading the rest of this manual.



WARNING

This warning label indicates a potentially hazardous situation, which could result in death or serious injury.



Caution

This caution label indicates a potentially hazardous situation which could result in minor injury to persons, or physical damage to the equipment due to misuse.











This label indicates that the action is prohibited. The specific actions prohibited are given in the label. (E.g., the label on the left indicates 'Disassembly prohibited'.)









This label indicates the content of orders and instructions. The specific contents of instructions are given in the label. (E.g., the label on the left indicates 'Pull out the plug'.)



This label indicates cautions. Specific contents of instructions are given in the label. (E.g., the label on the left indicates 'Pay attention: fingers may be caught in the mechanism'.)

 WARNING	General	
		<ul style="list-style-type: none"> Do not re-model the equipment. Continued operation of this product when it is in an abnormal state, such as when it is emitting smoke or an irregular noise, may cause fire and/or electrocution. Switch off the power button immediately. Be sure to pull out the plug and contact the distributor. If water leaks inside the product, switch off the power button first. Then pull out the plug and contact the distributor. Continued operation of this product may cause fire and/or electrocution. If foreign materials are found inside this product, switch off the power button first. Then pull out the plug and contact the distributor. Continued operation of this product may cause fire and/or electrocution.
		<ul style="list-style-type: none"> Do not disassemble this product except as instructed. Unauthorized disassembly of this product may cause electrocution and/or breakdown.
		<ul style="list-style-type: none"> If this product is dropped, broken or damaged, switch off the power. Then pull out the plug and contact the distributor. Continued operation of the product may cause fire and/or electrocution.
		<ul style="list-style-type: none"> Do not block the ventilators on the left, right and top of the product. Blockage may cause fire and/or breakdown due to internal temperature rise.
	Installation	
		<ul style="list-style-type: none"> Use only indicated power-supply voltage (AC230V). Use of the wrong voltage may cause fire and/or electrocution.
		<ul style="list-style-type: none"> Please install the product at least 5cm away from the wall. Also, do not place any objects above the product. Please keep the product away from other heating appliances. Overheating of the product may cause fire and/or electrocution.
	Power Cords	
		<ul style="list-style-type: none"> Do not place heavy objects on the power cord and take note that the power cord must not be placed under the product. Damage to the cord may cause fire and/or electrocution. Do not damage, bend, twist or pull the power cord or submit it to any form of processing. Doing so may cause fire and/or electrocution.

 Caution	Storage	
		<ul style="list-style-type: none"> If this product is not going to be used for a long time, such as over a vacation period, etc., please pull out the plug for safety. Be sure to pull out the plug for safety in maintaining the product.
	Power Cords	
		<ul style="list-style-type: none"> Do not insert or remove the plug with wet hands. Doing so may cause electrocution. When pulling out the plug, do not pull it out by the cord. Doing so may cause fire and/or electrocution, so make sure to pull out the plug, not the power cord.
	Precaution in Use	
		<ul style="list-style-type: none"> Do not look inside the product during operation. Doing so may cause adverse effects on the eyes by oblique illumination.
		<ul style="list-style-type: none"> When transferring the product, please switch off the power button and pull out the plug. Damage to the cord may cause fire and/or electrocution.
	<ul style="list-style-type: none"> Do not operate the interlock switch while the door is opened. Operating the interlock switch while the door is opened during operation may lead to damage to vision. 	

Troubleshooting

LED is blinking after curing is complete.

- Have any objects been placed beside or on the product?
- Some of the LED lamps for curing are not blinking.

- Remove them.
- Contact the distributor.

FIL is blinking after curing is complete.

- Have any objects been placed beside or on the product?
- The filter at bottom of the product needs to be cleaned.

- Remove them.
- Refer to 'Maintenance' .

E1 , **E2** , **E3** or **E4** is displayed.

- Contact the distributor regarding displayed contents. The product is in need of repair.

There is dark matter on the LED lamp. The LED lamp seems to be about to stop functioning.

- In order to guarantee the appropriate wavelength, this product is equipped with two types of LED lamp.

- Of the total of 40 LED lamps, eight may seem to emit relatively little light during operation. This is normal functioning for these lamps, and is not a cause for concern.

Specifications

Name of Product :	LED CURE MASTER
Model :	DLC-2000
Operational conditions :	Temperature: 5 to 40 °C, Humidity: 10 to 95% RH (with no condensation) Altitude: max. 2000 m
Operating Voltage and Frequency :	230 V ~ 50 Hz
Power Consumption :	160 VA
Number of Courses :	4 courses
Curing time :	5 to 995 sec.
Drying Time :	5 to 995 sec (course 4 only)
Revolutions per min :	10 rpm (60Hz), 8.3 rpm(50Hz)
Dimensions :	210(W)×220(H)×223(D) mm
Dimensions of chamber :	135(W) ×77(H) ×135(D) mm
Mass :	5.4 kg
Emission Wavelength :	375 to 495 nm
Quantity of Power LED lamps :	40
Insulation Class :	Class I

Setting of System Program

The system can be set for features such as whether the table is rotated or not during curing. Also, different buzzer sounds can be chosen and the operation stop buzzer can be changed.

You will be able to discriminate by sound which machine has stopped if you are using multiple machines at the same time.

Hold down the button for the course you would like to change for about 1 sec.

1. Table Rotation and Operations after opening and closing the door.



- The upper column of indicator indicates rotation. The lower column displays
- Choose the or using the Λ and V buttons and press the Start/Stop button.
- After displaying , display . (Default)
- Choose the or using the Λ and V buttons and press the Start/Stop button.
- indicates if curing has re-recommended when door is closed after being opened.
- indicates that curing has stopped.

2. Buzzer sound settings (same for each course)

- Hold down the button for the course you would like to change for about 1 sec. and press the Start/Stop button three times.
- Display . You can choose from to using the Λ and V buttons.
Set up is performed according to the following table:
- : Disable buzzer sound
- : Ring curing completion sound only
- : Ring curing completion sound and error sound
- : Ring curing completion sound, error sound and enter key sound
- Press the Start/Stop button
- Next, enter the ending buzzer setup
- Display . 9 kinds of ending buzzer sound can be chosen using the Λ and V buttons.
- The sound of is a long beep.
- The sound of is a long beep followed by a bip.
- The sound of is a long beep followed by four bips.
- Press the Start/Stop button after setup is complete.

Recommended Procedure when Opening Product Packaging

Please confirm the accessories listed below after opening the product packaging. Also, please check to see if there are any scratches, dents etc. on these accessories. If there are any problems, please contact the distributor immediately.

Accessories		
Name	Illustration	pcs.
Tray		1
Large Pin		5
Small Pin		5
Instruction Manual	-	1

Please retain the packaging material with its cushioning.

Part Names and Functions

- Power switch : Power switch of this product
 Operation Panel : Operates program on each course
 Door : Door of treatment chamber; photo-radiation ceases if the door is opened during operation protected by interlock switch.

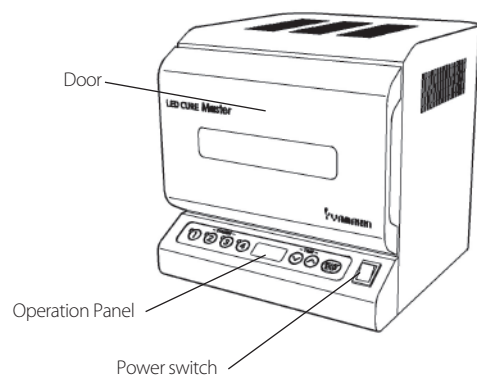

Functions of Operation Panel



- Course Button : Selects the course from 1 to 4; drying time can be programmed in course 4.
 Triple-digit Indicator : Displays the curing time; the indicator indicates the remaining curing time as a countdown, in units of seconds.
 Up-and-Down arrow button : Changes the curing time and drying time in each course.
 START/STOP button : Start button for curing; if the button is pushed during operation, it halts.

Preparation Before Use

Installation

Location · Environmental conditions

- Install the product on a secure horizontal surface.
 Please install it at least 5cm away from the wall and other equipment on either side.
 Also, do not place any objects on the product.

Preparation of Power Source

The product is for use with an 230 V ~ source. Please plug in power cord to an earthed 230V outlet.

Operations

Summary of Program

- This product stores 4 different curing programs.
- When course 4 is started, in order to dry resin before light curing you can program a drying time not including photo-irradiation. After that, start light irradiation and curing.
- Unlike course 4, drying time is not included in courses 1, 2 and 3; light irradiation is started once the course is activated.

Turn on This Product for the First Time

Please turn on the product after installation.

After the **[on]** signal is displayed, the lamp for course 1 is turned on and **[10]** is displayed on the indicator as the default value.

Program Operations

The values given in the table below are pre-installed on courses 1 to 4. The contents of each course can be changed by Program Operations.

Example: In the case of changing the curing time of course 2 from 30 sec. to 50 sec.:

1. Press the course 2 button. The value **[30]** will be displayed on the indicator.
2. Display **[50]** by pressing the \wedge and V buttons.

	Drying time (sec)	Curing time (sec)
course 1	-	10
course 2	-	30
course 3	-	90
course 4	60	90

Advice : The value can be changed quickly by pressing and holding the \wedge and V buttons.

Example: In the case of changing the drying time of course 4 from 60 sec. to 100 sec. and the curing time from 90 sec. to 115 sec.

1. Press the course 4 button and chose course 4.
2. **[dry]** and **[60]** are displayed alternately; display **[100]** by pressing the \wedge and V buttons.
3. Press the course 4 button if the value displayed is correct.
4. **[cure]** and **[90]** are displayed on the indicator; display **[115]** by pressing the \wedge and V buttons at the same time.
5. Press course 4 if the value displayed is correct.

NOTE : **[dry]** means drying time (DRY) and **[cure]** means curing time (CURE).
 If course button 4 is pressed during **[dry]** or while curing time is being displayed, drying time is not changed, but the indicator shifts to "change the curing time."

Curing Operations

Choose the course and start curing.

Example : Cure in course 4 (Drying time is for 120 sec. and curing time for 90 sec. in course 4.)

1. Put a dental prosthesis on the tray provided.
 Open the door and place the tray on the rotating table in the center.
2. Close the door and choose course 4.
3. Press the Start/Stop button.
4. The indicator counts down in units of 1 sec.
5. After drying, curing time is counted down from **[90]** and light irradiation is started.
6. A buzzer rings when remaining curing time has reached 0, and curing is completed.

Other Operations During Curing

- Press the Start/Stop button during curing:
 Operations will be shut down and curing will be stopped. However, the content of the program does not change.
- Opening the door during curing:
 Light irradiation and the revolution of the table will be stopped. Also, operation of countdown will be stopped. Once the door is closed again, curing is re-commenced.

NOTE : A curing operation can be stopped by the appropriate system program settings.